

NETWORK TERMS FOR LOCAL AND MOBILE NUMBER PORTABILITY IN NEW ZEALAND

“Network Terms”

[This version is marked up, for purposes of the Final Determination, relative to the terms released for consultation as an attachment to the Draft Determination 12 May 2005.]

Formatted: Centered

Formatted: Highlight

Table Of Contents

Formatted: Highlight

Explanatory Statement

1	Purpose of the Network Terms	
1.1	Purpose.....	5
1.2	Status of Network Terms.....	5
1.3	Anticipated Benefits to Industry.....	5
2	Introduction	
2.1	Number Portability for Local and Mobile Numbers.....	6
2.2	Industry Structure.....	6
2.3	References.....	6
3	Scope and Objectives	
3.1	Scope.....	7
3.2	Objectives.....	7
3.3	General Network Requirements.....	7
4	Conventions in the Network Terms	
4.1	Interpretations.....	9
4.2	Definitions.....	10
5	Business Rules	
5.1	Non-discrimination.....	13
5.2	Privacy and Use of Information.....	13
5.3	Good Faith.....	13
5.4	Bilateral and other Agreements.....	13
6	Carrier Responsibilities	
6.1	Carrier Rules.....	15
6.2	Compliance with Service Levels.....	15
6.3	Network Planning and Design.....	15
6.4	Network Performance.....	15
6.5	Non-Participating Carriers.....	15
6.6	Emergency Voice Calls.....	16
7	Carrier Relationships and Network Model for Voice Services	
7.1	Carrier Relationships for calls made to Ported numbers.....	17
7.2	Network Model.....	17
7.3	Handover of Ported Voice Calls.....	18
8	Carrier Relationships and Network Model for Short Message Services	
8.1	Carrier Relationships for Short Messages to Ported numbers.....	19
8.2	Network Model.....	19
8.3	Handover of Ported Short Messages.....	19
9	Donor and Originating Carrier Re-routing for Voice Services	
9.1	Re-routing Responsibilities.....	21
9.2	Re-routing Rules.....	21
9.3	Call Diagrams.....	21
10	Voice Call Handling Rules	
10.1	Voice Call Handling Solution.....	25

Deleted: 6.7 [omitted] 16

11	Short Message Handling Rules	
11.1	Short Message Handling Solution	28
12	Technical Call Handover and Signalling for Voice Services	
12.1	General Inter-Network Signalling Standards	30
12.2	General Signalling Capabilities	30
12.3	Definition of Signalling Terms.....	31
12.4	Signalling for Calls to and from Ported Numbers	32
13	Hand-Off Codes	
13.1	HOC Allocation and Format	33
13.2	HOC Forwarding	33
13.3	HOC Trapping	33
14	Equivalent Service	
14.1	Definition	35
14.2	Equivalent Service Criteria for LMNP for Voice Services.....	35
14.3	Equivalent Service Criteria for MNP for Non-Voice Services	36
14.4	Equivalent Service Compliance.....	36
14.5	Enforcement Agency Audits	36
15	Process for Exemption from Compliance with the Obligations contained in the Network Terms	
15.1	Applications to the TCF Management Committee for Exemption	40
15.2	TCF Management Committee to Notify Parties of Applications and Invite Submissions.....	40
15.3	TCF Management Committee may Recommend Exemptions	40
15.4	Deciding an Application for Exemption.....	41
15.5	Compliance with the Network Terms after Applying for an Exemption	42
15.6	Notice of Decision about Relaxation	42
15.7	Applications to the Commerce Commission for Exemptions.....	42
15.8	Right of Carrier to Apply to the Commerce Commission.....	43
15.9	Confidentiality of Information.....	43
15.10	Applicant Carrier to bear TCF Management Committee Costs.....	43
16	Administrative Issues	
16.1	Clarification and Reconsideration of the Network Terms	44
16.2	Dispute Resolution	44
17	Fault Handling and Testing Procedures	
18	Capacity forecasting Procedures	
19	Support arrangements and escalation procedures	
20	New entrant procedures	
21	Audit Process	

Explanatory Statement

The **N**umber **P**orting arrangements for **L**ocal **N**umbers and **M**obile **N**umbers in New Zealand are provided for in the Commerce Commission's determination pursuant to Decision number **554**, including:

- Terms for Local and Mobile Number Portability in New Zealand (LMNP Terms)
- Network Terms for Local and Mobile Number Portability in New Zealand (Network Terms)

LMNP is a project comprising of two sets of terms and conditions, the LMNP Terms and the Network Terms. Therefore, for a party to deliver an LMNP solution in compliance with the Commerce Commission's determination, the solution will have to comply with both the LMNP Terms and the Network Terms.

The LMNP Terms detail the processes that enable end-users to **P**ort their **N**umbers and set out the rights and obligations of parties to those terms in a **N**umber portability environment. These processes are based around an Industry Portability Management System which facilitates **N**umber portability between **S**ervice **P**roviders and **C**arriers but relies on **C**arriers to configure and update their **N**etworks and support systems to ensure calls to and from **P**orted **N**umbers are correctly routed.

In a **N**umber portability environment changes are required to the traditional way in which calls are routed from originating carriers to terminating carriers. For voice services, this applies to local, national, fixed-to-mobile, mobile-to-fixed, mobile-to-mobile, incoming and outgoing international and other calls involving local or mobile numbers.

These Network Terms set out what is required of participating Carriers in the development of their own network solutions and specify the optional and mandatory requirements necessary between networks for **L**ocal and **M**obile **N**umber **P**ortability.

Deleted: n
Deleted: p
Deleted: l
Deleted: m
Deleted: n
Deleted: [specify]

Deleted: p
Deleted: n
Deleted: n
Deleted: n
Deleted: s
Deleted: p
Deleted: c
Deleted: c
Deleted: n
Deleted: p
Deleted: n
Deleted: n
Deleted: l
Deleted: m
Deleted: n
Deleted: p

1 Purpose of the Network Terms

1.1 Purpose

The purpose of these Network Terms is to provide for the Carriers' Network requirements for Local and Mobile Number Portability.

1.2 Status of Network Terms

These Network Terms are determined under the Telecommunications Act 2001, in relation to the designated multi-network services "local telephone number portability service" and "cellular telephone number portability service". The Network Terms apply to all parties to the Determination who are access seekers or access providers in relation to either of those designated multi-network services (i.e. local telephone number portability service or cellular telephone number portability service), and any person who becomes an access provider subsequent to the Determination being made.

1.3 Anticipated Benefits to Industry

The purpose of these Network Terms is to provide benefits to the industry and end-users of telecommunications services in New Zealand, including by:

- 1.3.1 Standardising industry practices in relation to the inter-network aspects of LMNP;
- 1.3.2 Ensuring that all Carriers are able to meet their call routing responsibilities so that calls to and from Customers with Ported Numbers, are routed successfully;
- 1.3.3 Ensuring service to the Customer is maintained by specifying Service Levels; and
- 1.3.4 Ensuring efficient and effective inter-Carrier operational arrangements.

1.4 Establishment of IPMS

On or before 1 February 2007, each party to the Determination must be able to connect to the IPMS and use it to test their systems and processes for:

- (a) Local Number Portability, in the case of a party who is an access seeker or an access provider in relation to local telephone number portability service; and
- (b) Mobile Number Portability, in the case of a party who is an access seeker or an access provider in relation to cellular telephone number portability service.

Deleted: 1 April 2006

2 Introduction

2.1 Number Portability for Local and Mobile Numbers

In a number portability environment, there will be changes to the traditional ways voice calls, short messages and other services are delivered from Originating Carriers to Terminating Carriers. This applies to local, long distance, mobile, international and other types of calls. The Network Terms detail these networking arrangements.

The Network Terms define the technical interconnection arrangements, operational arrangements and business rules and processes related to Porting based on a model of interconnected Networks.

2.2 Industry Structure

The supply of Local Services and Mobile Services is currently undertaken by a number of Carriers in New Zealand. In addition, new Carriers are able to obtain Local Numbers and Mobile Numbers and establish their own services.

2.3 References

2.3.1 Document References:

- a) LMNP Terms; and
- b) NAD Number Register and Number Allocation Rules.

2.3.2 Websites References:

- a) Telecommunications Carrier Forum - <http://www.tcf.org.nz/>
- b) Number Administration Deed - www.nz.m-co.com
- c) Commerce Commission - <http://www.comcom.govt.nz/telecommunications/numberportability.cfm>
- d) ACIF - <http://www.acif.org.au/publications>

3 Scope and Objectives

3.1 Scope

The Network Terms set out operational standards, procedures and processes between Carriers and Service Providers, for the origination, carriage, handover and termination of calls in an environment where Local Numbers and Mobile Numbers are able to be Ported.

- 3.1.1 The Network Terms are binding on all parties to the Determination, in accordance with the Telecommunications Act, including any person who becomes an access provider subsequent to the Determination being made.
- 3.1.2 In the event of any conflict or inconsistency between the Network Terms and any New Zealand legislation or determinations of regulatory bodies, then such legislation or determinations will prevail, to the extent of the inconsistency.
- 3.1.3 The requirements of the Network Terms are the default minimum industry standards and can be improved by Bilateral Agreements provided that those agreements do not impact on the ability of other Carriers to inter-work with parties to those arrangements in accordance with the minimum requirements.
- 3.1.4 The commercial arrangements for the handover of calls between Carriers are to be agreed consistent with the requirements of these Network Terms.
- 3.1.5 These Network Terms apply specifically to enable LMNP. Clarification or reconsideration of these Network Terms by the Commerce Commission may be sought in accordance with the Telecommunications Act.
- 3.1.6 Nothing in these Network Terms shall prevent any party from enforcing these Network Terms in accordance with section 61 of the Telecommunications Act.

Deleted: LMNP

Deleted: LMNP

3.2 Objectives

The objectives of the Network Terms are to:

- 3.2.1 Set out procedures between Carriers to enable calls to and from Ported Numbers to be routed to or from the Host Carrier's Network, notwithstanding that the relevant Number range containing the Number will still be held by the Donor Carrier;
- 3.2.2 Set out competitively neutral and non-discriminatory principles for the implementation and operation of LMNP; and
- 3.2.3 Set out procedures to ensure Equivalent Service for Voice Services and Non-voice Services.

3.3 General Network Requirements

The requirements of the Network Terms shall:

- 3.3.1 Enable Carriers, as far as possible, to remain in control of their own switching infrastructure;
- 3.3.2 Concentrate on the information to be passed between Networks (subject to the requirements for interoperability, solutions should be specified independent of specific technologies at the Network interface as far as possible);
- 3.3.3 Not preclude the use of multiple solutions within a Network, nor the use of multiple or different solutions over time;

3.3.4 Focus on interconnect in relation to Porting (inter-Network, or inter-operability) standards rather than intra-Network solutions: and

3.3.5 Encourage efficient use of Network resources in relation to Porting.

Deleted: A

4 Conventions in the Network Terms

4.1 Interpretations

In the Network Terms:

- 4.1.1 Sections, clauses and other headings are for ease of reference only and will be ignored in construing the Network Terms;
- 4.1.2 Unless the context otherwise requires, references to sections, clauses and appendices are references to sections and clauses of, and appendices to, the Network Terms;
- 4.1.3 Any reference in the Network Terms to a statute, statutory instrument, regulation or order will be construed as a reference to such statute, statutory instrument, regulation or order as amended or re-enacted from time to time;
- 4.1.4 Any references to a “party”, is to a party to the Determination (unless the context otherwise requires or unless specifically provided to the contrary) and will be deemed to include its successors and permitted assigns and includes any person who becomes an access provider subsequent to the Determination being made;
- 4.1.5 A reference to a “person” includes an individual, firm, company, corporation, unincorporated body of persons, state or government or agency thereof, and any other body or entity (in each case whether or not having separate legal personality);
- 4.1.6 Any reference in the Network Terms to any gender includes all genders and a reference to the singular includes the plural and vice versa;
- 4.1.7 If a period of time is specified and dates from a given day or the day of an act or event, it is to be calculated exclusive of that day; and
- 4.1.8 A reference to a day is to be interpreted as the period of time commencing at midnight and ending 24 hours later.

4.2 Definitions

In the Network Terms, unless the context requires otherwise:

Term	Definition
Audit Carrier	Means a Carrier whose compliance with the Equivalent Service criteria set out in the Network Terms is being audited by the Enforcement Agency.
Bilateral Agreement	Means an agreement between a Carrier who is obliged to comply with the Network Terms and another person, <u>(who might or might not also be a party to the Network Terms) relating in full or in part to Porting.</u>
Billing Relationship	Means a relationship where the Service Provider has a bona fide right to charge the Customer for any chargeable activity relating to the Local Services or Mobile Services provided to that Customer.
Business Day	Means a day on which registered banks are open for normal banking business, excluding Saturdays, Sundays and nationwide public holidays. Regional public holidays are considered to be Business Days.
Bypass Carrier	Has the meaning ascribed in clause 7.2.8.
Carrier	Means an entity that operates a public switched telephone network (or a functionally equivalent system) that originates, transmits or terminates voice calls or short messages. The same person may be both a Carrier and a Service Provider. If a party to the Network Terms has more than one Network, it can be classified as more than one Carrier.
CLI	Means Calling Line Identification.
Complex Dispute	Has the meaning ascribed in clause 16.2.1.
Contracted Service Deliverer or CSD	Has the meaning ascribed in clause 7.2.4.
<u>Costs Allocation Issue</u>	<u>Means any disagreement or dispute between the parties which relates to the quantification of industry common system costs or per-line set-up costs for the purpose of allocation in accordance with the Commerce Commission's determination in Decision No. 554.</u>
Customer	Means a person who has a bona fide Billing Relationship with a Service Provider in respect of a Local Service or Mobile Service.
Determination	Means the Commerce Commission's determination pursuant to Decision number [specify].
Donor Carrier	Has the meaning ascribed in clause 7.2.5.
Donor Carrier Re-routeing	Has the meaning ascribed in clause 9.1.1.
During Porting Fault	Has the meaning ascribed in clause 17.4.1.
Enforcement Agency	Means a person nominated by the TCF and approved by the Commerce Commission or, if the TCF fails to nominate a person, a person appointed by the Commerce Commission, whose role is to monitor and, if necessary, measure Equivalent Service compliance in accordance with clause 14.4.
Equivalent Service	Has the meaning ascribed in clause 14.1.
Event	Means an instance of one of the agreed set of processes that can arise from a specific Customer action, for which a specific Process exists.
Hand-off Code or HOC	Has the meaning ascribed in clause 13.1.
Gaining Carrier or GC	Means the Carrier that will become the Host Carrier, after the completion of a Port.

Deleted: '

Deleted: (who may also be obliged to comply with the Network Terms)

... [1]

Term	Definition
Host Carrier or HC	Has the meaning ascribed in clause 7.2.6.
Industry Portability Management System or IPMS	Means the <u>software, hardware and other facilities shared by the industry and used to give effect to</u> the LMNP Terms.
Initiator	Has the meaning ascribed in clause 16.2.2.
Local and Mobile Number Portability or LMNP	Means Local Number Portability and Mobile Number Portability.
LMNP Terms	Means the Terms for Local and Mobile Portability in New Zealand.
Local Calling Area	Means that geographic area defined by the Donor Carrier within which Customers <u>of the DNO</u> have access to a Local Service.
Local Number	Means an 8 digit number, in the form: area code + NXXXXXX where area code equals 3,4,6,7 or 9 and "N" equals digits 2 to 9 (excluding 50AB).
Local Number Portability or LNP	Means the local telephone number portability service, as defined in the Telecommunications Act.
Local Service	Means the service associated with a Local Number.
Losing Carrier	Means the Carrier that is the Host Carrier prior to the completion of the Port.
Mediation Period	Has the meaning ascribed in clause 16.2.4.
Mobile Number	Means a number in the form 02N + XXXXXXX where "N" equals 1,5,7 or 9 and other cellular numbers allocated by the NAD, or recognised by the NAD as having been allocated.
Mobile Number Portability or MNP	Means the cellular telephone number portability service, as defined in the Telecommunications Act,.
Mobile Service	Means the service associated with a Mobile Number.
Negotiation Period	Has the meaning ascribed in clause 16.2.3.
Network	Means a system comprising telecommunication links to permit telecommunications.
Network Routing Number or NRN	Has the meaning ascribed in clause 12.3.3.
Network Terms	Means these Network Terms for Local and Mobile Number Portability in New Zealand, including all Appendices hereto, as determined by the Commerce Commission.
Non-participating Carrier	Has the meaning ascribed in clause 7.2.7.
Non-voice Services	Means those services which are not Voice Services and in respect of which interconnection arrangements exist between the parties.
Number	Means a Local Number, a Mobile Number or both, as the case requires.
Numbering Administration Deed or NAD	Means the organisation established under the Numbering Administration Deed dated 20 December 1998, or any such successor organisation or agreement that may be formed.
Operational and Support Manual for LMNP	Means a multilateral agreement between Carriers that covers operational issues that are not dealt with by the Network Terms.
Originating Carrier	Has the meaning ascribed in clause 7.2.1.
Originating Carrier Re-routing	Has the meaning ascribed in clause 9.1.1.
Planned Outage	Has the meaning ascribed in clause 19.1.1.
Post Porting Fault	Has the meaning ascribed in clause 17.4.2.
Public Land Mobile Network Short Message Entity or PLMN SME	Means a mobile device connected to a mobile Network.

Deleted: system described in

Term	Definition
Port or Porting	Means a process which achieves or is intended to achieve LMNP.
Port Activation	Has the meaning ascribed in the LMNP Terms.
Port Request	Has the meaning ascribed in the LMNP Terms.
Ported Calls	Means those calls made in respect to establishing connections to Ported Numbers.
Ported Number	Means a Number that is currently hosted by any Carrier other than the Donor Carrier.
Service Levels	Means the requirements for Equivalent Service and the service levels as prescribed in Table 2 of the Appendix to the LMNP Terms.
Service Provider or SP	Means any person providing a Local Service or Mobile Service to a Customer who has the Billing Relationship with the Customer for that service. The same person may be both a Carrier and a Service Provider.
Short Message Originating Carrier	Has the meaning ascribed in clause 8.2.1 definition.
Short Message Service	Means the alphanumeric messaging mechanism between two PLMN SME.
Short Message Terminating Carrier	Has the meaning ascribed in clause 8.2.2.
Standard Tests	Means the tests set out in <u>the Operations and Support Manual for LMNP</u> .
TCF Management Committee	Means the TCF Board (as defined by the TCF Rules) or a subcommittee of the TCF Board as set out in clause 4.8 of the TCF Handbook plus either case a non-voting representative of the Telecommunications Commissioner.
Technical Dispute	Has the meaning ascribed in clause 16.2.2.
Transit Carrier	Has the meaning ascribed in clause 7.2.3.
Terminating Carrier	Has the meaning ascribed in clause 7.2.2.
Unplanned Outage	Means an outage in <u>the Carrier's Network that may affect LMNP</u> that is not a Planned Outage.
Voice Services	Means those voice services and associated features provided or initiated during call setup or call duration, for which interconnection arrangements exist between the parties.

Deleted: clause 17.2

Deleted: the IPMS or

5 Business Rules

5.1 Non-discrimination

In implementing and operating the Network Terms, all parties to the Network Terms must act in a competitively neutral and non-discriminatory manner and must facilitate Porting by acting in compliance with principles and processes that are consistent with section 18 of the Telecommunications Act.

5.2 Privacy and Use of Information

A Carrier or Service Provider which receives any type of information relating to the Porting of a Number may only use such information in accordance with the *Privacy Act 1993*, the Telecommunications Information Privacy Code 2003, and the Network Terms.

If there is any inconsistency between the Network Terms, the *Privacy Act 1993*, and the Telecommunications Information Privacy Code 2003, the *Privacy Act* and the Telecommunications Information Privacy Code prevail.

5.3 Good Faith

All parties will act co-operatively and in good faith in implementing the Network Terms.

5.4 Bilateral and other Agreements

5.4.1 All Carriers that are bound by the Network Terms must comply with the provisions of the Operational and Support Manual for LMNP, dealing with the operational issues not included in the Network Terms, which is to be agreed by the Carriers. The Operational and Support Manual for LMNP may include, amongst other things:

- a) Enhancements to the call handover arrangements;
- b) Fault handling procedures;
- c) Operational procedures such as forecasting, contact details, escalation procedures, support arrangements and testing plans;
- d) Implementation arrangements for Carriers who will be participating at cutover and for those who will join later;
- e) Migration arrangements for those Customers who have a Ported Number prior to 1 April 2007; and
- f) Other issues related to number portability,

provided that if the Operational and Support Manual for LMNP contains anything inconsistent with these Network Terms or the LMNP Terms, then, to the extent of the inconsistency, the Network Terms or the LMNP Terms, as the case may be, shall prevail and the Operational and Support Manual for LMNP shall be of no effect.

5.4.2 Carriers may enter into Bilateral Agreements for the provision of services and service information that is required to facilitate and support the origination, carriage, handover and termination of calls in an efficient and expeditious manner.

5.4.3 Carriers may enter into Bilateral Agreements for higher Service Levels for standards and practices than those set out in the Network Terms, in which case

Deleted: [

Deleted:]

the Bilateral Agreement will prevail over the Network Terms with respect to the relevant Service Level for standards and practices, to the extent of the inconsistency. In all other circumstances, if there is a conflict between the Network Terms and a Bilateral Agreement, ~~the Network Terms shall prevail over the Bilateral Agreement to the extent of the inconsistency.~~

Deleted: the order of precedence will be (1)

5.4.4 For the avoidance of doubt, Carriers may set out more detailed standards and practices in their Bilateral Agreements than are outlined in the Network Terms, provided that the more detailed standards and practices are consistent with, or provide for higher Service Levels than the standards and practices set out in the Network Terms.

6 Carrier Responsibilities

It will be the responsibility of each Carrier to ensure that it meets the required Service Levels. Each Carrier is free to determine how it handles calls, either within its own Network or with the assistance of another Carrier. Where the Network Terms refer to the responsibility of a Carrier, the responsibility under the Network Terms remains with the Carrier, regardless of whether the Carrier may have contracted with a third party for performance of the activity in question.

6.1 Carrier Rules

- 6.1.1 Each Carrier will make the necessary changes, additions or deletions to its Network to give effect to the instructions issued by the IPMS.
- 6.1.2 The routing of calls to or from Ported Numbers must comply with the Network Terms to ensure calls are correctly routed.
- 6.1.3 Parties will act in good faith to facilitate Porting in each particular instance of Porting.
- 6.1.4 The Network solution adopted by Carriers must be capable of satisfying the requirements for Equivalent Service.
- 6.1.5 Carriers are responsible for maintaining the integrity of their own Networks in relation to Porting and there is an obligation on Carriers to work together to maintain this integrity.

6.2 Compliance with Service Levels

Each party to the Network Terms must comply with the Service Levels, including the requirements for Equivalent Service (See clause 14).

6.3 Network Planning and Design

It is the responsibility of each Carrier to undertake reasonable forward network planning and design in order to reasonably cater for the expected Porting activity. Each Carrier may use its own standard procedures for the planning and design of their own Network to meet this requirement.

6.4 Network Performance

It is the responsibility of each Carrier to plan, design, and operate its porting solution in a way that will meet reasonable industry standards of network performance. Each Carrier is free to use its own standard procedures in the planning, design, and operation of its own Network to meet this requirement.

6.5 Non-Participating Carriers

To the extent that a Carrier:

- (a) offers calls from a Ported Number to a Non-participating Carrier, or
- (b) accepts calls to a Ported Number from a Non-participating Carrier,

Deleted:

Formatted: Bullets and Numbering

Deleted: , or accepts calls from,

it shall use reasonable endeavours to ensure that the general technical and performance issues as described above are reflected in any Bilateral Agreement between the Carrier and the Non-participating Carrier.

6.6 Emergency Voice Calls

It is the responsibility of each Carrier to ensure that voice calls originating in its Network to the 111 Emergency Service are not adversely affected by LMNP in accordance with clause 14.

Deleted: <#>[omitted]

7 Carrier Relationships and Network Model for Voice Services

7.1 Carrier Relationships for calls made to Ported Numbers

The Carrier relationships are shown in the following diagram:

Deleted: c

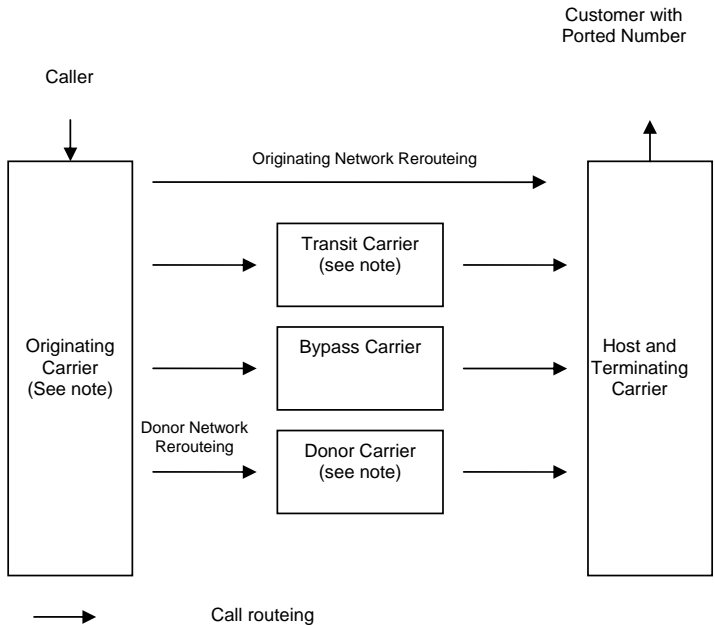

Note: Carrier may also provide Contracted Service Deliverer function
Various combinations of these relationships may occur.

7.2 Network Model

The following Carrier entities may exist in an environment where Numbers are Ported. Their relationships are shown in the diagram above. Note that any given Carrier may be a mix of more than one of the entities.

7.2.1 Originating Carrier

Means the Carrier on whose Network a voice call originates.

7.2.2 Terminating Carrier

Means the Carrier which terminates a voice call to a Customer connected to its Network.

7.2.3 Transit Carrier

Means a Carrier that transits a voice call on behalf of an Originating Carrier or a Bypass Carrier between that Originating Carrier or Bypass Carrier and the Host Carrier. In delivering the voice call, the Transit Carrier takes no action to determine whether or not the called Number is Ported, and on-routes the voice call on the basis of the received Number.

7.2.4 Contracted Service Deliverer

Means a Carrier that is contracted by another Carrier to provide a service that identifies whether a Number has been Ported, and if so, that Carrier identifies the Host Carrier of the Ported Number, and on-routes accordingly. When on-routing to a Number that is not Ported, that Carrier will on-route on the basis of the received Number.

Deleted: p

7.2.5 Donor Carrier

Means the Carrier that has been allocated the Number by the NAD, or recognised by the NAD as having been allocated.

7.2.6 Host Carrier

Means the Carrier on whose Network the Ported Number is connected.

7.2.7 Non-participating Carrier

Means a Carrier which is not participating in the Porting of Local Numbers or Mobile Numbers and which routes voice calls to Ported Numbers to the Donor Carrier or a Contracted Service Deliverer in accordance with a Bilateral Agreement with that person.

7.2.8 Bypass Carrier

Means a Carrier which provides a call bypass service for a Customer, normally for national, international and fixed-to-mobile voice calls.

7.3 Handover of Ported Voice Calls

7.3.1 The handover of Ported Calls takes place at a point of interconnection with other Carriers which is located on the trunk side of a Carrier's exchange. The interface will generally use non-proprietary technical standards. Interconnection arrangements will be set out in Bilateral Agreements between the relevant Carriers.

7.3.2 The information flows that relate to Porting across the point of interconnection shall:

- a) Comply with industry standards and practices outlined in the Network Terms;
- b) Comply with all requirements relating to Equivalent Service, including those for emergency service calls (see clause 6.6);
- c) Protect the confidentiality of communications in accordance with clause 5.2 and the confidentiality provisions of the relevant Bilateral Agreement; and
- d) Comply with requirements for non-code access and code access.

Deleted: ; and

Deleted: <#>Comply with the Number Administration Deed and Number Allocation Rules.¶

Formatted: Bullets and Numbering

8 Carrier Relationships and Network Model for Short Message Services

8.1 Carrier Relationships for Short Messages to Ported numbers

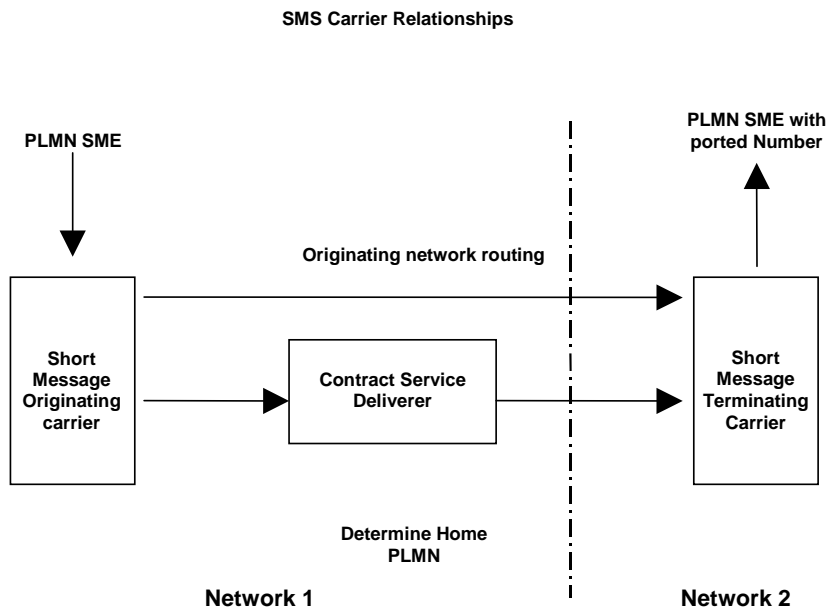

8.2 Network Model

The following Carrier entities may exist in an environment where Numbers are Ported. Their relationships are shown in the diagram above. Note that any given Carrier may combine the roles of more than one of the entities.

8.2.1 Short Message Originating Carrier

Means the Carrier on whose Network a short message originates.

8.2.2 Short Message Terminating Carrier

Means the Carrier which terminates a short message to a Customer connected to its Network.

8.3 Handover of Ported Short Messages

8.3.1 The handover of Ported short messages takes place at a point of interconnection with other Carriers which is located on the trunk side of a Carrier's exchange. The interface will generally use non-proprietary technical standards. Interconnection arrangements will be set out in Bilateral Agreements between the relevant Carriers.

8.3.2 The information flows that relate to Porting across the point of interconnection shall:

- a) Comply with industry standards and practices outlined in the Network Terms;
- b) Comply with all requirements relating to Equivalent Service; and
- c) Protect the confidentiality of communications in accordance with clause 5.2 and the confidentiality provisions of the relevant Bilateral Agreement, if any.

Deleted: ; and

Deleted: <#>Comply with the Number Administration Deed and Number Allocation Rules.¶

Formatted: Bullets and Numbering

9 Donor and Originating Carrier Re-routeing for Voice Services

9.1 Re-routeing Responsibilities

The Originating Carrier shall be responsible for routeing voice calls to Ported Numbers to the correct Host Carrier. A Contracted Service Deliverer may provide this service, should the Originating Carrier have such a contract with an appropriate Service Provider.

The necessary routeing and call handling arrangements will be provided for under Bilateral Agreements between Carriers.

9.1.1 By way of example, and subject to Bilateral Agreement, when routeing voice calls to a Ported Number, the Originating Carrier or Contracted Service Deliverer may:

- a) Route the voice call directly to the Host Carrier (assuming they have the capability to identify the Host Carrier of the Ported Number); or
- b) Route the voice call to the Donor Carrier who will identify the Host Carrier. The Donor Carrier may:
 - (i) Re-route the voice call to the Host Carrier; or
 - (ii) In the case where a query on release or redirection agreement exists with the Originating Carrier, may release the voice call with an appropriate signalling parameter indication.

For the purposes of the Network Terms, option a) and option b)(ii) above are termed Originating Carrier Re-routeing, and option b)(i) is termed Donor Carrier Re-routeing. Either of these options is available to the Originating Carrier or the Donor Carrier, or the Contracted Service Deliverer.

Deleted: is

9.2 Re-routeing Rules

9.2.1 A Carrier may wish to use a mixture of Originating Carrier Re-routeing and Donor Carrier Re-routeing, depending on their capability and their Bilateral Agreements with other Carriers.

9.2.2 A Non-participating Carrier will be required to enter a Bilateral Agreement with a Carrier to route voice calls to the Donor Carrier or the Host Carrier on their behalf.

9.2.3 Donor Carriers will ensure that they have the capability to re-route all voice calls to the correct Host Carrier on behalf of other Carriers with which they have a Bilateral Agreement for Donor Carrier Re-routeing for Ported Numbers in their Number ranges.

9.2.4 The query method used in a Carrier's Network is independent of the re-routeing method used by that Carrier.

9.3 Call Diagrams

Diagrams 1 to 5 below are voice call model charts that illustrate the generality of Donor Carrier Re-routeing, Originating Carrier Re-routeing, hybrid routeing (Originating and Donor Carrier Re-routeing), 2nd Port routeing; Bypass Carrier routeing; and Bypass Carrier routeing where they provide the Contracted Service Deliverer function. The following diagrams are intended to be illustrative, rather than exhaustive or prescriptive, and are not intended to limit the use of other routeing arrangements. However, the actual voice call outcomes, as shown in the diagrams, are to be complied with.

In particular, these charts show:

- the call handover point between Carriers (the “point of interconnection”)
- the subsequent routing of the voice call to the Ported Number Customer.

Diagram 1; Donor Carrier Re-Routing

(for the initial Port)

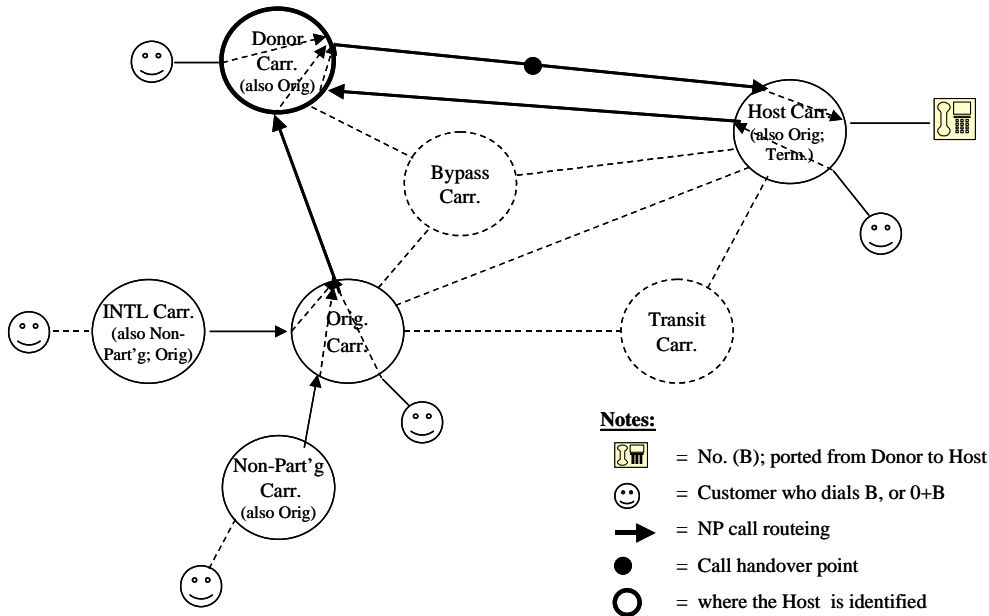

Diagram 2; Orig Carrier Re-Routing

(for the initial Port)

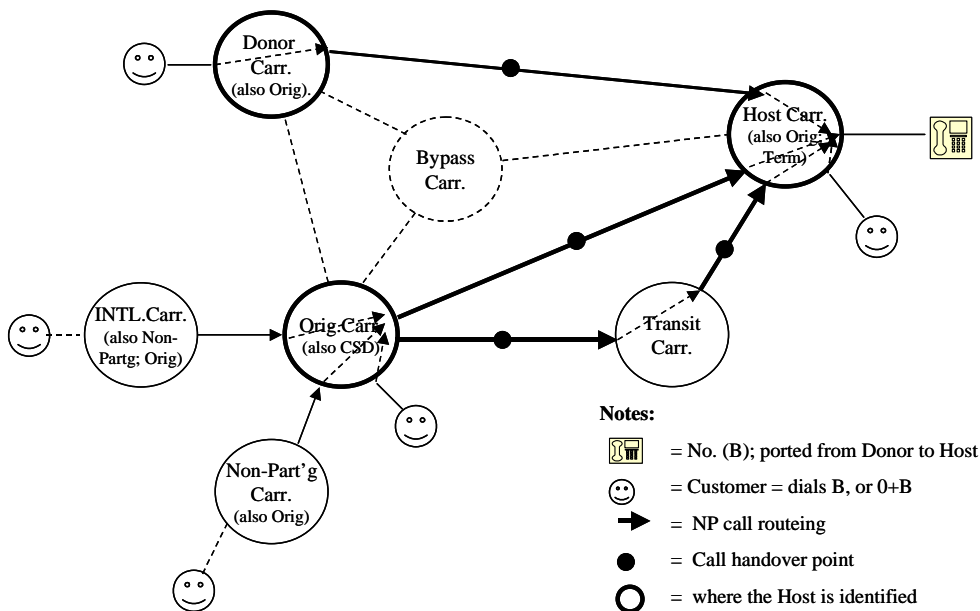

Diagram 3; Hybrid Donor/Orig Carrier Re-Routing

(for the initial Port)

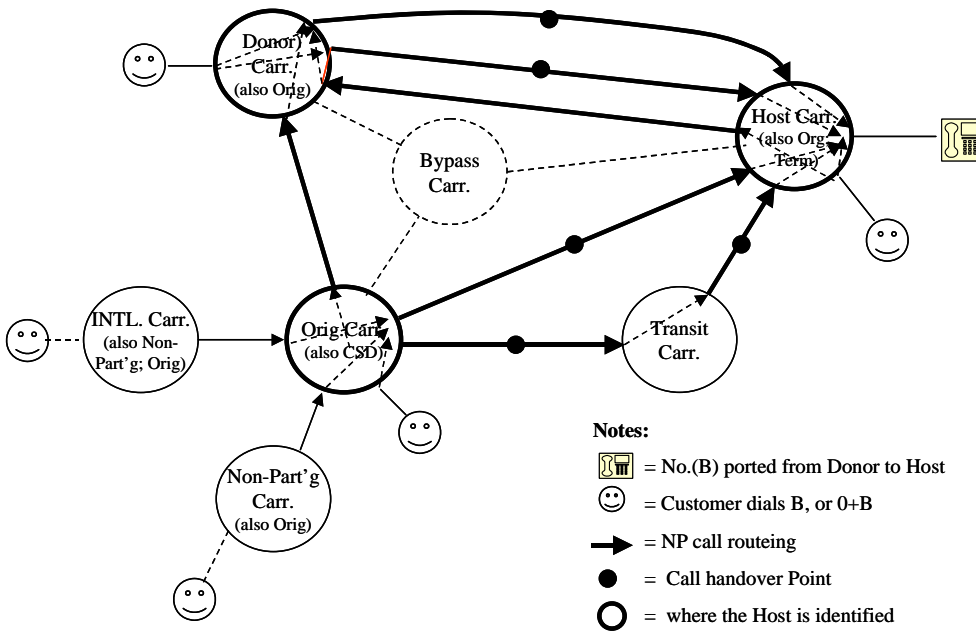

Diagram 4; 2nd Port Scenario (Hybrid Donor/Orig Carrier Re-Routing)

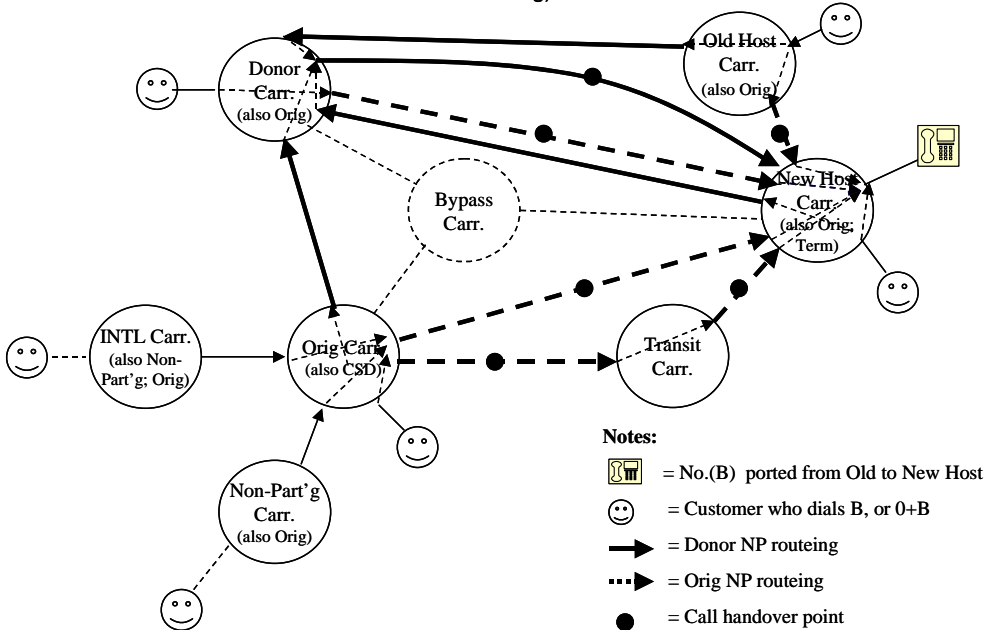
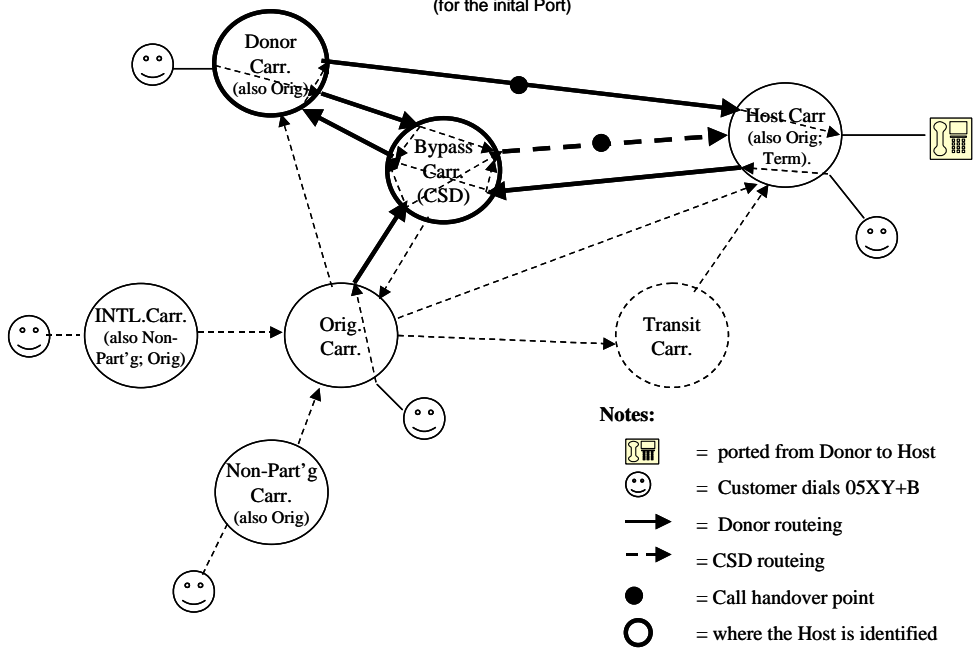

Diagram 5; Bypass Scenario (Donor or CSD Carrier Re-Routeing)
 (for the initial Port)



10 Voice Call Handling Rules

10.1 Voice Call Handling Solution

A Carrier that participates in LMNP must keep the following management information for each Number within its allocated blocks:

- a) Whether the Number is Ported; and
- b) The identity of the Host Carrier.

Originating Carriers have a responsibility to route voice calls to Ported Numbers to the Host Carrier. Non-Participating Carriers may utilise the Donor Carrier or a Contracted Service Deliverer to perform the routing in accordance with a Bilateral Agreement. In such cases, the determination of whether a Number is Ported or not (and any subsequent voice call routing), is undertaken by either the Donor Carrier or Contracted Service Deliverer.

The routing and handover of voice calls must be done in a way that prevents the misrouting (including circular routing) of voice calls to the greatest extent possible.

The following diagrams are intended to be illustrative, rather than exhaustive or prescriptive, and are not intended to limit the use of other routing arrangements. The actual voice call outcomes, as shown in the diagrams, are to be complied with.

Diagram 6

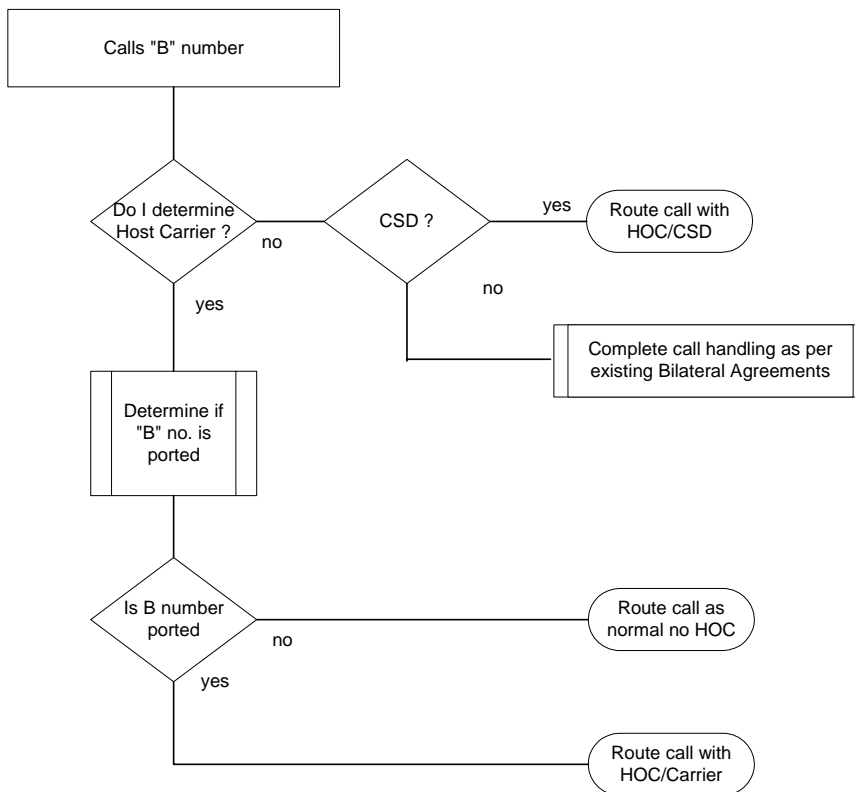

Diagram 7

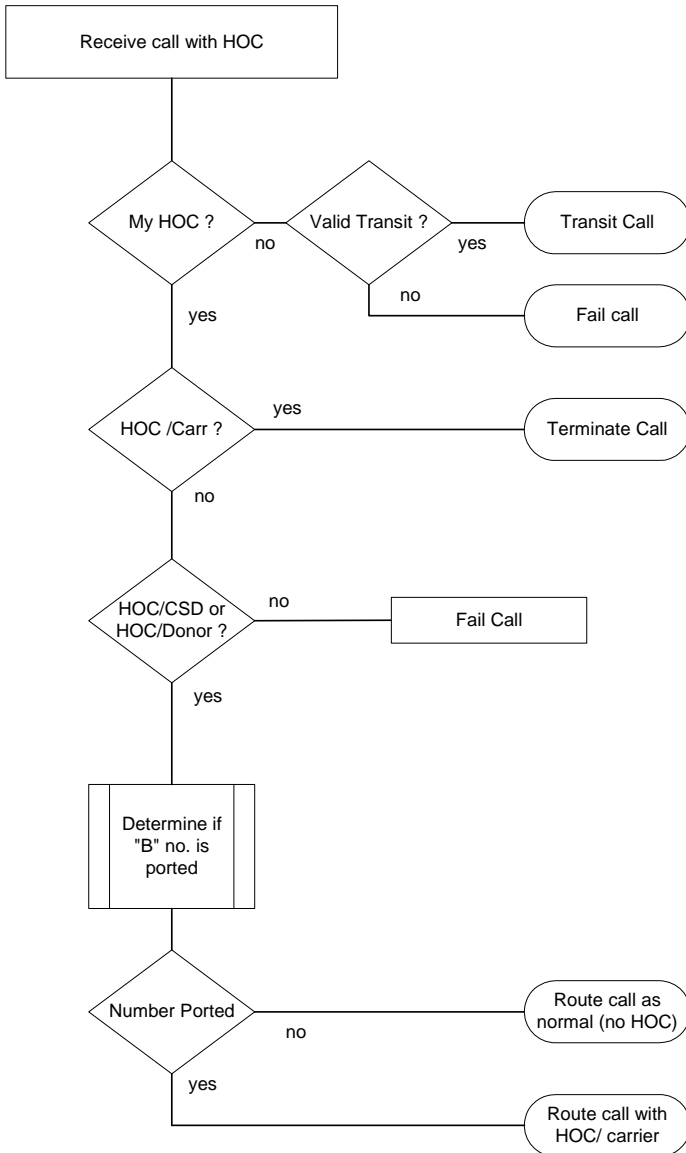
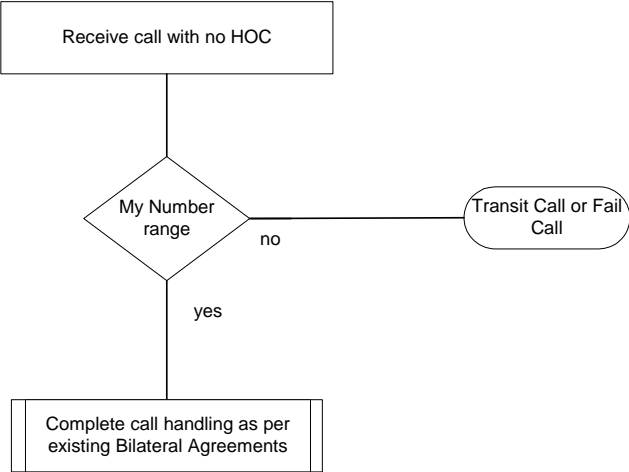

Diagram 8



11 Short Message Handling Rules

11.1 Short Message Handling Solution

A Carrier that participates in LMNP must keep the following management information for each Number within its allocated blocks:

- a) Whether the Number is Ported; and
- b) The identity of the Host Carrier.

Originating Carriers have a responsibility to route messages to Mobile Ported Numbers to the Host Carrier. Non-participating Carriers (e.g. International Carriers) may utilise either the Donor Carrier or a Contracted Service Deliverer to perform the routing in accordance with a Bilateral Agreement. A Short Message Service provider may also be a Contracted Service Deliverer. In such cases, the determination of whether a Number is Ported or not is undertaken either by the Donor Carrier or Contracted Service Deliverer. The routing and handover of messages must be done in a way that prevents the misrouting (including circular routing) of messages to the greatest extent possible.

The following diagrams are intended to be illustrative, rather than exhaustive or prescriptive, and are not intended to limit the use of other routing arrangements. The actual short message outcomes, as shown in the diagrams, are to be complied with.

Diagram 9

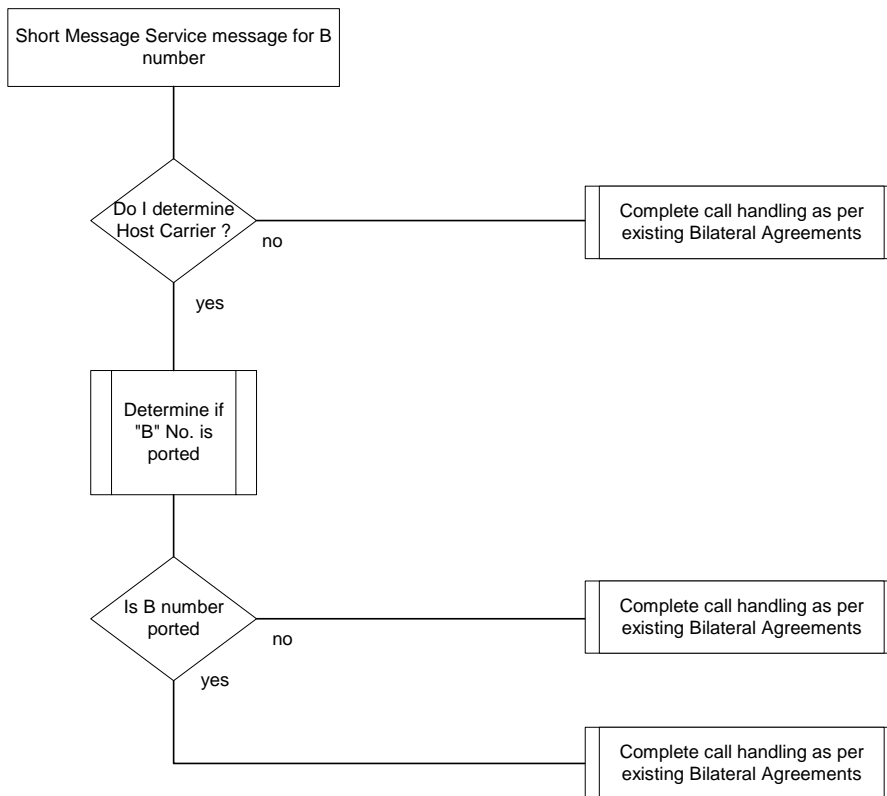
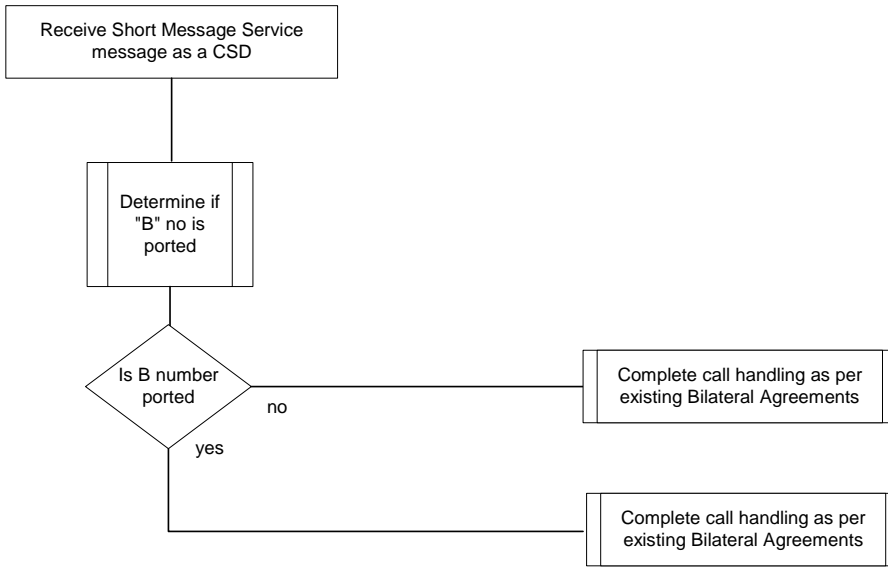

Diagram 10



12 Technical Call Handover and Signalling for Voice Services

12.1 General Inter-Network Signalling Standards

Inter-network call control signalling shall be in alignment with the relevant ITU/ETSI No.7 signalling standards.

12.2 General Signalling Capabilities

12.2.1 Delivering voice calls to Ported Numbers

In the context of the above standards, there are several alternative arrangements that can be used to determine the required routing information and to deliver voice calls to Ported Numbers. The Network Terms allow, without limitation, for the following alternative arrangements to be used, either alone or in combination, depending on the specific call scenario and according to Bilateral Agreement between participating Networks.

a) Originating Network Re-routing

In this scenario, the Originating Carrier determines the routing required to directly route the voice call to the Host Carrier (without routing to the Donor Carrier), and routes the voice call accordingly. Three alternative methods have been identified, without limitation, for achieving this. In each case the speech path established for the voice call does not traverse the donor Network, although methods (ii) and (iii) make use of information held in the donor Network in order to establish the voice call.

- (i) All Call Query (ACQ) Method
- (ii) Query On Release (QoR) Method
- (iii) Redirection Method

Each method shall comply with the Equivalent Service provisions.

b) Donor Network Re-routing

In this scenario, the Originating Carrier routes the voice call to the Donor Carrier.

On receiving the call, the Donor Carrier determines the required onward routing to the Host Carrier, and routes the call accordingly

c) Contracted Service Deliverer

By Bilateral Agreement, a Contracted Service Deliverer may perform the Originating Carrier's role of identifying the Host Carrier and the subsequent routing of voice calls to the Host Carrier.

12.2.2 Delivering voice calls from Ported Numbers

In general, voice calls originated from Ported Numbers in the Host Carrier's Network use identical signalling procedures to voice calls originated from non-Ported Numbers.

12.2.3 Other Inter-Network Signalling Standards

Some current interconnection agreements are based on the R2 MFC signalling standard. To the extent that this signalling standard does not support LMNP, Carriers using R2 MFC may be required to establish arrangements with other Carriers for the handling of voice calls to Ported Numbers.

Future network technologies and systems may offer alternative inter-network signalling standards that can support LMNP, and the Network Terms do not preclude these from being used in the future. In cases where such standards are used, the requirements of the Network Terms apply, [subject to any exemption in force pursuant to section 15 of these Network Terms or any clarification or reconsideration pursuant to Telecommunications Act ss 58 or 59.](#)

12.3 Definition of Signalling Terms

In general, capitalised terminology in this section aligns with ITU No. 7 signalling standards.

12.3.1 The Customer Number terminology used in this section is:

- **A:** the directory number of the Customer originating a voice call, generally known as the Calling-Party-Number.

In the context of Porting, **A** may be:

- the Number of a Customer calling a Ported Number; or
- the Number of the ported Customer when they originate a call.

- **B:** the directory number of the Customer to which a call is terminated, generally known as the Called-Party-Number.

In the context of Porting, **B** may be:

- the Number of a Customer being called by a Ported Number; or
- the Number of the ported Customer when a call terminates to them.

- **C:** a Number that can be used by a Host Carrier to terminate a call to a Ported Number in their Network. A **C** Number is usually a Number from the Number range associated with the Host Carrier's switch.

12.3.2 Number Format

The full form of the A, B, and C Numbers as used in the inter-network signalling (as distinct from the Numbers actually dialled by the calling Customer), are generally in the form of the ITU E.164 NSN, and under the NZ NAD numbering regime, are:

- Geographic Service Codes: Area Code+ Directory Number (eg; 99124200; 48019000; etc); and
- Non-geographic Service Codes: Service Code+Directory Number (eg; 219876543; 274567890; etc).

12.3.3 Network Routeing Numbers

To enable the correct inter-network and onward routeing of calls that terminate to a Ported Number, Carriers may need to use, or choose to use, a Network Routeing Number (**NRN**) in the signalling. This **NRN** is generally used as the Called-Party-Number as in clause 12.4 (1) below, although the exact structure and content of the **NRN** may vary between the two signalling standard alternatives. The possible structure and content options of an **NRN** are:

- **HOC+B**; or
- **HOC+C**; or
- **HOC** (may be relevant in the case of the Industry standard with enhancements - see clause 12.4 below), or
- **B** (if the Host Carrier agrees to this usage)

Where the **HOC** is a Hand-Off Code as described in clause 13.

For example; the **NRN** used for routeing a call to a Ported Local Number could have the contents of the Called-Party-Number as:

11934+99124200

12.4 Signalling for Calls to and from Ported Numbers

Contents of the Initial Address Message (IAM) Signalling Message

(1) Calling-Party-Number; Called Party Number; and the **NRN**

For calls delivered to a Host/Transit Carrier, terminating to Numbers ported to the Host Carrier:

Current Industry Standard (as per current Bilateral Agreements):

- Calling-Party-Number: = **A**
- Called-Party-Number: = **NRN** (e.g.; **HOC+B**) (or optionally, **HOC+C**); or **B**

Industry Standard with enhancements:

- Calling-Party-Number: = **A**
- Called-Party-Number: = **NRN** (e.g., **HOC**)
- Called-Directory-Number: = **B** (or optionally, **C**)

Note: these Industry Standard enhancements may also support other number portability signalling features such as:

- The provision of number portability call indicators; and
- QoR Cause-value information, indicating that a Number has been Ported

Deleted: LMNP

Deleted: LMNP

(2) CLI Information

For calls to and from Ported Numbers:

Calling Party CLI and CLIP/CLIR integrity is to be maintained – viz:

- Calling-Party-Number: = **A**
- CLIP/CLIR: = as set by the customer

13 Hand-Off Codes

Carriers may enter into Bilateral Agreements on the method of handing over calls between their Networks. The method may include the use of separate routes for calls to Ported Numbers and/or the use of HOC's. If HOC's are to be used, the provisions of this section will apply.

Deleted: agree bilaterally

13.1 HOC Allocation and Format

HOC's are codes used in Network and billing systems to identify certain characteristics of calls that are routed between Networks to Ported Numbers. HOC's are allocated to eligible Carriers according to rules specified by the NAD.

Details of HOC allocations can be found in the NAD Number Register (<http://www.nz.m-co.com>).

The HOC format is 011XNT where:

- a) X is currently digits 6 or 9 but may be any other digits allocated by the NAD;
- b) N identifies the Host Carrier Network;, and
- c) T identifies the service (LNP or MNP).

These codes are used in the format 011XNTnnn~nnn, where nnn~nnn is the dialled number in National Significant Number (NSN) format.

The proposed inter-network call handover arrangements in the Network Terms envisage new uses of these HOC's (e.g. to cater for requesting CSD functionality). Although the current NAD HOC regime can accommodate these requirements, the actual allocation of these new special HOC's will require them to be obtained from the NAD using the standard NAD allocation processes.

13.2 HOC Forwarding

The Host Carrier will be able to check inbound calls for the HOC and route accordingly. Calls that are determined by a Carrier to be calls to Ported Numbers are to have a HOC added by the Carrier and passed on to the Host Carrier (either directly or indirectly). If the Carrier has an agreement to pass all calls to the Donor Carrier, based on the Numbers allocated to them by the NAD, they may be forwarded with or without a HOC attached, subject to Bilateral Agreements.

In general, attaching a HOC to a call indicates that a Carrier has identified a call to a Ported Number and that the Carrier is aware of the correct Host Carrier. Note that the special use of HOC's as described in 13.3.2 is an exception to this.

13.3 HOC Trapping

In order to prevent the misrouting (including circular routing) of calls, which is possible if Carriers' records do not match each other, the following approach must be followed:

13.3.1 A Carrier may transit calls received with a HOC for a third-party Carrier, where this is covered by an agreement with the third party Carrier.

13.3.2 Carriers will not change or remove the HOC on a transit call. In the case of CSD or Donor HOC's, the Carrier undertaking the CSD (or Donor Re-route) function is

permitted to change the HOC (or to remove the HOC), as a result of the outcome of determining whether or not the Number is ported.

13.3.3 Carriers receiving a call with their HOC to a number that is not on their Network will fail the call.

13.3.4 A Carrier may add a HOC and forward calls that have been received without a HOC attached, if this is a service being provided to a Carrier under a Bilateral Agreement.

14 Equivalent Service

14.1 Definition

A service provided in relation to a Ported Number is an Equivalent Service, if (and only if) any differences in quality, reliability, services or features between it and a similar service provided in relation to a non-Ported Number:

- a) will not be apparent to a Customer; or
- b) if they are apparent to a Customer, will not affect the Customer's choice of Service Provider.

In accordance with this definition, Service Providers entering into agreement with Carriers must ensure that the technical solution deployed offers Customers with Ported Numbers Equivalent Service to Customers with non-Ported Numbers on the same Network.

In implementing the Network Terms and operating in accordance with them, all parties to the Network Terms are required to act in good faith to satisfy the requirements for Equivalent Service.

The criteria listed or referred to in clause 14.2 and 14.3 of the Network Terms are those that must be used by participating Carriers to assess whether a technical solution it deploys would constitute Equivalent Service in accordance with the definition above.

14.2 Equivalent Service Criteria for LMNP for Voice Services

The technical solution deployed by Carriers participating in LMNP in New Zealand shall provide an Equivalent Service for Voice Services in accordance with the following criteria:

14.2.1 Criterion 1 – Post Dialling Delay

There may be an increase in post dialling delay for a call to a Customer with a Ported Number compared to a similar call to a non-Ported Number. This may vary with the routing and call set up involved. The notion of a 'similar' call requires that comparisons should involve the same call types (for example, long distance, local, calls from mobile phones, and calls from the same origin exchange made at the same time to Ported and non-Ported Numbers at the same destination exchange).

The respective post dial delay Equivalent Service criteria for LNP and MNP scenarios are as follows:

LNP Equivalent Service	MNP Equivalent Service
Increase of not more than 1 second compared with a similar call to a Customer with a non-Ported Number in 99.9% of all call cases.	Increase of not more than 3 seconds in 98% of all call cases and not more than 5 seconds in 99.9% of all call cases compared with a similar call to a Customer with a non-Ported Number.

14.2.2 Criterion 2 – Call Failure

The rate of call failure because of congestion or malfunction for calls to Ported Numbers on either local or mobile Networks must be no greater than 1 in 100 calls higher than for calls to non-Ported Numbers.

14.2.3 Criterion 3 – Services and Features

The LMNP solution deployed by a Carrier must not prevent Customers with Ported Numbers from being offered the same services and features as those provided to Customers on that Carrier's Network with non-Ported Numbers.

This requirement applies to both incoming and outgoing Voice Services.

Deleted: its

Deleted: out

Deleted:

Deleted: call services and to non-call related features

14.3 Equivalent Service Criteria for LMNP for Non-Voice Services

The technical solution deployed by Carriers participating in LMNP in New Zealand shall provide an Equivalent Service for Non-Voice Services in accordance with the following criteria:

14.3.1 Criterion 1 – Services and Features

The LMNP solution deployed by a Carrier must not prevent Customers with Ported Numbers from being offered the same services and features as those provided to Customers on that Carrier's Network with non-Ported Numbers.

This requirement applies to both incoming and outgoing non-Voice Services.

Deleted: its

Deleted: out

Deleted: call services

14.4 Equivalent Service Compliance

Each Carrier must provide LMNP Equivalent Service, as defined in these Network Terms.

Each affected Carrier must provide a one-off certification that its Network complies with the Equivalent Service criteria based upon its design and implementation. The Enforcement Agency may require specific measurements to be undertaken by certain Carriers when the Enforcement Agency considers this is necessary as part of an investigation by it following a complaint. Where a systematic problem is identified, the Enforcement Agency may require regular network testing by the relevant Carrier or Carriers.

14.5 Enforcement Agency Audits

If the Enforcement Agency considers that it has reasonable grounds to do so, it may conduct audits of Carriers' documentation supporting compliance with the Equivalent Service criteria.

The detail of the Enforcement Agency audit powers and processes are to be set out in the Operational and Support Manual for LMNP.

Notwithstanding this, the cost of any audit will be allocated in accordance with the following principles:

14.5.1 If the audit report states that the Audit Carrier:

- (a) has complied with the Equivalent Service criteria set out in the Network Terms, then:
 - (i) if the audit was undertaken due to a request from another Carrier, then the Audit Costs will be payable to the Enforcement Agency by that other Carrier and, upon receipt of payment of that sum, the Enforcement Agency will reimburse the Audit Carrier its costs as set out below;
 - (ii) if the audit was undertaken otherwise than due to a request of a Carrier, each of the Enforcement Agency and the Audit Carrier will bear their own costs; or
- (b) has not complied with the Equivalent Service criteria set out in the Network Terms, then the Audit Costs will be payable by the Audit Carrier.

14.5.2 For the purposes of this section 14.5, "Audit Costs" means the aggregate of:

- (a) Enforcement Agency reasonable direct costs in respect of the audit (including auditing and legal fees); and
- (b) such costs of the Audit Carrier in respect of time involved in assisting the audit as are submitted by the Audit Carrier to the Enforcement Agency which the Enforcement Agency determines are fair and reasonable.

14.5.3 Failing an audit

- (a) If an Audit Carrier is determined by the Enforcement Agency to be in breach of the Equivalent Service criteria set out in the Network Terms, the Enforcement Agency may issue that Audit Carrier with a written:
 - (1) Caution Notice of Breach;
 - (2) Warning Notice of Breach; or
 - (3) Public Censure Notice.
- (b) The Enforcement Agency must consider the seriousness of the breach by the Audit Carrier, and the Audit Carrier's past conduct with respect to compliance with the Equivalent Service criteria, when making a determination whether to issue a Notice under clause 14.5.3. The Enforcement Agency must first have issued a Caution Notice of Breach and then a Warning Notice of Breach to the Audit Carrier in relation to the particular breach in question before making a determination to issue a Public Censure Notice relating to the Audit Carrier.
- (c) The Enforcement Agency will provide a copy of any Caution Notice of Breach, Warning Notice of Breach or Public Censure Notice issued to all parties to the Network Terms and, at the same time, to the Commerce Commission. Parties to the Network Terms who receive a copy of a Caution Notice of Breach or Warning Notice of Breach shall keep such notice confidential.

14.5.3.1 Caution Notice of Breach

- (a) The written Caution Notice of Breach to the Audit Carrier will include a request that one or more of the following actions be undertaken by the Audit Carrier:
 - i. rectification of the breach;
 - ii. specific corrective actions; and
 - iii. an internal review of the Audit Carrier's state of compliance with the Equivalent Service criteria.
- (b) The Caution Notice of Breach will specify a timetable within which the action is required to be completed, with duration dependent upon the nature and complexity of the action. The Enforcement Agency will also seek confirmation from the Audit Carrier of receipt of the Caution Notice of Breach.

14.5.3.2 Warning Notice of Breach

- (a) The written Warning Notice of Breach to the Audit Carrier is a more severe version of the Caution Notice of Breach, and may be appropriate for situations where the Audit Carrier has failed to undertake voluntarily the actions requested by the Caution Notice of Breach, within the timetable specified therein. The Warning Notice of Breach to the Audit Carrier will include an order that one or more of the following actions be undertaken by the Audit Carrier:

- i. rectification of the breach;
 - ii. specific corrective actions;
 - iii. arrange for an independent audit of its compliance procedures in relation to the Equivalent Service criteria to be conducted. The auditor must be approved by and report to the Enforcement Agency on compliance with the Equivalent Service Criteria. The Audit Carrier will be required to implement recommendations of the audit; and
 - iv. that the Audit Carrier conduct relevant education of its relevant staff to address knowledge inadequacies that may have led to the breach.
- (b) The Warning Notice of Breach will nominate a timetable within which the action is required to be completed, and the steps needed to be taken by the Audit Carrier to address the action required by the Warning Notice of Breach, with duration dependent upon the nature and complexity of the action. The Enforcement Agency will also seek confirmation from the Audit Carrier of receipt of the notice.

14.5.3.3 Public Censure Notice

- (a) In the event of a refusal or failure on the part of the Audit Carrier to undertake to the Enforcement Agency's satisfaction any actions required by a Warning Notice of Breach, within the timetable specified therein, the Audit Carrier will promptly be formally advised by the Enforcement Agency that a Public Censure Notice is to be prepared for widespread publication. The Audit Carrier will be sent an advance copy of the intended Public Censure Notice, which will:
- i. identify the Audit Carrier by name;
 - ii. give details of the breach;
 - iii. list all requests/orders previously made of the Audit Carrier;
 - iv. report on whether an independent audit has been ordered and, if so, state the results of the audit;
 - v. state that at the date of publication, the requests of the Caution Notice(s) of Breach and the orders of the Warning Notice(s) of Breach have not been complied with;
 - vi. specify a final timetable by which any corrective action must be completed by the Audit Carrier.
- (b) The Audit Carrier will also be advised that publication of the Public Censure Notice will not occur until a specified time period has elapsed from the date the advance copy of the public censure notice is sent, (the period of time is at the discretion of the Enforcement Agency). If the Enforcement Agency is fully satisfied that the Audit Carrier has fully complied as ordered prior to the date the Public Censure Notice is due to be published, then the Public Censure Notice shall not be published.
- (c) If the Public Censure Notice is proceeded with, it will be published in the New Zealand Gazette, the TCF's newsletter, and at the Enforcement Agency's discretion, in any relevant industry newsletter or magazine, in the national newspapers and in Consumer bulletins.

▼

14.5.4 Exemptions

The Audit Carrier may advise the Enforcement Agency of an exemption granted under clause 15, exempting the Audit Carrier from meeting some of its obligations under the Network Terms in respect of the Equivalent Service criteria. If the Enforcement Agency is satisfied that the exemption will prevent the Audit Carrier from carrying out any sanction imposed on it by the Enforcement Agency under the Network Terms within the timeframe provided for by the Enforcement Agency, the Enforcement Agency will have the discretion to suspend the sanction for so long as, and to the extent that, the exemption exempts compliance with the Equivalent Service criteria. The Enforcement Agency will notify all interested parties of any such decision.

Deleted: <#>[Omitted]¶

Formatted: Bullets and Numbering

14.5.5 For the avoidance of doubt, the procedures set out in clause 14.5 are additional to, and not exclusive of, any other rights a party may have under the Telecommunications Act, at law or in equity and nothing in clause 14.5.3 to 14.5.4 will prevent any party from exercising its right to enforce compliance with the Equivalent Service criteria in accordance with section 61 of the Telecommunications Act.

Formatted: Bullets and Numbering

Deleted: 5

15 Process for Exemption from Compliance with Obligations contained in the Network Terms

This process allows a Carrier to apply to the TCF Management Committee to recommend that the Commerce Commission grant an exemption from the obligation to comply with specific obligations under the Network Terms, for a specified period of time, and sets out procedures that the TCF Management Committee must follow in deciding whether or not to recommend an exemption.

15.1 Application to the TCF Management Committee for Exemption

15.1.1 A Carrier that expects not to be able, or considers it should not be required, to meet one or more of its obligations under the Network Terms until a later date may apply to the TCF Management Committee in writing requesting an exemption from the relevant Network Code obligations for a specified period.

15.1.2 The application must be made in writing to the TCF Management Committee and a copy must be sent to the Telecommunications Commissioner.

15.1.3 The application must state:

- a) The period for which the Carrier requests exemption;
- b) The obligations from which the Carrier requests exemption;
- c) The reasons (supported by documentary evidence, to the extent practicable) why the Carrier is unable, or should not be required, to meet its obligations during the specified period;
- d) The actions the Carrier has taken and proposes to take in order to meet the relevant obligations;
- e) The exchanges or geographic areas in respect of which the exemption is requested (if applicable);
- f) The date by which the Carrier will be able to meet its obligations, including a list of proposed key dates before that time;
- g) Whether and to what extent the requested exemption is likely to affect the Carrier's ability to comply with any of the LMNP Terms; ~~and~~
- h) Why the exemption sought would, if it were granted, best give or be likely to best give effect to the purpose set out in section 18 of the Telecommunications Act.

Deleted: and

Deleted: .

Formatted: Font: Bold

Formatted: Bullets and Numbering

15.2 TCF Management Committee to Notify Parties of Applications and Invite Submissions

Upon receiving an application for exemption, the TCF Management Committee must, within 5 Business Days, notify all parties to the Network Terms of the application and where they can obtain a copy of the application, and invite them to comment to the TCF Management Committee within 10 Business Days of being notified of the application.

15.3 TCF Management Committee may Recommend and the Commerce Commission may Grant Exemptions

15.3.1 The Commerce Commission may, by notice in writing, exempt a Carrier from the obligation to comply with one or more specified obligations under these Network

Terms, for a specified period, following receipt of a recommendation for exemption by the TCF Management Committee.

15.3.2 The TCF Management Committee may, by notice in writing to the Commerce Commission, recommend that the Commerce Commission grant a Carrier an exemption from the obligation to comply with one or more specified obligations under these Network Terms, for a specified period. All voting on whether to make such a recommendation will be governed by the rules of the TCF Board and set out in the TCF Rules and Handbook, and a unanimous vote (of those members present and voting) will be required for the recommendation of an exemption.

15.3.3 A recommendation by the TCF Management Committee to the Commerce Commission for an exemption under clause 15.3.1 shall specify: :

- (a) the period for which the exemption should have effect;
- (b) the obligations in respect of which the exemption should relate;
- (c) any purposes in relation to which the exemption should apply;
- (d) any Customer or class of Customers in relation to which the exemption should apply;
- (e) any conditions on which the exemption should be granted;
- (f) the consequences, if any, of an exemption in the terms proposed for compliance by the relevant Carrier with the LMNP Terms; ~~and~~
- (g) why the exemption sought would, if it were granted, best give or be likely to best give effect to the purpose set out in section 18 of the Telecommunications Act.

Deleted: and

Deleted: .

Formatted: Bullets and Numbering

15.4 Deciding an Application for Exemption

15.4.1 The TCF Management Committee shall use reasonable endeavours to decide whether to recommend granting an exemption within 40 Business Days of receiving the Carrier's request.

15.4.2 [omitted]

15.4.3 Before making a decision whether to recommend an exemption, the TCF Management Committee must, unless otherwise unanimously agreed by the members of the TCF Management Committee present and voting on the matter, and the applicant Carrier, consult with, and have regard to the opinion(s) of, at least one but no more than two independent expert(s). The independent expert(s) must be agreed to by the applicant Carrier and the TCF Management Committee (or, if agreement on an independent expert cannot be achieved within 10 Business Days of the TCF Management Committee receiving the application for relaxation, appointed by the president of the New Zealand Law Society or his/her nominee). The independent expert(s) may be internationally based, and between them must have experience and expertise in telecommunications and preferably also dispute resolution procedures.

15.4.4 The TCF Management Committee must also have regard to any submissions received from parties to the Network Terms within the timeframe set out in clause 15.2 above.

15.4.5 No independent expert will have any formal decision-making function.

15.4.6 The TCF Management Committee must not adopt inquisitorial processes.

15.4.7 Once the TCF Management Committee has reached an agreement on whether it will recommend that the Commerce Commission grant the exemption sought or not, it must inform the Commerce Commission in writing of its recommendation, setting out its reasons.

15.4.8 The Commerce Commission may grant an exemption only if it receives the TCF Management Committee's written recommendation to grant the exemption requested, and is satisfied that:

- a) It is not practicable for the applicant to meet its obligations under the Network Terms; and
- b) granting the exemption sought best gives, or is likely to best give, effect to the purpose set out in section 18 of the Telecommunications Act.

15.4.9 The Commerce Commission must give its reasons for granting or refusing to grant an exemption in writing and, if the exemption is granted, must:

- a) Specify the period for which the exemption shall have effect;
- b) Specify the obligations from which the Carrier is exempt;
- c) Specify any purpose in relation to which the exemption applies;
- d) Specify any Customer or class of Customers to which the exemption applies; and
- e) Specify any conditions on which the exemption is made; and

f) State why the Commission considers that granting the exemption best gives, or is likely to best give, effect to the purpose set out in section 18 of the Telecommunications Act.

Deleted: .

Formatted: Bullets and Numbering

For the avoidance of doubt, the TCF Management Committee may recommend any conditions or limitations it deems are appropriate in any exemption and the Commerce Commission may impose any conditions or limitations it considers appropriate on any exemption, whether recommended by the TCF Management Committee or not.

15.5 Compliance with the Network Terms after Applying for an Exemption

If a Carrier submits to the TCF Management Committee an application for an exemption, the Carrier must continue to comply with the requirements of the Network Terms until such time as the period specified in a notice of exemption issued by the Commerce Commission has commenced.

15.6 Notice of Decision about Exemption

15.6.1 The Commerce Commission must, as soon as practicable after making a decision on an application for exemption, cause to be published in the New Zealand Gazette, a notice stating:

- a) That it has made a decision on an application for an exemption; and
- b) How a copy of the text of the decision can be obtained.

15.7 Applications to the Commerce Commission for Exemptions

15.7.1 A Carrier that is a party to the Commerce Commission's Determination and expects not to be able, or considers it should not be required to meet some of its obligations under the Network Terms may choose not to submit an application for exemption to the TCF Management Committee, but instead apply to the

Commerce Commission for clarification or reconsideration of the Determination under:

- a) Section 58 of the Telecommunications Act; or
- b) Section 59 of the Telecommunications Act.

15.8 Right of Carrier to Apply to the Commerce Commission

15.8.1 If the TCF Management does not recommend exemption to the Commerce Commission, a Carrier that is a party to the Commerce Commission's Determination may apply to the Commerce Commission for clarification or reconsideration of the Determination, under sections 58 and 59 of the Telecommunications Act.

15.9 Confidentiality of Information

15.9.1 It is anticipated that parties to the Network Terms may choose to disclose confidential or commercially sensitive information in the course of preparing or commenting on a request for exemption that is submitted to the TCF Management Committee.

15.9.2 The parties to the Network Terms may request confidential treatment of commercially sensitive information provided to the TCF Management Committee or the Commerce Commission for the purpose of requesting an exemption.

15.10 Applicant Carrier to bear TCF Management Committee Costs

A Carrier that requests exemption in relation to these Network Terms shall bear all costs reasonably incurred by the TCF Management Committee due to the Carrier's request.

16 Administrative Issues

16.1 Clarification and Reconsideration of the Network Terms

The Network Terms are subject to Subpart 5 of Part 2 of the Telecommunications Act.

16.2 Dispute Resolution

16.2.1 Dispute

For the purposes of these dispute resolution procedures, a “dispute” is any Costs Allocation Issue or any matter relating to the Network Terms about which any of the parties to the Network Terms disagree or are unable to agree where a matter requires their agreement and which:

- (a) Is substantially a dispute of fact of a technical nature (**Technical Dispute**), including a service level default, but is not a Complex Dispute as defined in sub-clause (b); or
- (b) Is a dispute (**Complex Dispute**) that:
 - (i) May, in the opinion of a party to the dispute and the Network Terms have significant commercial implications for that party; or
 - (ii) Includes a substantial issue of fact of a non-technical nature or a substantial issue of law; or
 - (iii) is a Costs Allocation Issue.

If a dispute is not a Technical Dispute, then it is to be resolved as if it is a Complex Dispute. A Complex Dispute may include, without limitation, a dispute as to whether Local Number Portability or Mobile Number Portability is required to be provided in relation to a particular Local Service or Mobile Service.

16.2.2 Telecommunications Act 2001

No party to the Network Terms is prevented by these dispute resolution procedures from exercising any rights under the Telecommunications Act 2001, including but not limited to:

- (a) Applications for determinations, price reviews, clarifications, reconsiderations to the Commerce Commission under Part 2 of the Telecommunications Act;
- (b) Appeals against Commerce Commission determinations and proceedings for enforcement of Commerce Commission determinations to the High Court under subpart 5 of Part 2 of the Telecommunications Act; and
- (c) Investigations by the Commission under subpart 6 of Part 2 and Schedule 3 of the Telecommunications Act.

If there is a dispute about the extent of a party’s rights under the Telecommunications Act, then that dispute may be resolved in accordance with the procedures in the Telecommunications Act and these dispute resolution procedures will not apply to such a dispute.

If a dispute has not been resolved by the end of the Negotiation Period as defined below (and, if applicable, the Mediation Period as defined below), a party to the dispute may choose to resolve the dispute by pursuing any applicable rights under the Telecommunications Act or, in the alternative, by submitting a Technical Dispute for expert determination under clause 16.2.5 or by submitting a Complex Dispute for arbitration under clause 16.2.6.

Once a party (the “**Initiator**”):

- (a) has commenced a process under the Telecommunications Act; or
- (b) has submitted a dispute for expert determination or arbitration,

then, subject to clause 16.2.7 below, the Initiator cannot commence an alternative process, unless the process that has been commenced is held by the decision maker of that process not to apply to the resolution of the dispute in question.

Deleted: it

If the Initiator submits a dispute for expert determination or arbitration, that will not preclude the other parties to the dispute from pursuing any rights they may have under the Telecommunications Act.

16.2.3 Good Faith Negotiation

Any party to the Network Terms may at any time give notice describing a dispute to any other party (or parties) to the Network Terms who are involved in the dispute (Relevant Party). The party who gave notice of the dispute and the Relevant Parties are together referred to as the "parties to the dispute".

Deleted: r

Deleted: p

Deleted: r

Deleted: p

If a party gives notice of a dispute, then during a period of 10 Business Days from the date notice of the dispute was given (**Negotiation Period**), the authorised representatives of the parties to the dispute must attempt in good faith to negotiate a resolution of the dispute.

If the authorised representatives are unable to resolve the dispute within the 10 Business Day Negotiation Period, the parties to the dispute may agree to each refer the dispute to their respective Chief Executive (or equivalent officer or his or her nominee), in the case of a Complex Dispute, or operational manager, in the case of a Technical Dispute, who must attempt in good faith to resolve the dispute within a further 10 Business Days. If the parties agree to this further negotiation period, then for the purposes of the final paragraph of this clause 16.2.3, and for clauses 16.2.2, 16.2.4, 16.2.5 and 16.2.6 the "Negotiation Period" includes this further 10 Business Day period.

Deleted: Managing Directors

Deleted: s

Deleted: s

Deleted: s

If by the end of the Negotiation Period the parties to the dispute are unable to agree whether the dispute is a Technical Dispute or a Complex Dispute then, for the purpose of these dispute resolution procedures, the dispute shall be regarded as a Complex Dispute, and subject to clause 16.2.2 resolved under these dispute resolution procedures as such.

16.2.4 Mediation

At any time during the Negotiation Period, the parties to a dispute may agree to refer the dispute to mediation. The mediator will be appointed by agreement between the parties to the dispute, but failing agreement within 5 Business Days of the parties agreeing to refer the dispute to mediation, will be selected by the Chairperson of LEADR (Lawyers Engaged in Alternative Dispute Resolution) New Zealand Inc (or his or her nominee). Unless otherwise agreed in writing, the then current model mediation agreement issued by LEADR New Zealand Inc must be used and the mediation must be completed within 20 Business Days of the mediator's appointment (**Mediation Period**). The costs of the mediator will be paid by the parties to the dispute equally.

16.2.5 Determination of Technical Disputes by an Independent Expert

If a Technical Dispute has not been resolved by the end of the Negotiation Period (and, if applicable, the Mediation Period), a party to the dispute may give written notice to the relevant parties requiring the dispute to be determined by an independent expert.

The independent expert will be appointed by agreement between the parties to the dispute, but failing agreement within 5 Business Days from the date the notice was given under this clause, will at the request of the Initiator be nominated by the Chairperson of

Deleted: appointed at the request of the Initiator

the Board of the Telecommunications Carriers' Forum and approved by the Commerce Commission.

To be eligible for appointment, the expert must be independent and impartial, and must be experienced in telecommunications and will preferably be experienced in dispute resolution procedures. He or she must not have performed any duties, whether as an employee, consultant or contractor, for any of the parties to the dispute or any related party during a 12-month period prior to the date the notice of the dispute was given.

The expert will act as an independent expert and not as an arbitrator. The dispute will be resolved as soon as possible in accordance with the procedure determined by the expert, but in accordance with the principles of natural justice. Where the independent expert has primarily technical qualifications, he or she may seek independent legal advice regarding the appropriate procedures for resolution of the dispute.

The parties to the dispute agree to be bound by the decision of the independent expert, in the absence of manifest error. The costs of the independent expert (including the costs of any independent legal advice sought by the expert in accordance with these dispute resolution procedures) will be shared equally by the parties to the dispute. Reference to the independent expert will not be a submission to arbitration for the purposes of the Arbitration Act 1996 and that Act will not apply to or govern resolution of the dispute.

16.2.6 Arbitration of Complex Disputes

If a Complex Dispute has not been resolved by the end of the Negotiation Period (and, if applicable, the Mediation Period), a party to the dispute may then give notice referring any part of the dispute to arbitration. The notice will, subject to clause 16.2.2, be a submission by the parties to the dispute of the dispute to arbitration and each party to the dispute agrees to confirm this submission if requested by any other party to the dispute. Unless otherwise agreed in writing:

- (a) The arbitration will be subject to the Arbitration Act 1996 and its Schedules;
- (b) The parties to the dispute will endeavour to appoint a single arbitrator within 10 Business Days of notice being given;
- (c) The arbitrator must have experience and expertise in telecommunications and competition issues;
- (d) If the parties to the dispute fail to agree on a single arbitrator within the 10 Business Day period, then the President of the New Zealand Law Society (or his or her nominee) shall appoint the arbitrator at the request of any of the parties to the dispute;
- (e) The arbitrator must adopt a procedure which, in the arbitrator's opinion, is expeditious. If feasible in the circumstances the arbitrator will endeavour to complete the arbitration within 2 months of the arbitrator's appointment (or such lesser period as is appropriate);
- (f) The arbitrator may determine the dispute without a hearing unless any party gives notice requiring one, in which case the arbitrator must treat that as a material consideration in assessing costs;
- (g) The arbitrator must not adopt inquisitorial processes;
- (h) The arbitration must take place in Wellington or Auckland (at the arbitrator's discretion);
- (i) The arbitrator must determine the dispute under New Zealand law;
- (j) Any party may appeal to the High Court on any question of law arising from an award; and

Deleted: then, subject to clause 16.2.2,

Deleted: ,

- (k) The arbitrator may commission assistance or any reports from any expert or other person which, in his or her opinion, would assist him or her in making the award. The cost of this assistance or report is:
- (i) To be a cost of the arbitration; and
 - (ii) Unless the arbitrator orders otherwise, to be shared equally between the parties to the dispute.

The arbitrator must:

- (iii) provide copies of any assistance or report to the parties to the dispute;
- (iv) allow each party to make submissions in response to that assistance or report;
- (v) allow each party to produce evidence on any issue raised in that assistance or report; and
- (vi) allow each party to make submissions in response to any evidence produced by any party.

16.2.7 Court Proceedings

Notwithstanding the above dispute resolution procedures, a party to the Network Terms may at any time commence court proceedings relating to any dispute if that party seeks urgent interlocutory or interim relief. Otherwise, and except where a party to the dispute chooses to pursue any rights it may have under the Telecommunications Act as contemplated by clause 16.2.2, the dispute resolution procedures in the Network Terms are mandatory and parties to the Network Terms contemplate that they will not resort to court proceedings. If court proceedings other than proceedings contemplated by clause 16.2.2 are commenced, a relevant party shall be entitled to seek a stay of court proceedings in favour of an appropriate dispute resolution procedure under the Network Terms. All the provisions in this clause 16.2 as to dispute resolution shall apply, irrespective of whether any party to the determination of which they form part has filed the determination in the High Court as provided for in section 61 of the Telecommunications Act.

16.2.8 Continuance of Obligations

Except where the dispute renders it impossible to do so, the parties to the dispute must continue performing their respective obligations under the Network Terms while the dispute is being resolved or is subject to expert determination, arbitration or court proceedings, or a party is pursuing its rights under the Telecommunications Act. Each party to the Network Terms must use all reasonable endeavours to ensure that where a dispute is reasonably foreseeable, it is dealt with at a sufficiently early stage to ensure that there is a minimum effect on the ability of any party to perform its obligations under the Network Terms.

16.2.9 Use or Disclosure of Information

No party to a dispute may use, other than to attempt to resolve the dispute, any information disclosed by any other party to the dispute in the course of negotiation, expert determination, mediation or arbitration under the dispute resolution procedures. Any such information remains the property of the party supplying it and remains confidential to that party. Disclosure in the course of negotiation, expert determination, mediation or arbitration under the above procedures shall not constitute a waiver of confidentiality.

Neither party may disclose any such information to anyone other than an adviser or independent witness who has entered into a deed undertaking:

- (a) not to disclose any of the information, or any analysis of the information, other than to the parties to the dispute, an independent expert, a mediator, an arbitrator or court, except as compelled by law; and
- (b) to return all material on which such information is recorded on completion of the adviser's or independent witness's services.

16.2.10 Bilateral Agreements

The dispute resolution procedures set out in this clause 16.2 apply to the extent they are not inconsistent with the dispute resolution procedures in a Bilateral Agreement that incorporates the Network Terms in full or in part for a dispute under the Bilateral Agreement relating to the subject matter of the Network Terms.

17 Fault handling and testing procedures

The purpose of this section 17 is to provide processes and requirements for the management and resolution of [Network faults](#) involving LMNP. [These fault handling and testing procedures do not relate to the IPMS.](#)

The primary responsibility for handling and resolving Customer fault enquiries lies with the Service Provider of that [Customer service](#). The Service Provider shall work with the Carrier providing Network services to resolve the fault. It is anticipated that the necessary business process relating to fault handling in general between Service Providers and their Carriers will already exist.

Deleted: c

The specific inter-carrier process for LMNP fault handling and resolution should be developed by participating Carriers by way of amendments to existing Bilateral Agreements regarding fault handling.

Access to, and use of, the information in the IPMS databases shall be restricted to those required for operational purposes, such as for routing of calls and fault handling. Carriers shall not make use of the information obtained from these databases for any other purposes.

Each Carrier will progress its own fault handling within its own Network. Procedures for joint investigation or the co-ordination of fault handling, as agreed between the Carriers, shall be used, as for any other co-ordinated interconnect faults.

Each Carrier, together with the relevant Service Provider is responsible for its own Customer base and as such will have control of any service fault reports. Fault handling for the Ported Numbers is to be under the control of the Gaining/Host Carrier, although additional co-ordination may be required with the Losing/Donor Carrier. The Gaining/Host Carrier will work closely with the Losing/Donor Carrier and the other Carriers to resolve any fault reports, as for any other interconnect faults.

17.1 LMNP [Network](#) Fault Management Procedures

The following general procedures shall be implemented for the resolution of LMNP [Network](#) faults:

- a. The Gaining Carrier or Host Carrier, as the case may be, is to manage the investigation of faults reported on Ported Numbers during and after Porting.
- b. If a customer with a Ported Number reports a fault relating to their service to a Carrier other than the Gaining Carrier or Host Carrier for that service, then that Carrier must advise the Customer to contact its Gaining Carrier or Host Carrier to report the fault.

- c. If a Customer calling a Ported Number reports a fault to their Carrier, then that Carrier must investigate and resolve the fault as per their normal fault management procedures.

17.2 Standard Testing

Standard Tests will be conducted in accordance with procedures set out in the Operations and Support Manual for LMNP, before reporting a fault to another Carrier.

Each Carrier while diagnosing a fault must use sufficient analysis to identify which Carrier's Network may be causing the fault and then direct the fault report to the identified Carrier in the first instance.

17.3 Additional Tests for Complex Ports

In the case of a Complex Port, the Gaining Carrier or Host Carrier must conduct the Standard Tests, however the Gaining Carrier or Host Carrier does not need to test all Numbers if there are more than ten (10) Numbers associated with a service which are in a sequential number range.

17.4 LMNP Network Fault Reporting

Network faults will be reported in accordance with the Operations and Support Manual for LMNP.

18 Capacity forecasting procedures

The purpose of this section 18 is to assist LMNP participants to build and provision adequate capacity on their Network.

Each Carrier shall be required to provide each other Carrier participating in LMNP with forecast volumes of Ported Calls for agreed periods at agreed times. Forecasts are provided by the Carrier in the context of reasonable endeavours, and in good faith, and no Carrier is liable to any other Carrier, as a result of the accuracy or content of any forecast.

Carriers shall liaise as required, in order to resolve any issue as to the understanding or accuracy of any forecast. In particular if a Carrier becomes aware, during a period for which a forecast has been provided, of any material change to that forecast, (whether transient, or ongoing), it must promptly give any other affected Carrier notice of the change.

19 Support arrangements and escalation procedures

The purpose of this section 19 is to provide the details for processes to allow for:

- management of Planned Outages
- management of Unplanned Outages
- escalation procedures
- disaster recovery

when these events are relevant to the management of Networks involved in LMNP. Unless specified otherwise, the procedures do not relate to the IPMS.

19.1 Management of Outages

Deleted: B

Deleted: , the Gaining Carrier or Host Carrier must verify that the:

Deleted: <#>Activation time for Porting has expired;¶
<#>Customer equipment is correctly terminated;¶
<#>Dial tone or an outgoing call capability is available on the Gaining Carrier or Host Carrier's Network;¶
<#>Test calls from within the Gaining Carrier or Host Carrier's Network are successful; and ¶
<#>Test calls from other Carriers Network are unsuccessful (collectively, the **Standard Tests**).¶

Formatted: Heading 3, Plain Heading, Third Level, Underrubrik2, Indent: Left: 0 pt, First line: 0 pt, Tabs: Not at 27 pt

Deleted: <#>During Porting Fault¶

¶
Each participating Carrier must maintain a nominated contact point (or points) at its Fault Reporting Centre that must be used by participating Carriers for the direct reporting of faults occurring during Porting ("During Porting Fault").¶

¶
<#>Post Porting Fault¶

¶
Post Porting Faults are faults occurring after Porting, and are to be reported using existing fault reporting methods ('Post Porting Fault').¶

¶
<#>Fault Clearance During Porting, or Immediately Post Porting¶

¶
If the Gaining Carrier or Host Carrier becomes aware of such a fault, the Gaining Carrier or Host Carrier may call the Losing Carrier or Donor Carrier's contact point(s) to report the fault after the Gaining Carrier or Host Carrier has completed the Standard Tests¶

¶
If the Losing Carrier or Donor Carrier receives a call from the Gaining Carrier or Host Carrier it should check the status and validity of the Port Request associated with the fault identified by the Gaining Carrier or Host Carrier. If the Port Request is invalid or the Port Activation is not yet closed then the fault report can be held, pending resolution of the state of the Port.¶

¶

... [2]

19.1.1 Planned Outages

Every effort must be made to ensure that Planned Outages that may affect LMNP do occur between 1am and 3am.

In the event that a Carrier identifies that they require an outage in the Carrier's Network that may affect LMNP, that Carrier must advise all involved parties via phone call and email at least 5 Business Days before the outage occurs (**Planned Outage**).

Deleted: IPMS or that

If there is any change to the Planned Outage date or time the change must be advised to all parties via phone call and email as soon as possible.

Carriers must provide details of all Planned Outages (including any change to those Planned Outages) to the TCF and the TCF must ensure those details are provided on the TCF website and updated when there is any change.

Deleted: D

Deleted: will be

19.1.2 Unplanned Outages

In the event that a Carrier identifies that it is experiencing an Unplanned Outage, it must as soon as practicable:

- (a) notify all parties involved in LMNP via phone call and email. The back up method is fax notification to those parties; and
- (b) confirm receipt of notification from each party.

Deleted: involved

The following information must be included in notification:

- (a) Nature of problem;
- (b) Location of problem
- (c) Impact of problem
- (d) Estimated time of resolution.
- (e) Next update time

The Carrier that had the Network outage must give notice of the conclusion of the outage to all parties via phone call and email or fax (as a back up) as soon as practicable. To the extent that parties may have ceased processing Porting transactions during an Unplanned Outage, they must recommence processing those transactions as soon as practicable after the Network fault has been rectified.

Deleted: p

Deleted: can initiate queued porting transactions once confirmation is advised by the IPMS management that those transactions can be completed

Each Carrier must provide the TCF with contact details for appropriate personnel in relation to Planned Outages and Unplanned Outages and the TCF shall maintain a contact list for each of the parties on the TCF's website.

Deleted: T

19.2 Escalation procedures

19.2.1 Procedure

If a fault is specific to LMNP traffic and does not affect other traffic types and if Bilateral Agreements do not provide specific arrangements for escalation procedures in the context of Network issues relating to LMNP, then parties shall use the following procedure:

- (a) In a LMNP environment, the Service Provider that owns the relationship with the Customer who originates the fault call is also responsible for coordination and escalation of the fault resolution process.

Formatted: Heading 3 form, Justified, Indent: Left: 36 pt, Outline numbered + Level: 3 + Numbering Style: 1, 2, 3, ... + Start at: 1 + Alignment: Left + Aligned at: 17.85 pt + Tab after: 53.85 pt + Indent at: 53.85 pt, Tabs: 90 pt, List tab + Not at 53.85 pt

- (b) The escalation procedure is to be used as a means of bringing unresolved issues to the attention of Carriers at all levels responsible for, or having authority to, expedite corrective action. To that end all LMNP participants must ensure that they nominate relevant contact points for the escalation of Porting issues.
- (c) In the case that any Porting activity is not resolved within the specified time frame or is resolved unsatisfactorily, any LMNP participant may escalate this matter to the next escalation point nominated by the other party. Unless otherwise specified, that escalation point will have the relevant amount of time to investigate, resolve and respond as specified for that point of escalation.
- (d) The escalation procedure is to be initiated when an issue that requires resolution has been reported to an LMNP participant for remedial or corrective action, and after a given period, either:
 - no response had been provided in relation to the issue raised; or
 - the issue raised has not been resolved; or
 - an unsatisfactory reason is given for the delay in remedial/corrective action to resolve the issue raised.
- (e) Prior to initiating the escalation procedure, the affected LMNP participant should conduct preliminary enquires within their own organisation in an attempt to resolve any issues raised. At this point, the relevant party should identify if the issue is the result of a known problem. Where it is identified that the problem is associated with an existing unresolved problem (and all other conditions have been met) then the affected LMNP participant can raise an escalation.
- (f) Once the above steps have been undertaken, the relevant party should initiate the escalation procedure as follows:
 - Advise the nominated escalation contact point.
 - If the issue cannot be resolved at the first level, advise that Carrier's or Service Provider's second level escalation of the affected parties for resolution.

19.2.2 Contact details for faults escalation procedure

At each level, the relevant escalation contact points must:

- supply adequate facilities for contact and commit to maintenance of that contact and when necessary provide an alternate point of contact; and
- acknowledge receipt of information provided by the other escalation contact point as soon as possible.

Each Carrier must provide the TCF with contact details for appropriate personnel in relation to faults escalation. The TCF shall maintain a list of escalation contacts for each of the parties on the TCF's website.

The levels of escalation and standard timeframes to escalate to the next level are:

Formatted: English (New Zealand)

Formatted: Heading 3 form, Justified, Indent: Left: 36 pt, Outline numbered + Level: 3 + Numbering Style: 1, 2, 3, ... + Start at: 1 + Alignment: Left + Aligned at: 17.85 pt + Tab after: 53.85 pt + Indent at: 53.85 pt, Tabs: 90 pt, List tab + Not at 53.85 pt

Formatted: English (New Zealand)

Escalation level	Description	Standard timeframe for contacting next escalation level
• Business As Usual	Represents the handover point for initial fault investigation and repair.	
• Level One	Escalation level where service level agreements are assessed as being “in danger of” being compromised or are not met	2 hours
• Level Two	Escalation level where service level agreements are impacted and Level One escalation has not affected a satisfactory resolution. Also may be invoked where multiple customers’ services are affected by the same problem.	4 hours
• Level Three	Level Two escalation has not affected a satisfactory resolution. Serious process or infrastructure integrity failure.	8 hours

19.3 Disaster Recovery

In the event a major **Network** fault occurs, there should not be a “bypass” of any escalation level but the standard timeframes can be shortened as the initiator request. The ultimate remedy to resolve an urgent fault will be a conference call between appropriate representatives and technical experts.

20 New entrant procedures

The purpose of this section 20 is to provide details and information for new entrants.

20.1 Contracted Service Deliverer

A Contracted Service Deliverer can perform **Number portability** database lookups on behalf of other Network operators. The Contracted Service Deliverer may also provide interconnection services to other Donor Carriers or Host Carriers, (ie, also has a Transit Carrier role) and, if so, the requirements of a Transit Carrier or Bypass Carrier may also be applicable. A Contracted Service Deliverer must:

- (a) be familiar **with**, and **comply with**, the obligations required under the LMNP Terms and Network Terms;
- (b) be familiar with the call handling procedures laid down in the Network Terms;
- (c) complete a connection to the IPMS and all relevant commissioning testing;

- Deleted: LMNP
- Deleted: They
- Deleted: have complied
- Formatted: Bullets and Numbering
- Formatted: Indent: Left: 18 pt
- Formatted: Bullets and Numbering
- Formatted: Indent: Left: 18 pt
- Formatted: Bullets and Numbering

(d) ensure that the Ported Number Register is updated with current data; and

(e) provide contact details for support and escalation purposes to the TCF and all interested parties.

20.2 Transit or Bypass Carrier

A Transit Carrier or Bypass Carrier is purely an intermediary carrier in the call delivery process. A Transit Carrier or Bypass Carrier plays no active part in database lookups or route determination. A Transit Carrier or Bypass Carrier must:

(a) ensure that Bilateral Agreements between the new entrant and other Network operators to whom the new entrant will connect are in place;

(b) interconnect Network testing between Networks to ensure satisfactory transiting of LMNP related signalling messages is complete. The exact detail and requirements of this testing will vary between Network operators; and

(c) provide contact details for support and escalation purposes to the TCF and all interested parties.

20.3 New Network Operator

A new Network operator is a new Donor Carrier on the New Zealand market that has its own Local Number or Mobile Number ranges, and that qualifies under the Telecommunications Act as an access seeker or access provider in relation to the Local Number Portability and Mobile Number Portability services.

A new entrant Network operator must:

(a) to the extent it acts as a Contracted Service Deliverer, comply with section 20.1 of these Network Terms; and

(b) to the extent it acts as a Transit Carrier or Bypass Carrier, comply with section 20.2 of these Network Terms,

and, in addition, must:

(c) ensure it has valid assignment of Local Numbers or Mobile Numbers and HOC codes;

(d) complete Network testing successfully, including call origination and delivery to the interconnection points; and

(e) provide contact details for support and escalation purposes to the TCF and all interested parties.

Formatted: Indent: Left: 18 pt

Deleted: n

Deleted: r

Formatted: Bullets and Numbering

Deleted: p

Formatted: Indent: Left: 0 pt, Hanging: 27 pt

Formatted: Bullets and Numbering

Deleted: They

Deleted: ensure that

Formatted: Bullets and Numbering

Formatted: Bullets and Numbering

Formatted: Bullets and Numbering

Deleted: have been provided

Deleted: ,

Deleted: under the Telecommunications Act

Deleted: s

Deleted: ,

Deleted: and

Formatted: Bullets and Numbering

Formatted: Bullets and Numbering

Formatted: Bullets and Numbering

21 Audit Process

21.1 Audit for initial certification

As specified in clause 14.4 of the Network Terms, each Carrier will be required to provide a one-off certification that its Network complies with the Equivalent Service criteria based upon its design and implementation.

Certification must be carried out by an independent company and each Carrier shall bear its own costs for the certification.

21.2 Audit by the Enforcement Agency

The Enforcement Agency may, if it has reasonable grounds, conduct an audit.

If the Enforcement Agency is requested to undertake an audit of another Carrier, the Carrier requesting an audit must provide evidence to the Enforcement Agency establishing the reasonable grounds upon which the Enforcement Agency may undertake an audit. The parties must pay any audit costs pursuant to the principles set out in clause 14.5 of the Network Terms.

If the Enforcement Agency decides to audit any Carrier then:

- (a) the Enforcement Agency will give at least five (5) Business Days prior written notice of the decision to undertake an audit to the Carrier to be audited ("**Audit Carrier**") and advise who is to undertake the audit;
- (b) the Audit Carrier shall have five (5) Business Days to agree to the audit or submit in writing to the Enforcement Agency why the audit should not be undertaken;
- (c) the Enforcement Agency will consider any submission made in good faith and will then advise the Audit Carrier within five (5) Business days whether or not an audit will be undertaken. If no submission is received from the Audit Carrier, or the Audit Carrier advises that it agrees to the audit, the Enforcement Agency may, but is not required to, undertake the audit;
- (d) If the Enforcement Agency decides to undertake an audit then the audit will be undertaken in the following manner:
 - i. The Enforcement Agency will provide, to the Audit Carrier, not less than five (5) Business Days notice of the date of the commencement of the audit ;
 - ii. The audit will be conducted in a manner so as to provide minimal disruption to the day to day business activities of the Audit Carrier;
 - iii. The Audit Carrier will co-operate fully with the Enforcement Agency or nominated auditor to facilitate a timely audit process.
- (e) The Enforcement Agency will give the Audit Carrier five (5) Business Days to comment on any audit report before a final audit report is issued.

During Porting Fault

Each participating Carrier must maintain a nominated contact point (or points) at its Fault Reporting Centre that must be used by participating Carriers for the direct reporting of faults occurring during Porting ("**During Porting Fault**").

Post Porting Fault

Post Porting Faults are faults occurring after Porting, and are to be reported using existing fault reporting methods ("**Post Porting Fault**").

Fault Clearance During Porting, or Immediately Post Porting

If the Gaining Carrier or Host Carrier becomes aware of such a fault, the Gaining Carrier or Host Carrier may call the Losing Carrier or Donor Carrier's contact point(s) to report the fault after the Gaining Carrier or Host Carrier has completed the Standard Tests

If the Losing Carrier or Donor Carrier receives a call from the Gaining Carrier or Host Carrier it should check the status and validity of the Port Request associated with the fault identified by the Gaining Carrier or Host Carrier. If the Port Request is invalid or the Port Activation is not yet closed then the fault report can be held, pending resolution of the state of the Port.

If the Port Request is valid and the Porting has been completed, testing must be initiated by the Losing Carrier or Donor Carrier.

If testing does not identify the existence of a fault then the Losing Carrier or Donor Carrier must advise the Gaining Carrier or Host Carrier accordingly.

If testing does identify the existence of a fault, then the Losing Carrier or Donor Carrier must initiate the rectification of the fault.

Fault Reporting requirements

Each day, any Carrier that has had the responsibility for clearing a fault related to LMNP, must advise the Carrier that first reported the fault, and any other Carrier directly affected by the fault, of the rectification, clearance, or other status of the fault. Where it was found that the fault either did not exist, or the fault was not related to LMNP, that outcome shall be also included in the fault report.

Guide to LMNP Fault Management Timetable

The following table summarises the resolution targets that apply to fault resolution

Event	Resolution Target timeframe
Resolution of During Porting Faults	On the initial phone call or no longer than four (4) hours

Time for the Gaining Carrier to test that a Port has been successfully completed	Four (4) hours from the commencement of the Port but before 5pm
Time for the Losing Carrier/Donor Carrier to respond to a During Porting Fault	Two (2) hours
Immediate Post Porting Faults	End of the first full Business Day
Resolution of Special Investigations	Three (3) Business Days

All resolution targets may be improved by Bilateral Agreement.