



TSLRIC price review determination for the UCLL and UBA services

Presentation of the UCLL and UBA TSLRIC models

Commerce Commission

Ref: 2014-20-DB-ML-ComCom-Access ntw cost model

TERA Consultants
39, rue d'Aboukir
75002 PARIS
Tél. + 33 (0) 1 55 04 87 10
Fax. +33 (0) 1 53 40 85 15
S.A.S. au capital de 200 000 €
RCS Paris B 394 948 731

Presentation to the industry

This slideshow illustrates the models and documents issued by the Commerce Commission. In case of discrepancies with the models, the model reference paper, the model specifications or the model documentation, statements within this slideshow should be disregarded.

2 December 2014



Agenda

- **Context**
- Main modelling assumptions
- Modelling approach
- Model implementation and usage

Context

- The Commission has received FPP requests both for UCLL and UBA respectively in February 2013 and January 2014.
- TERA Consultants has been instructed by the Commission to calculate a price for the UCLL and UBA services in accordance with the FPP which is TSLRIC.
- These TSLRIC models for UBA and UCLL have been built on the basis of the methodological choices made by the Commission and described in its draft determinations.
- This presentation is a technical presentation of the TSLRIC models for UBA and UCLL and is structured as follows:
 - *Description of the main modelling assumptions;*
 - *Description of the modelling approach;*
 - *Description of the models implementation and how to use them.*



Agenda

- Context
- **Main modelling assumptions**
- Modelling approach
- Model implementation and usage

Main modelling assumptions for UCLL

Modern Equivalent Asset

- The MEA of UCLL is a nationwide network which coverage is achieved by a **mix between a fibre access network and a fixed wireless access (FWA) network.**
- The fibre + FWA network is based on:
 - *A FTTH point-to-point network; and*
 - *The LTE technology for the FWA part.*

Main modelling assumptions for UCLL

Cost adjustment

- The MEA is adjusted based on costs to reflect the fact that the regulated UCLL services are based on a FTTN network rather than a FTTH network.
 - *If the fibre + FWA network cost is lower than the copper network cost, then no adjustment is needed;*
 - *If the copper network cost is lower than the fibre + FWA network cost:*
 - then the cost of the fibre + FWA network is adjusted to reflect the cost of the copper network;
 - this means the cost of the copper network is used to derive the prices.
- The lowest cost roll-out scenario is selected by comparing **at the national level** the annual cost of both networks (depreciated CAPEX + OPEX + non network costs).
- **Two roll-out scenarios** have therefore been modelled:
 - *FTTN;*
 - *PTP FTTH + FWA at the edge.*

Main modelling assumptions for UCLL

Optimisation

- 
- **The modified scorched node** approach has been followed:
 - *the network roll-out follows the road network;*
 - *existing nodes of the copper access network (exchange, SC) are the starting points of the modelling;*
 - *for the fibre network, the following assumptions have been made:*
 - the fibre exchanges are located at Chorus' copper local exchanges;
 - the fibre local exchanges coverage areas are Chorus' copper local exchanges coverage areas;
 - It is not constrained by Chorus' copper street cabinets (SC);
 - *modifications have been made to take into account:*
 - notional exchanges (modification to the existing copper nodes);
 - network connectivity constraints (modification to the road network database).
 - Wired networks are optimised in order to **minimise the distance of each line.**

Main modelling assumptions for UCLL

FWA

- In line with the modified scorched node approach:
 - *the locations of the FWA sites are the locations of Vodafone's RBI sites (535 sites included in the model);*
 - *the coverage of the FWA sites is the coverage of Vodafone's RBI sites.*
- The capacity of the FWA sites (in terms of number of customers) is defined by:
 - *the site capacity at peak hour (in Mbps); and*
 - *the customers' peak hour throughput (in kbps).*
- The dwellings served by FWA are selected on the basis of the two following constraints:
 - *the dwellings should be located in the FWA RBI coverage area; and*
 - *the dwellings are the most expensive to connect by fibre.*

Main modelling assumptions for UCLL

Other main modelling assumptions

- The capital costs of rolling out the access network **outside the TSO-derived boundary* are not included** to derive the prices.

- The **demand** has been defined as follows:
 - *Stable over the price control period;*
 - *Made of:*
 - Chorus' copper customers;
 - Chorus' fibre customers;
 - LFC's fibre customers;
 - *HFC customers are excluded from the demand.*

- The network is based of a **mix of overhead and underground infrastructure:**
 - *49% of the lead-in network is overhead;*
 - *36% of the distribution + feeder network is overhead.*

*As defined in the Commission's draft determination for UCLL, paragraph 270

Main modelling assumptions for UCLL

Avoiding double recovery

- The technical scopes of the PTP FTTH + FWA network and the FTTN network are different:
 - *The PTP FTTH + FWA network links all the customers to an exchange;*
 - *The FTTN network links the customers either to an active cabinet or to an exchange.*

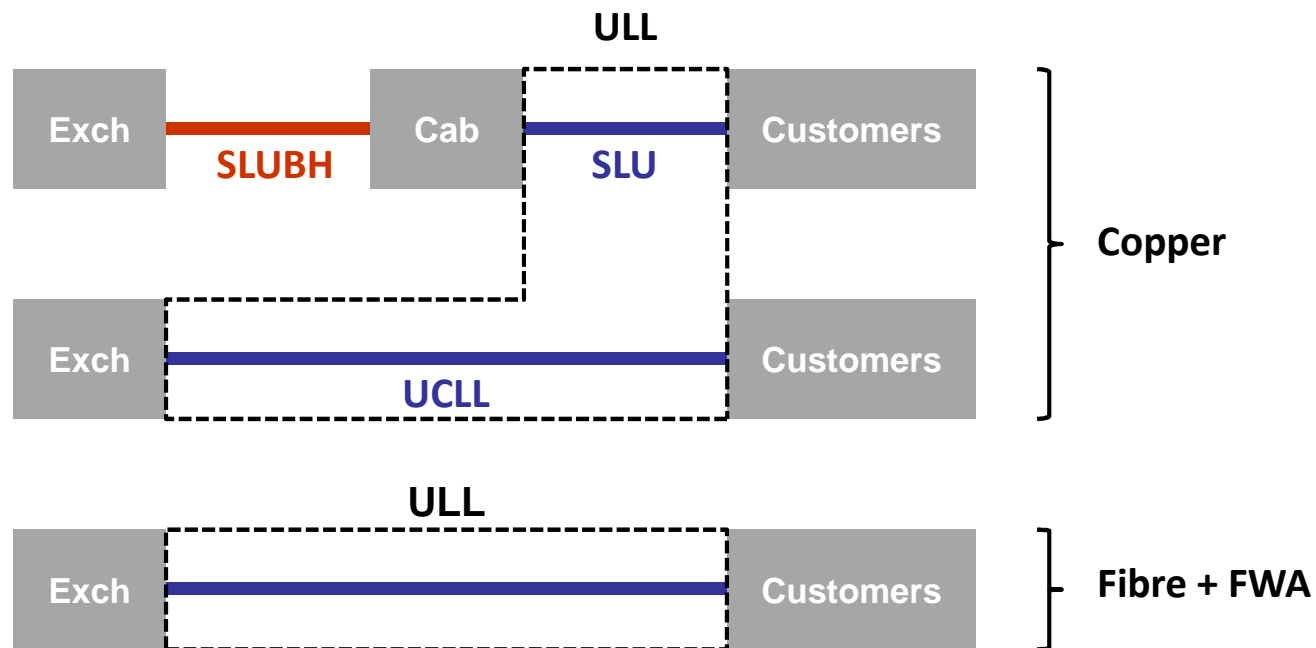

- The cost of the SLUBH is thus already accounted for in the cost of the PTP FTTH + FWA network.

Main modelling assumptions for UCLL

Deriving UCLL and SLU

- The FTTN network is made of 2 configurations:

Customers connected to the exchange (UCLL):

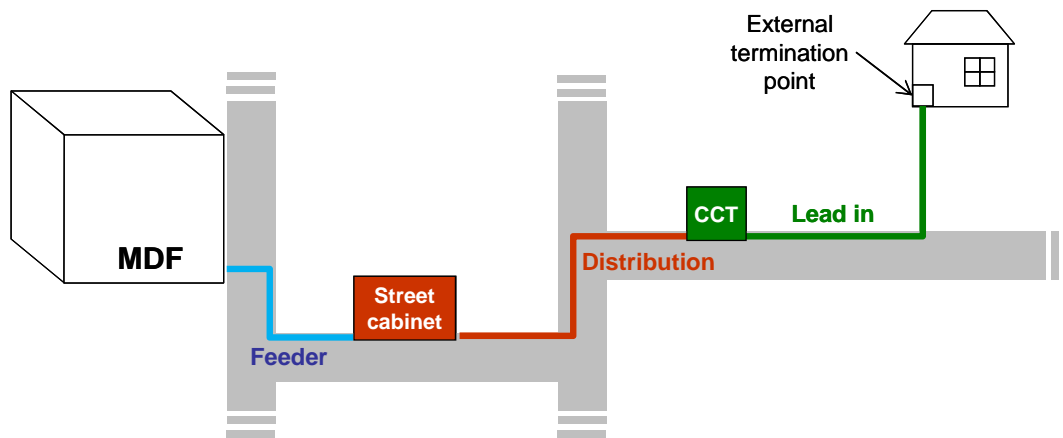

Customers connected to the cabinet (SLU):

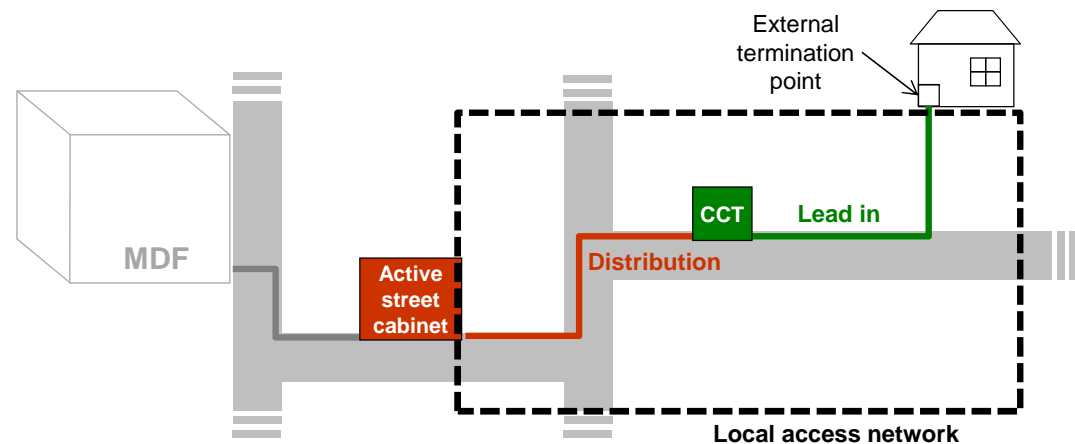

- The TSLRIC calculates first the cost of ULL and then derives UCLL and SLU costs.
- The different regulated services are verifying the following relationships:

Where:

$$UCLL = SLU + SLUBH$$

$$ULL = \alpha * SLU + \beta * UCLL$$

- *SLU is the cost of the lead-in + the distribution of the cabinetised lines*
- *SLUBH is the cost of the link between the active street cabinet and the exchange*
- *ULL is the cost of connecting all customers to a DSLAM*
- *α is the share of active lines connected at the cabinet*
- *β is the share of active lines connected at the exchange*

Main modelling assumptions for UBA

Modern Equivalent Asset

- The MEA of the core network is based on:
 - *A copper/FTTN access network architecture; and*
 - *an NGN Ethernet core network to support broadband.*
- Legacy technologies such as ATM are therefore not modelled.
- The UBA service stops at the First Data Switch (FDS) where the RSP buys:
 - *Either the handover connection service;*
 - *Or the Tail Extension Service.*
- Given this scope, 3 types of active network assets are needed in the core model:
 - *The DSLAMs located in the cabinets;*
 - *The DSLAMs located in the exchanges; and*
 - *The FDS.*

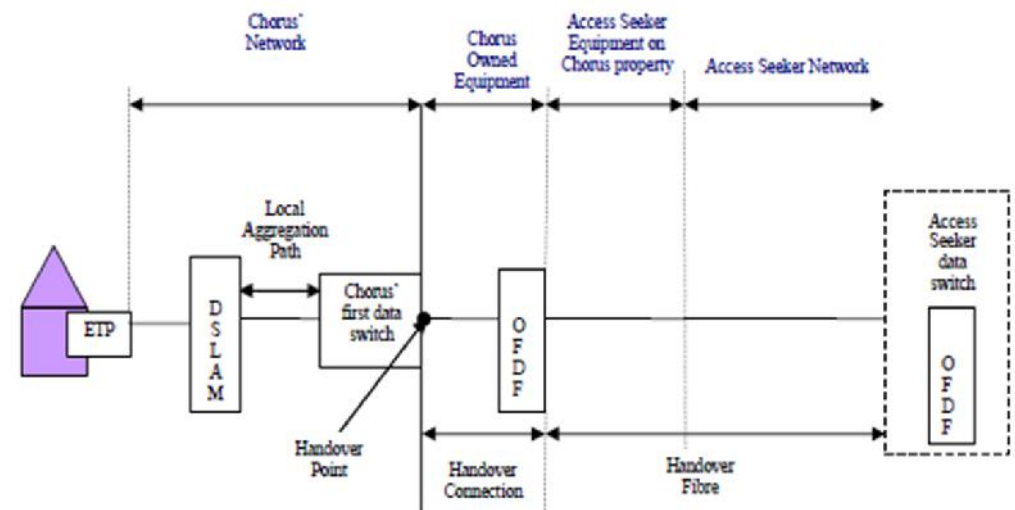

Source: STD for Chorus' unbundled bitstream access service

Main modelling assumptions for UBA

Other main modelling assumptions

- The capital costs corresponding to the DSLAM included in the RBI program are not taken into account to derive the regulated prices.
- The demand has been defined as follows:
 - *Stable over the price control period;*
 - *Made of Chorus' bitstream customers i.e. the demand for regulated and non-regulated bitstream services.*

Common modelling assumptions for UBA and UCLL

Cost allocation

- The **capacity based allocation** approach is used to allocate network costs:

Asset class	Capacity driver
Trenches	Ducts
Ducts	Surface of the cables inside of the ducts
Copper cables	Pairs
Fibre cables	Fibres
DSLAM	Active customers
Switches	Ports

- The **EPMU** approach is used to allocate non-network costs.

Common modelling assumptions for UBA and UCLL

Remaining assumptions

- 
- The costs are valued using optimised replacement costs.
 - The costs are depreciated using a **tilted annuity formula allowing to take into account the tax shield**. Parameters are:
 - *A post-tax nominal WACC of 6.47%;*
 - *A 6 month time to build.*
 - The price control period lasts 5 years from 2015 to 2019.
 - Chorus access network OPEX are adjusted to reflect:
 - *The cost of a new network; and*
 - *The cost of a fibre network.*



Agenda

- Context
- Main modelling assumptions
- **Modelling approach**
- Model implementation and usage

UCLL modelling

3 network configurations to be modelled

FTTN network, non-cabinetised line

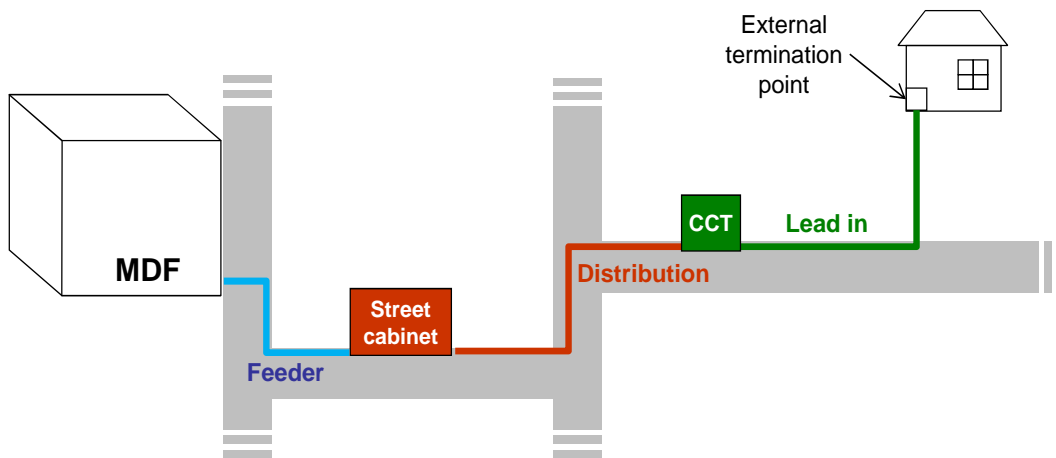

FTTN network, cabinetised line

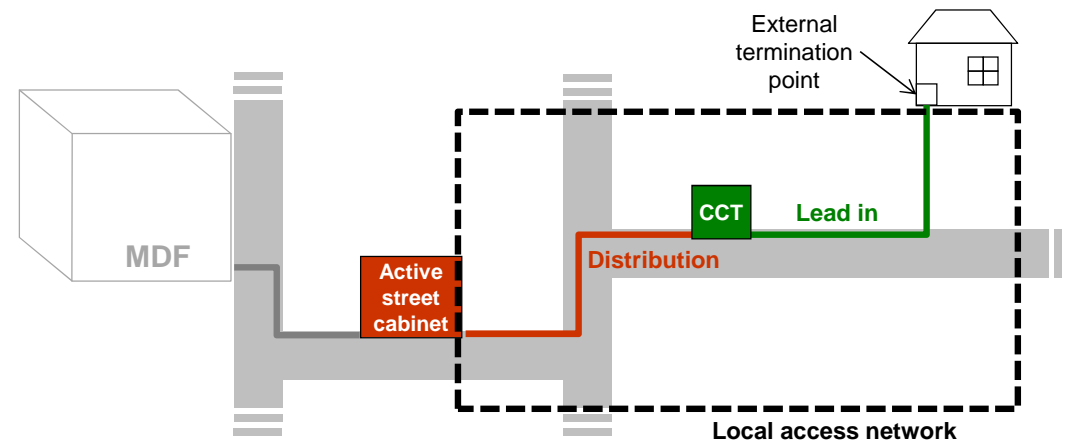

FTTH network

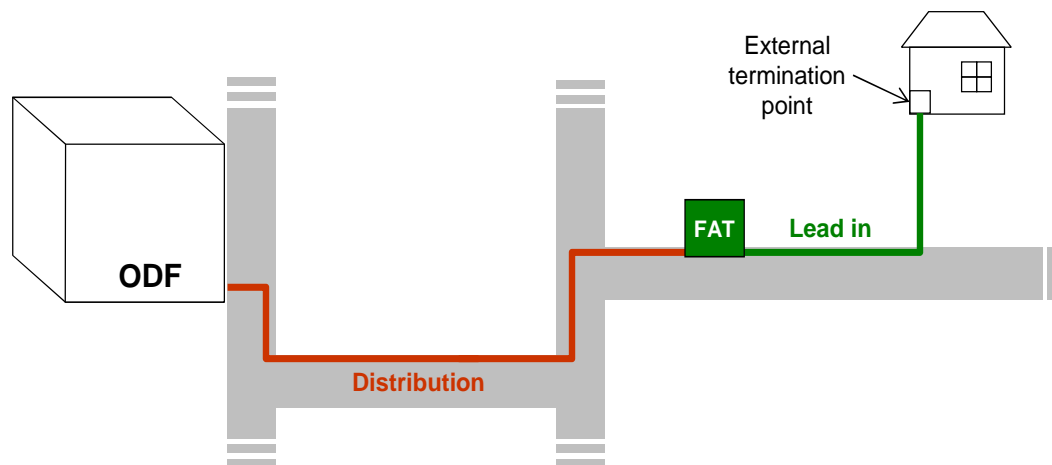

UCLL modelling

Geospatial inputs have been used extensively



File reference	Content
Corelogic Terrabase road and address database	Road and rail network, address points, and address categories.
Landcare Research New Zealand Ltd, Land Resource Information System (LRIS) spatial data layers	Rock lithology
Statistic NZ 2013 Census Data	2013 Meshblock and Census Data
CERA – Red Zones	Areas zoned red where earthquake damaged land is unlikely it can be rebuilt on for a prolonged period.
Land Information New Zealand (LINZ) Survey Parcels	Survey Parcels, Legal Road Centerlines
Building footprints	Building footprints for Auckland City, Christchurch City, Kapiti District, Porirua City, Tauranga City, and Wellington City councils, The data was either downloaded directly or used via an open web service.
Chorus Data	Exchange sites and boundaries, cabinet locations, cable paths
Vodafone RBI Sites and Coverage	Name and coordinate of existing and proposed sites and coverage of final (2019) RBI coverage.

UCLL modelling

Road network and exact location of all buildings



UCLL modelling

Soil rock classification of each road

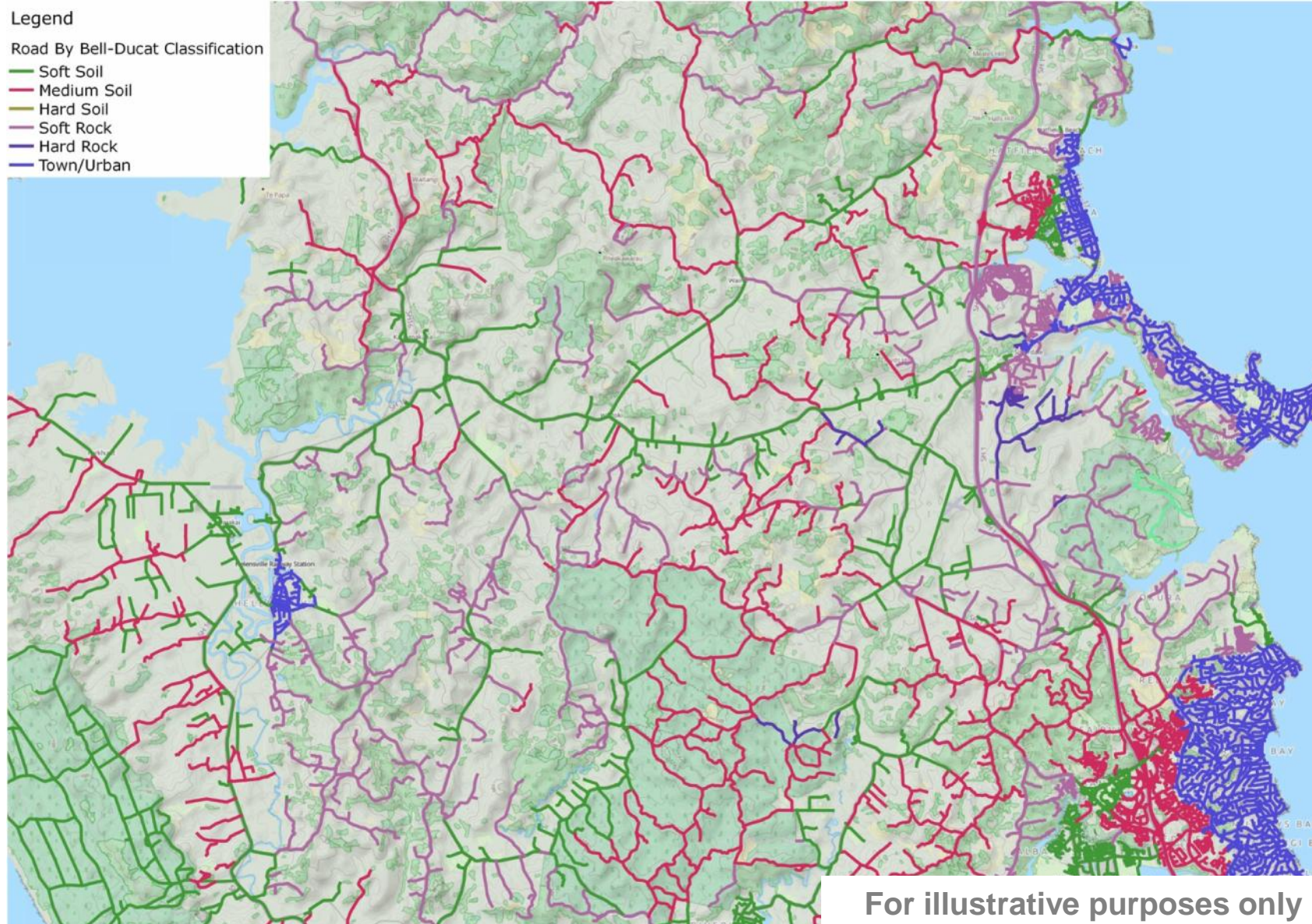

UCLL modelling

Copper network roll-out

- 1 Starting point: the location of the existing copper nodes and the MDF coverage areas

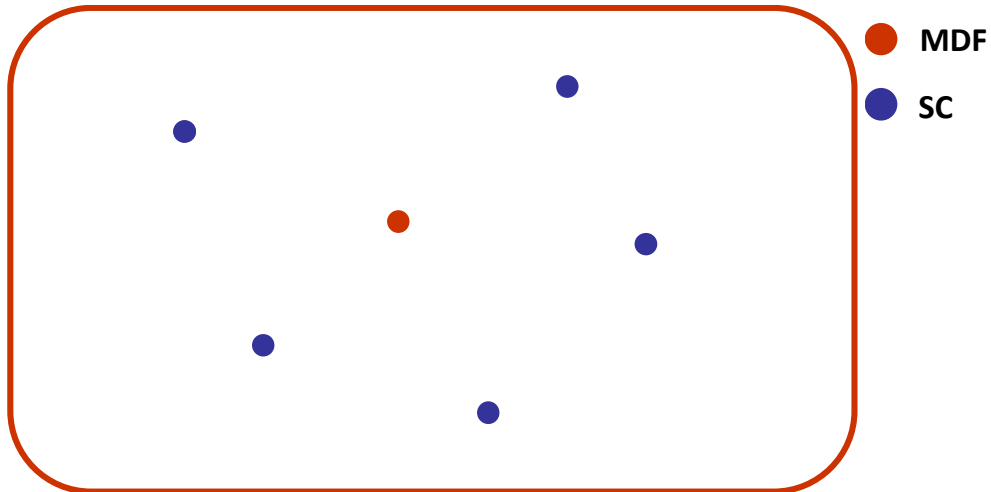

- 2 Each MDF coverage area is split into SC coverage areas.

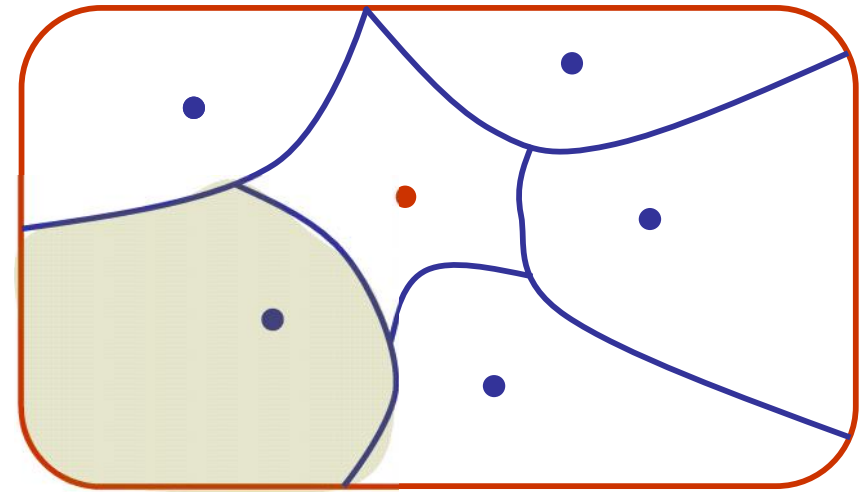

- 3 Each building is linked to its parent SC using the shortest path algorithm

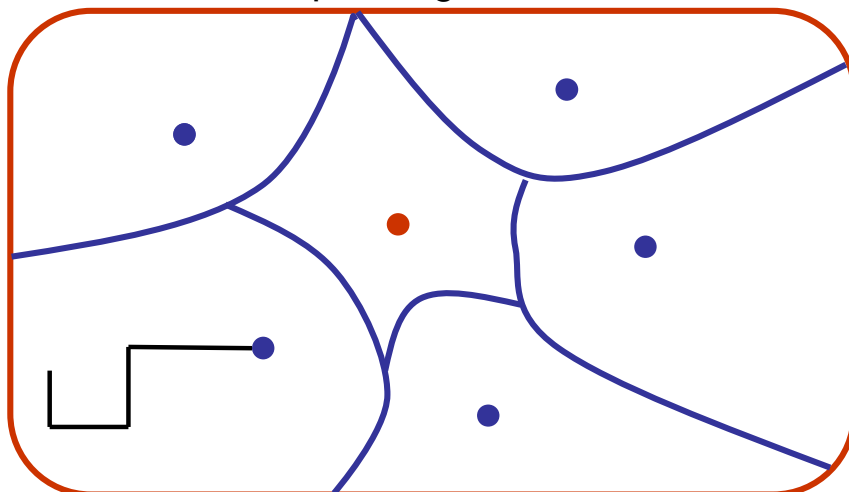

- 4 Each SC is linked to its parent exchange using the shortest path algorithm

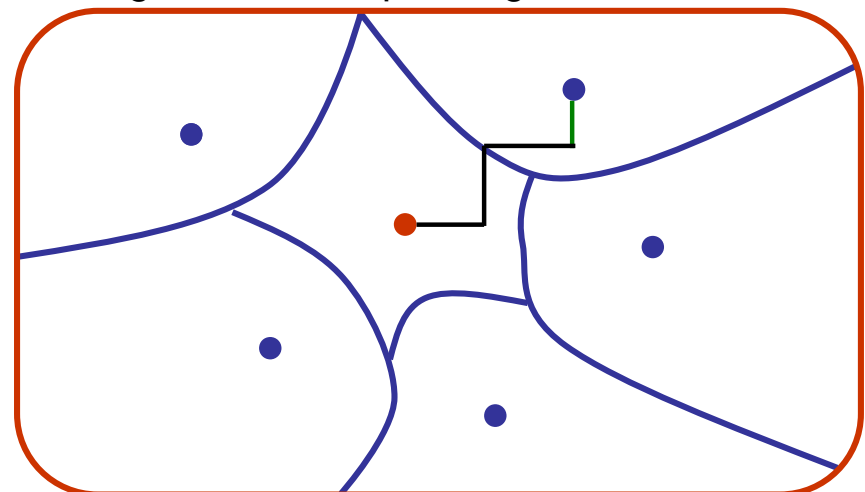

UCLL modelling

MDF coverage areas

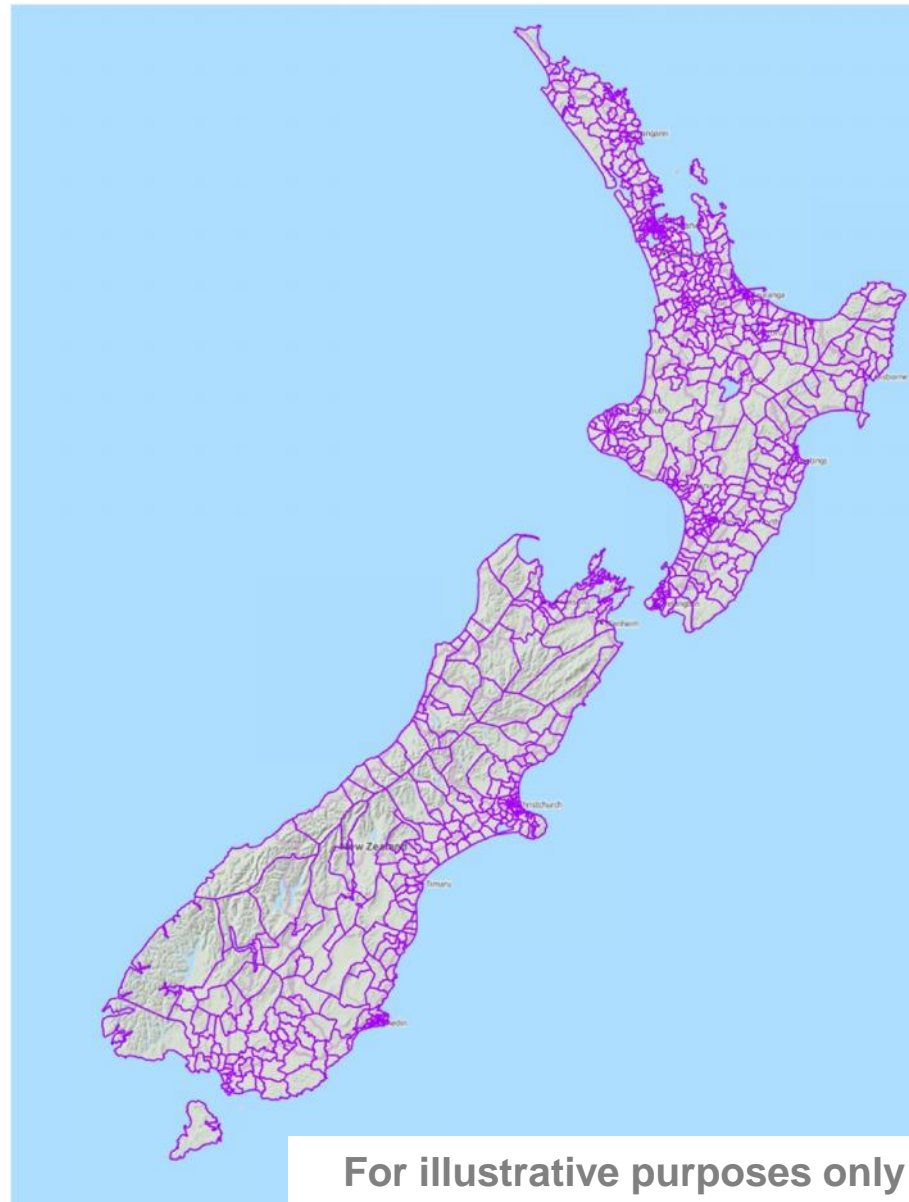

UCLL modelling

SC coverage areas

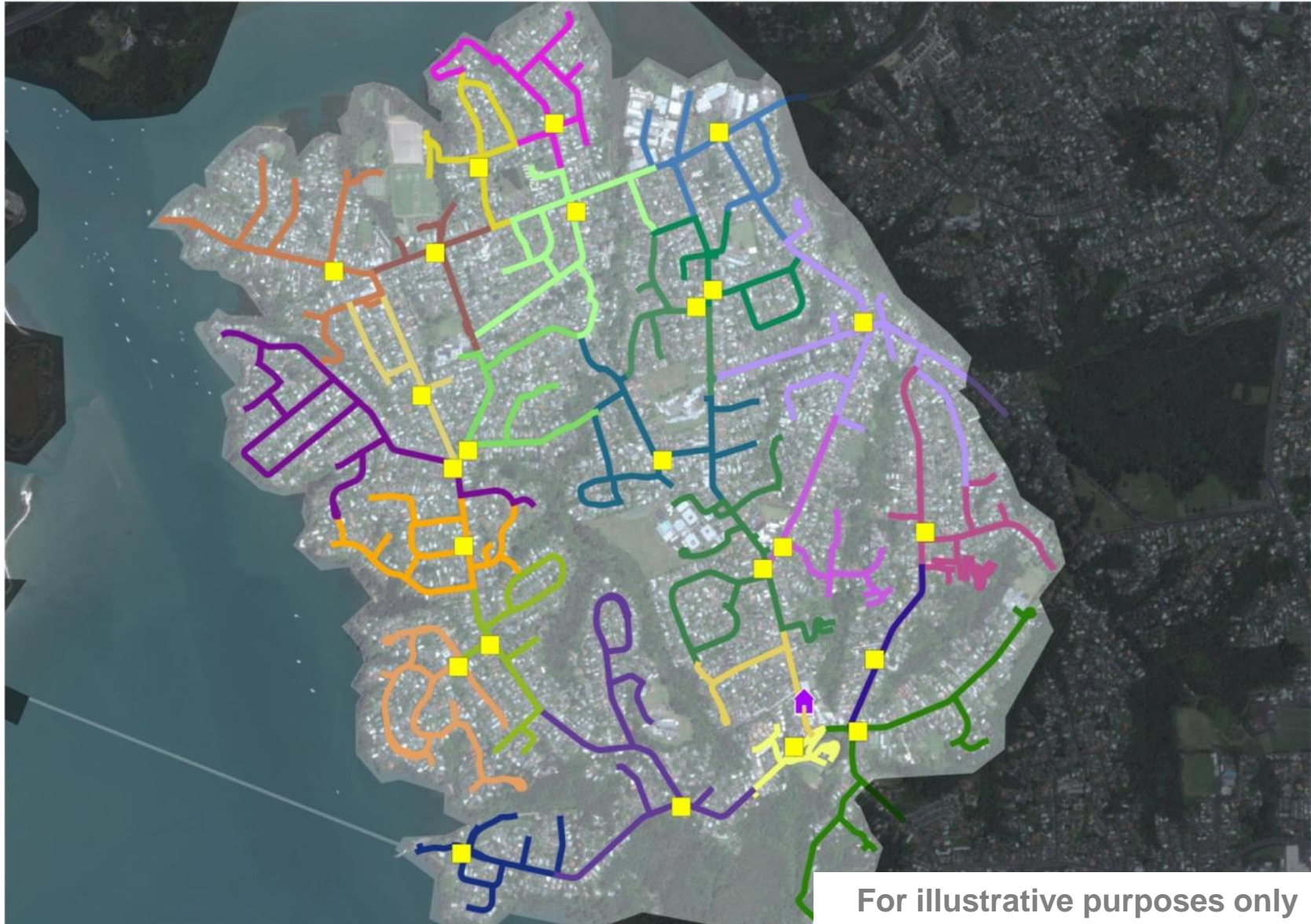

For illustrative purposes only

UCLL modelling

Shortest path algorithm for the copper network

Links between the buildings and the SC



For illustrative purposes only

UCLL modelling

Fibre network roll-out



- 1 Starting point: the location and the coverage areas of the existing copper exchanges are used as the location and the coverage of the modelled fibre network

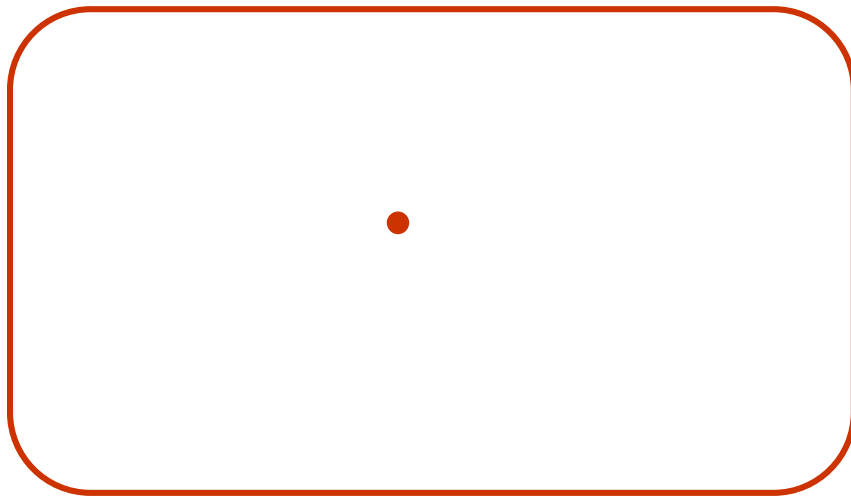

● MDF

- 2 Each building is linked to its parent exchange using the shortest path algorithm

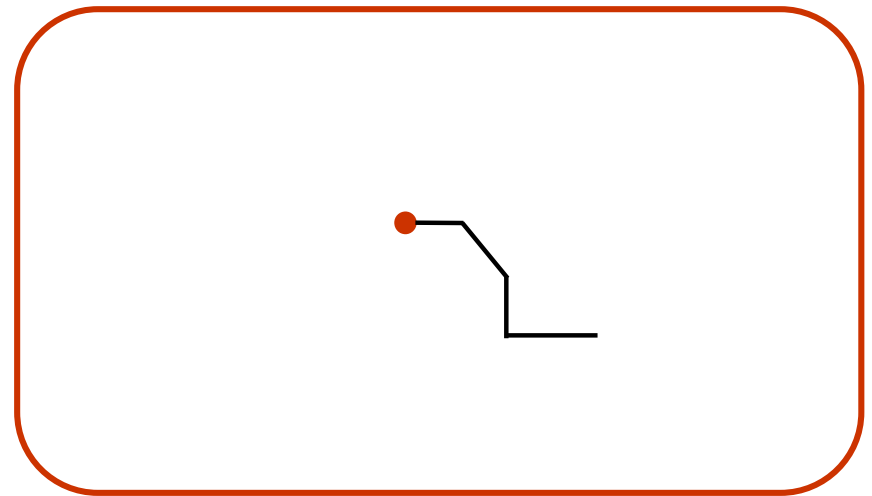

UCLL modelling

Shortest path algorithm for the fibre network



For illustrative purposes only

UCLL modelling

Civil infrastructure sharing

- 
- The access network shares its trenches with other networks:
 - *The core network:*
 - Inter Exchange links;
 - DWDM links;
 - Submarine links;
 - *Access part dedicated the fibre leased lines;*
 - *FWA backhaul.*
 - These routes used by these networks have been modelled* in order to capture the relevant economies of scale/scope.

* The access part of the leased lines has not been modelled due to the lack of data but the economies of scale have been estimated

UCLL modelling

Modelling of the inter-exchange links

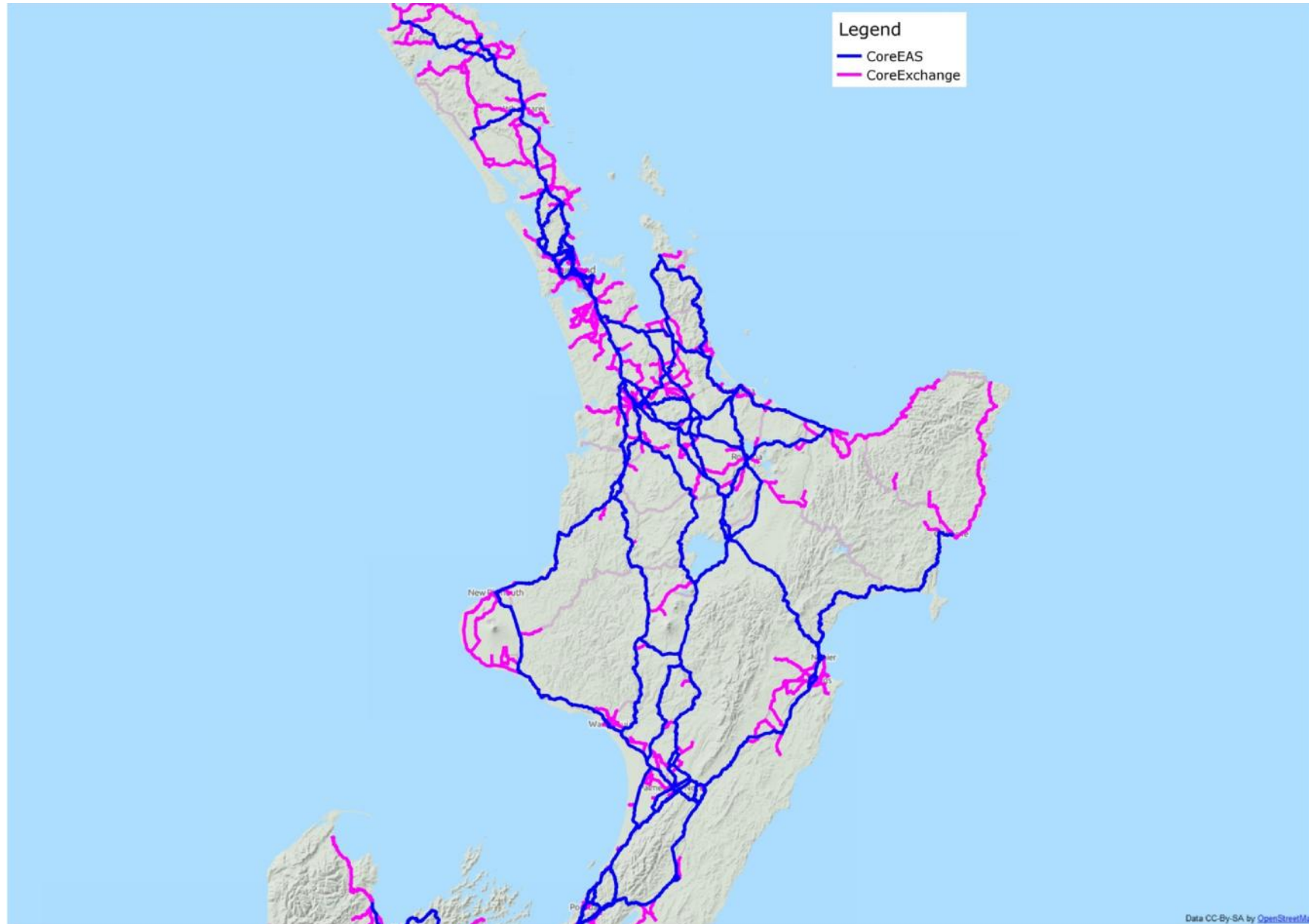

UCLL modelling

Overview of the access network dimensioning

- The access network (copper and fibre) is dimensioned section per section (a section is a part of a road/street between two consecutive intersections), knowing:
 - **The demand of the section:** the number of lines on the section plus on its rear area;
 - **The features of the section:** length, buildings location, number of dwellings per building, etc.
- First, the distribution points on the section and their location;
- Then, the assets dedicated to each building are dimensioned:
 - The lead-in cables (length and size);
 - The dedicated civil engineering.
- Finally, the assets shared between the different buildings of the section are dimensioned:
 - The cables and joints (size, length), according to the local demand and section configuration;
 - The civil engineering, shared among access network and core network.

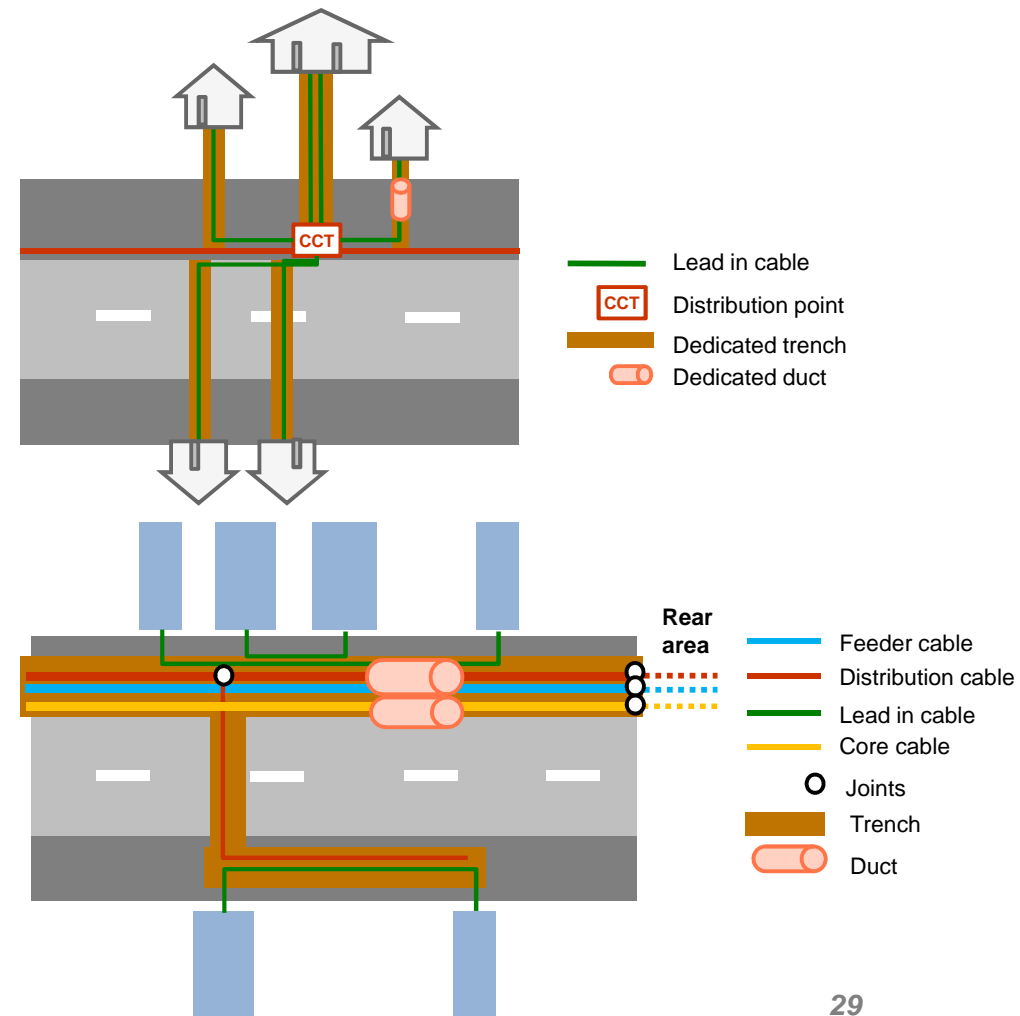

UCLL modelling

Engineering rules

- The access network dimensioning follows a set of engineering rules that either stem from Chorus technical papers or are cost-effective:

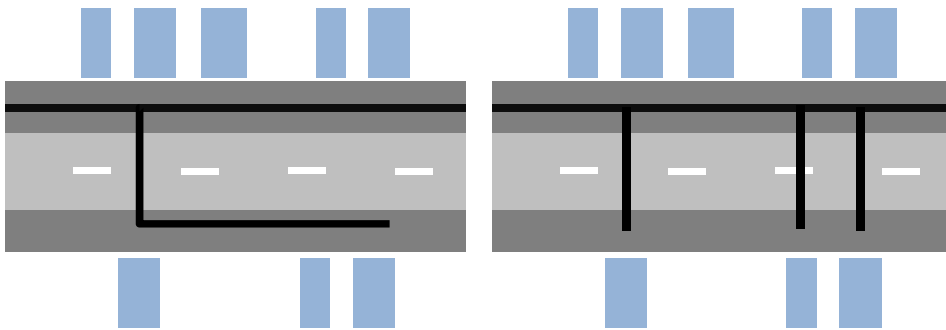

- The section is trenched on one side or on both sides according to the cost-efficient solution.

- Distribution points (CCT, FAT) are dimensioned given their capacity and are deployed uniformly along the section.
- The lead-in cable is then deployed from the building to the closest distribution point (crow-fly distance when overhead).

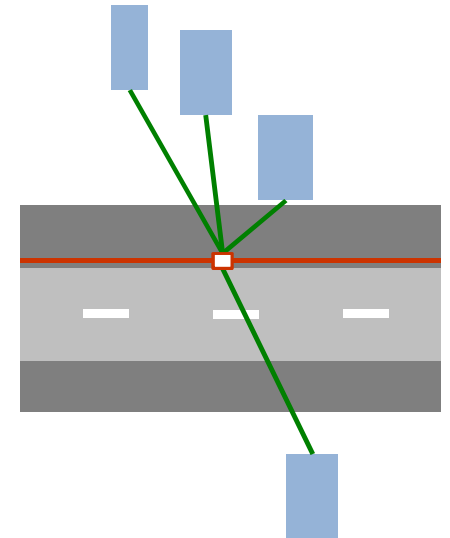

- The distribution cable is dimensioned to meet:
 - The local demand and the rear area demand;
 - Chorus design rules in terms of number of pairs/fibres.

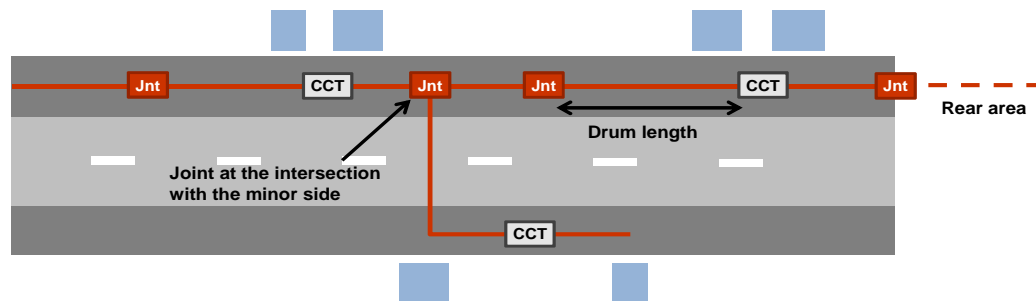
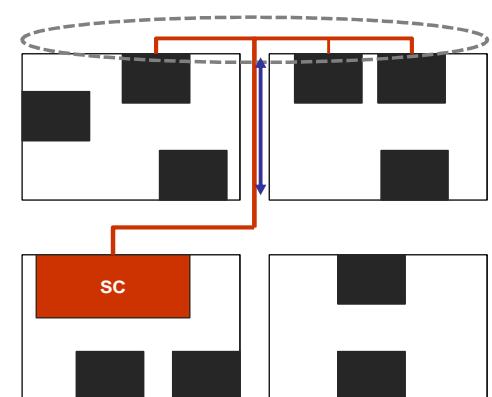

- Joints are deployed at the intersection with other sections and along the section according to the cables' standard drum length.

UBA modelling

Scope of core model

- The UBA service uses active assets and passive assets.
- The provisioning of the UBA service stops at the FDS.

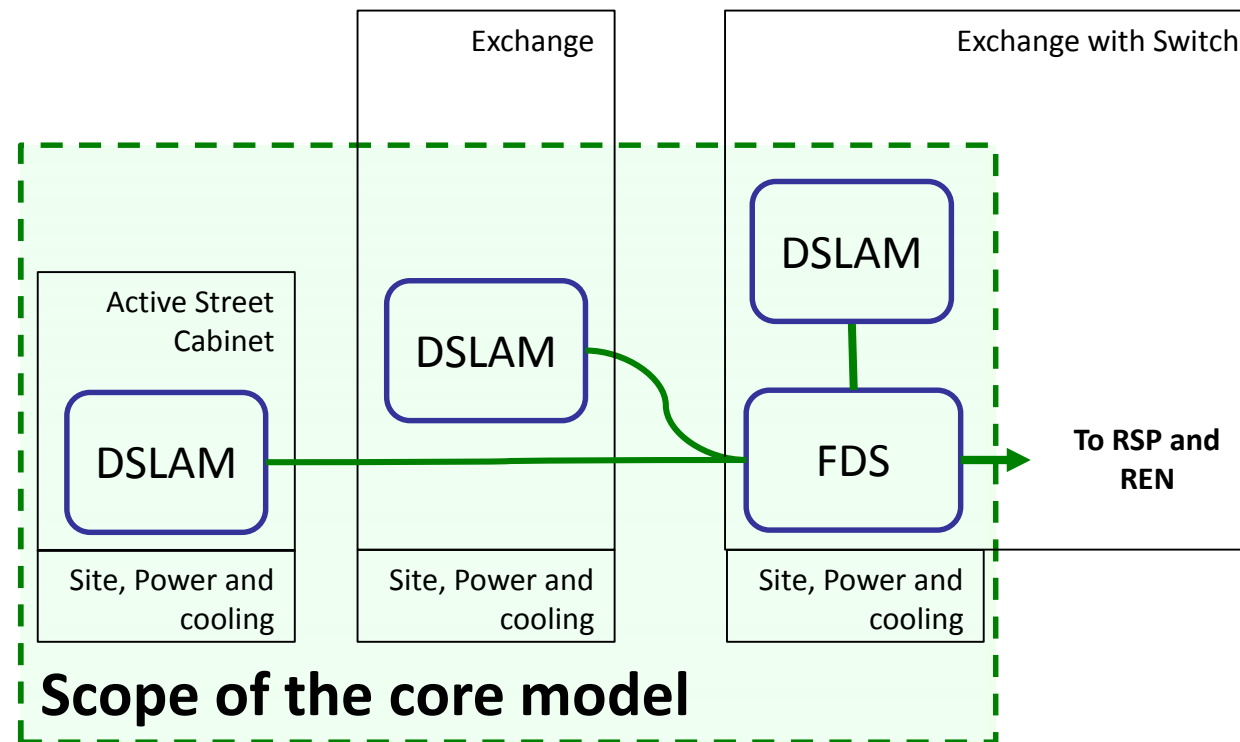

- The price of the UBA service is the sum of:
 - *The UCLL price;*
 - *The additional costs used to provide the UBA service.*

UBA modelling

Network assets - DSLAM

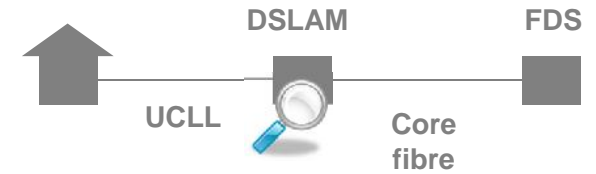

- DSLAMs are the assets used to provide DSL services over copper cables.
- They are located in Chorus sites (cabinets or exchanges).

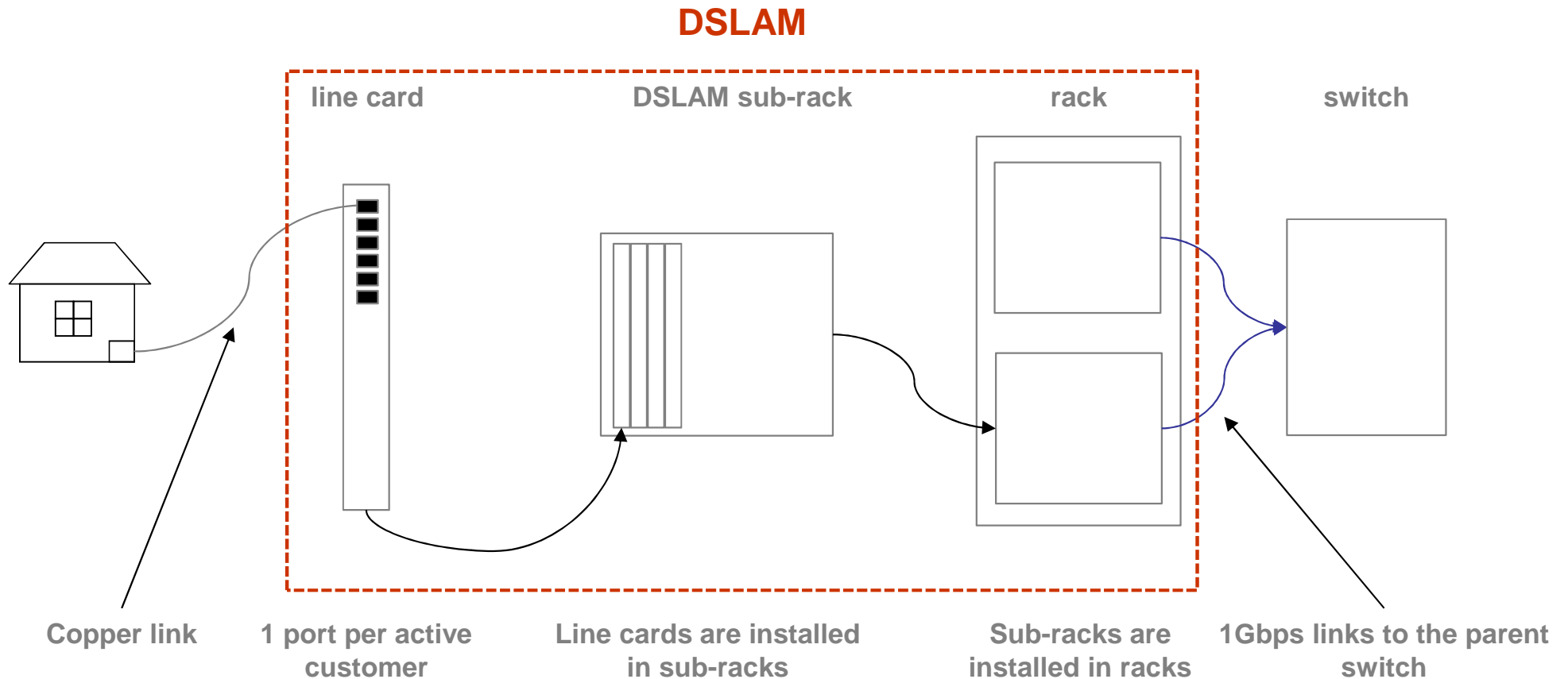

UBA modelling

Network assets - FDS

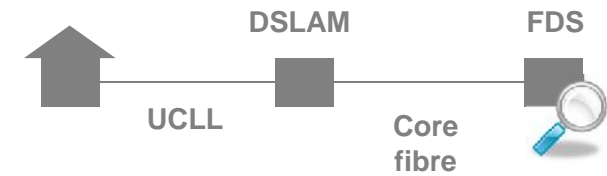

- The first data switch (FDS) aggregates traffic from DSLAMs:
- It is also the point of interconnection for:
 - The RSP;
 - The REN network.

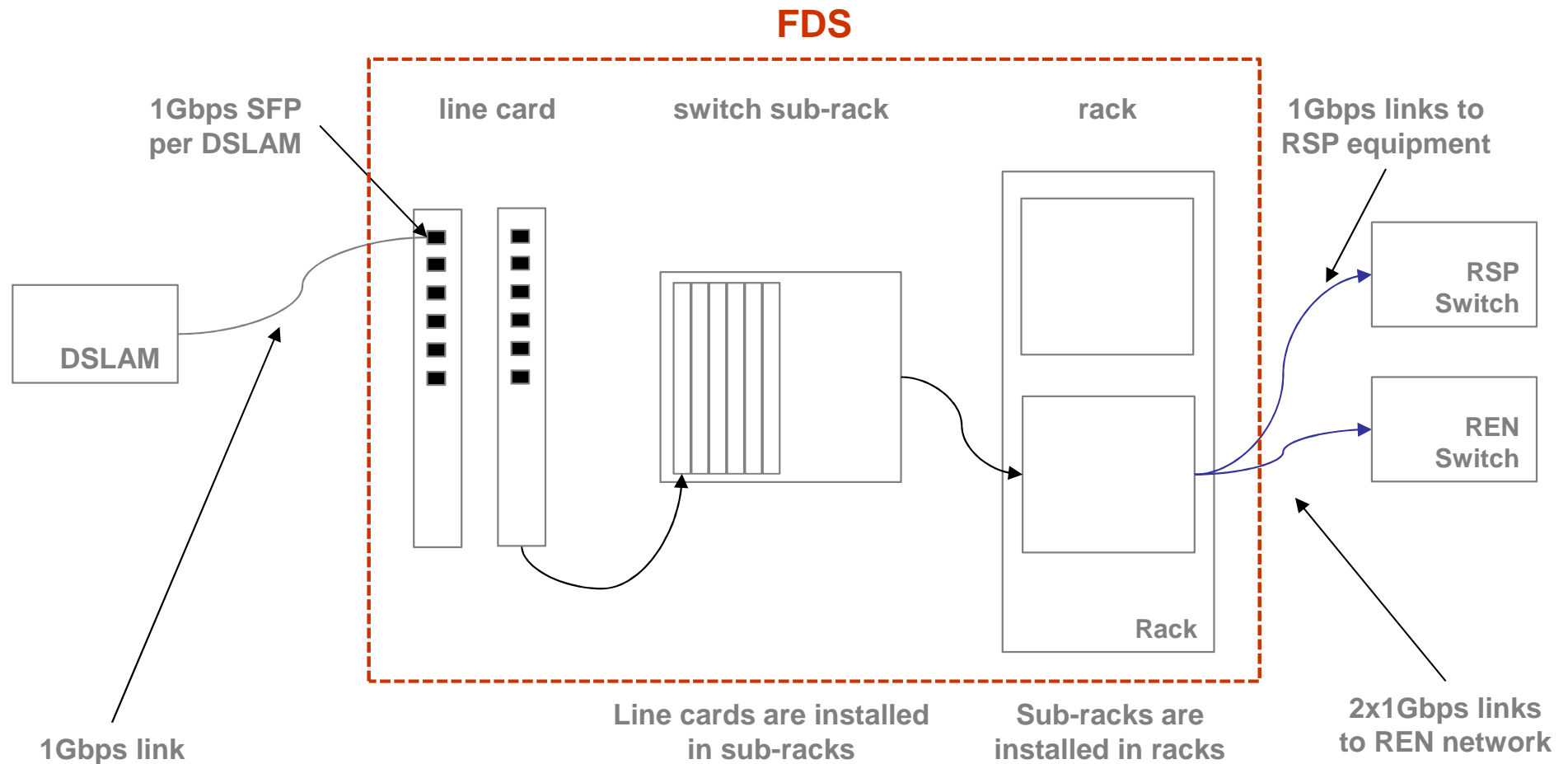

UBA modelling

Dimensioning active assets

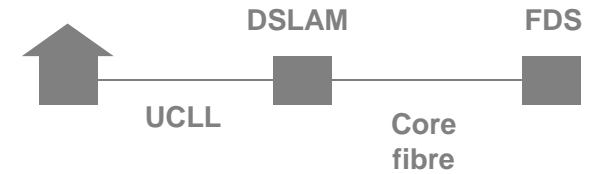

Modelling of a DSLAM in a cabinet

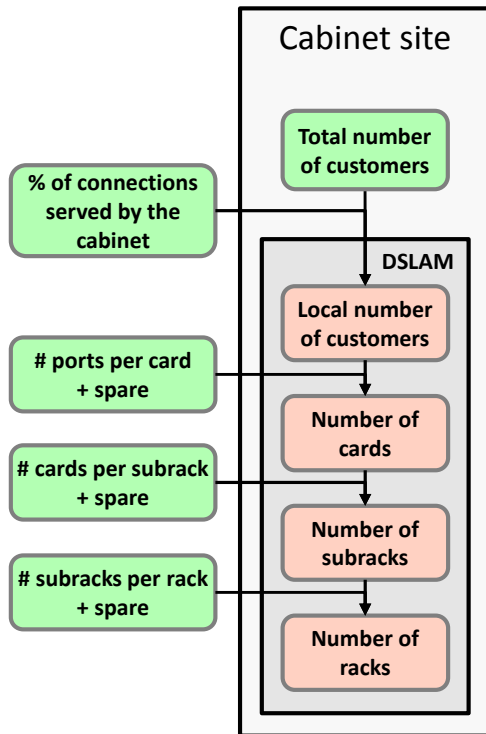

Modelling of a DSLAM in an exchange without a FDS

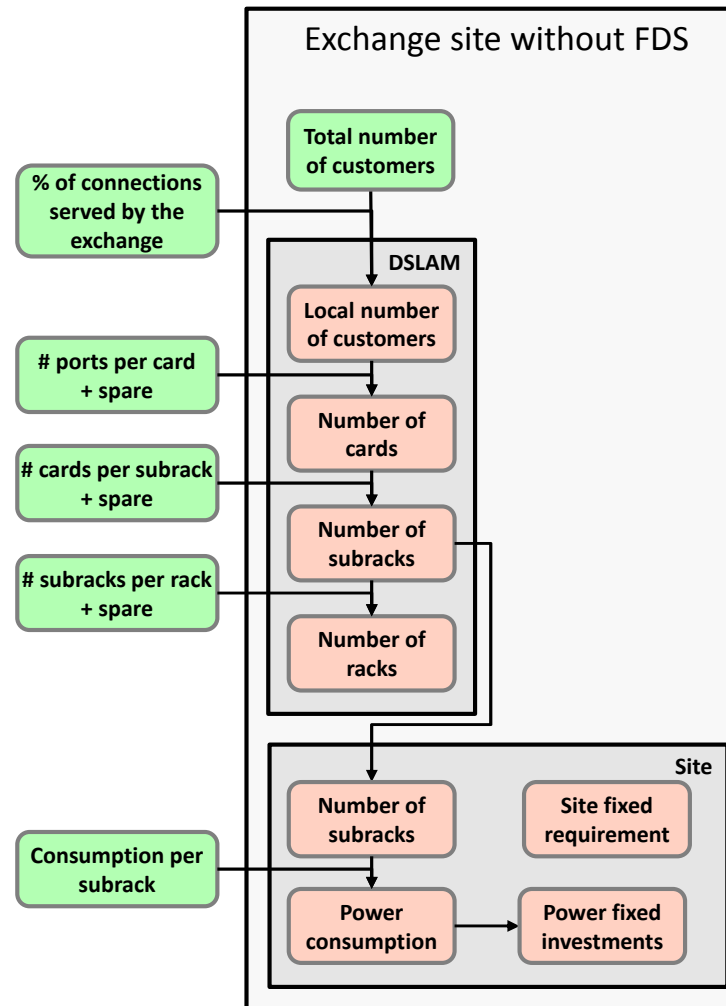

Modelling of a DSLAM and a FDS in an exchange with a FDS

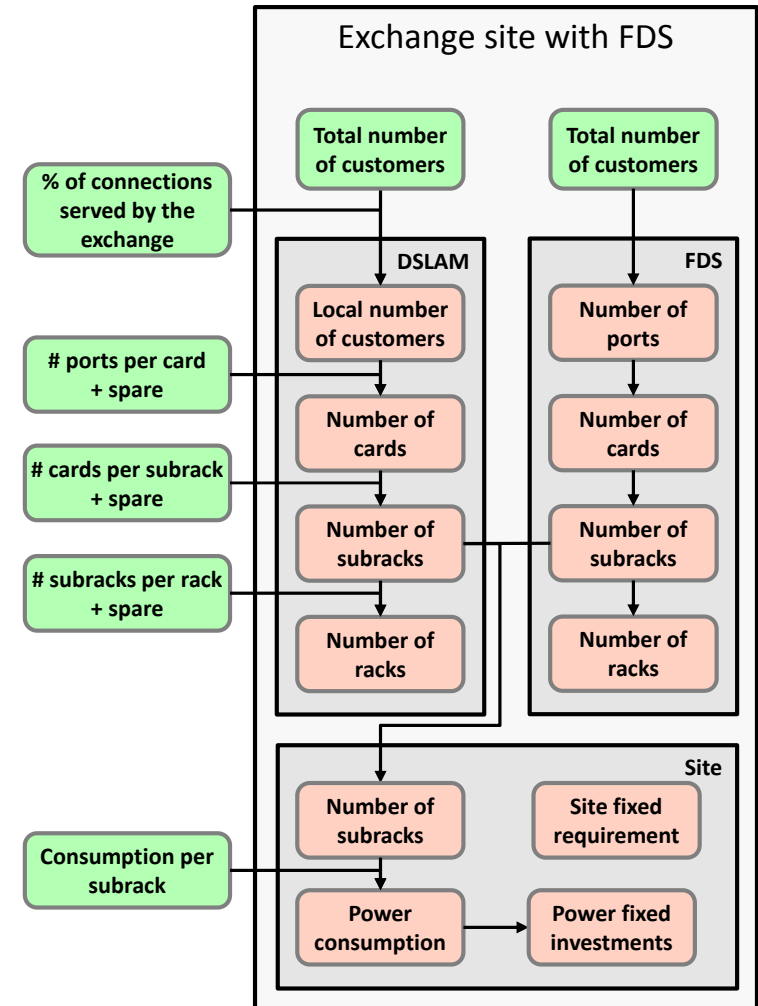

UBA modelling

Passive assets – fibre links

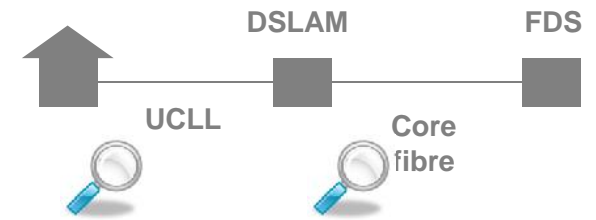

- Chorus' core fibre network is used to provide backhaul for DSLAMs and is therefore supporting bitstream services (regulated or not).

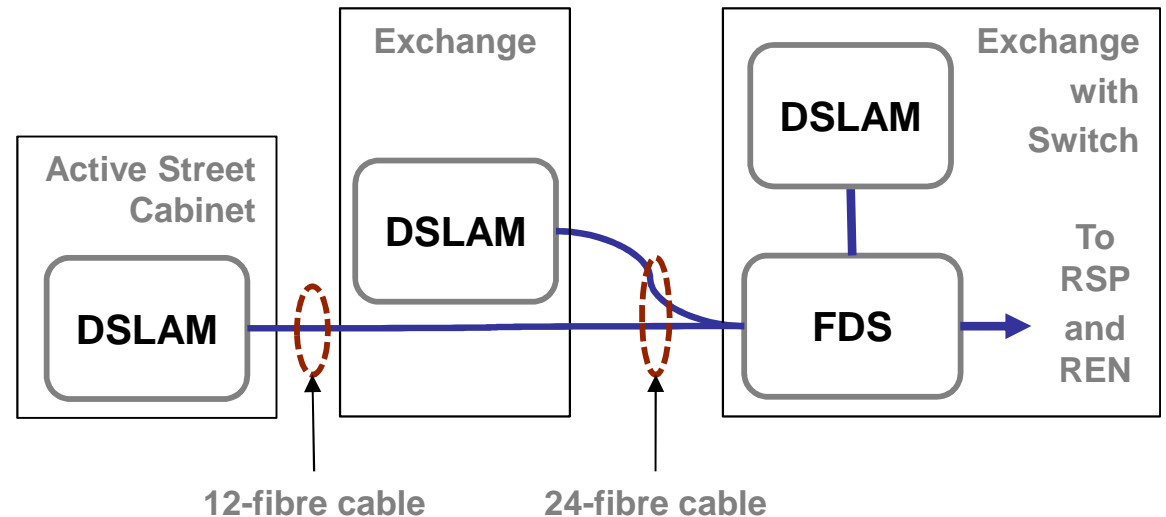

- Chorus' core fibre network is also used to connect FDS together (REN), to provide dark fibres, to provide leased lines/connectivity services, etc.
- The fibres are thus shared between several services. All these services should therefore bear a share of the cost of these links, based on the capacity they use, i.e. based on the number of fibres they require. The assumptions are given in the table.

Parameter	Share allocated to bitstream services	Share allocated to other services
Link between active cabinets and their parent exchange	2/3	1/3
Link between exchanges and their parent FDS exchange	1/3	2/3

OPEX model

OPEX model structure

- A separate model calculates OPEX for UBA and UCLL.
- The starting point is Chorus' OPEX.
- The network OPEX calculation includes the following steps:

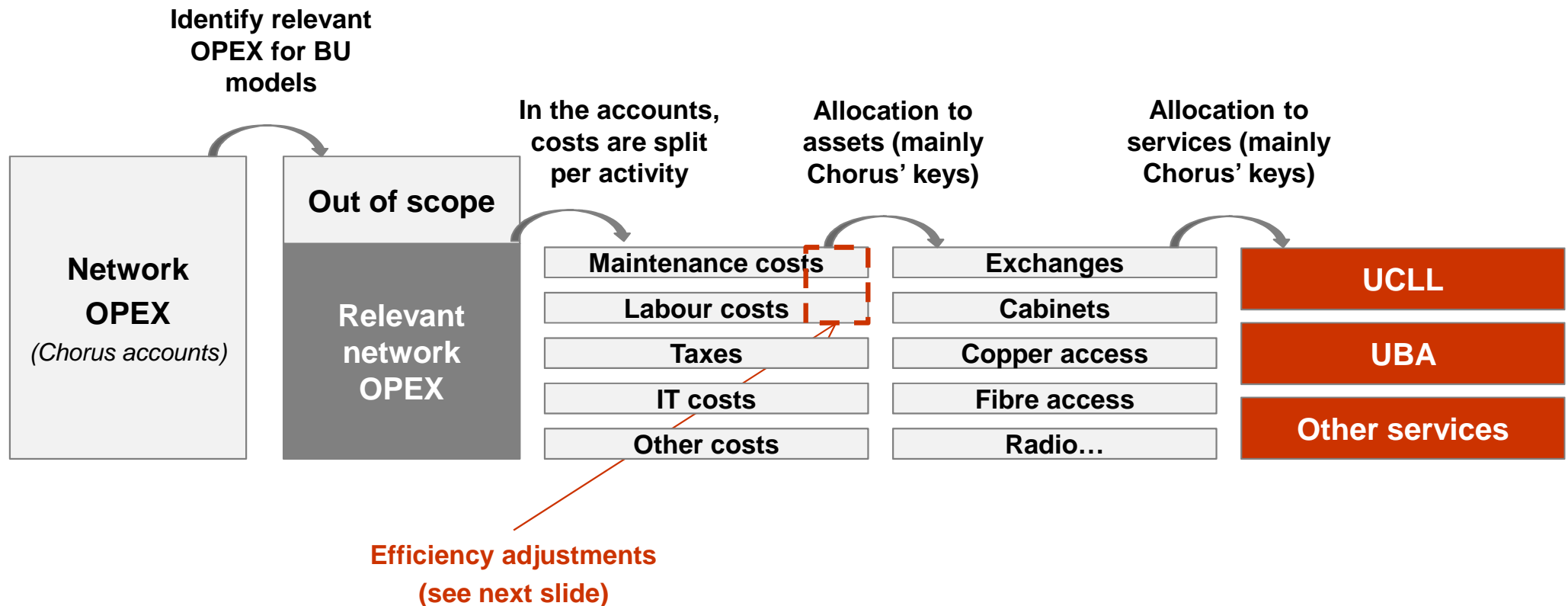

- Fibre OPEX are assumed to be equal to 50% of Copper OPEX (based on regulators/manufacturers studies)
- FWA OPEX includes spectrum fees + maintenance OPEX

OPEX model

Focus on access network OPEX efficiency adjustment

- In accordance with the TSLRIC principles, network OPEX should be representative of a recently built network:
 - One of the main cost drivers of maintenance costs in the access network is the number of a line faults;
 - The number of faults increases with the age of the network;
 - To estimate an efficient level of costs representative of a recently built network, Chorus' maintenance costs need to be adjusted by using an 'efficiency factor'.
- The efficiency factor corresponds to the ratio between Real Chorus Line Fault Index (LFI) and the estimated LFI of a new network (based on benchmark data adjusted to NZ context):



- Maintenance contractors field costs
- Maintenance contractors overheads
- Chorus' own maintenance staff

Are adjusted based on the efficiency factor
(supposed to vary with the number of faults)

From dimensioning to pricing

Costing the networks

- The total investment is obtained by multiplying the inventory by the unit cost of the assets.
- The annual cost of the network is made of:
 - *The annuity (annual Capex);*
 - *The Opex; and*
 - *The common costs.*
- The annuity is derived using a tax adjusted annuity allowing taking into account the tax shield.

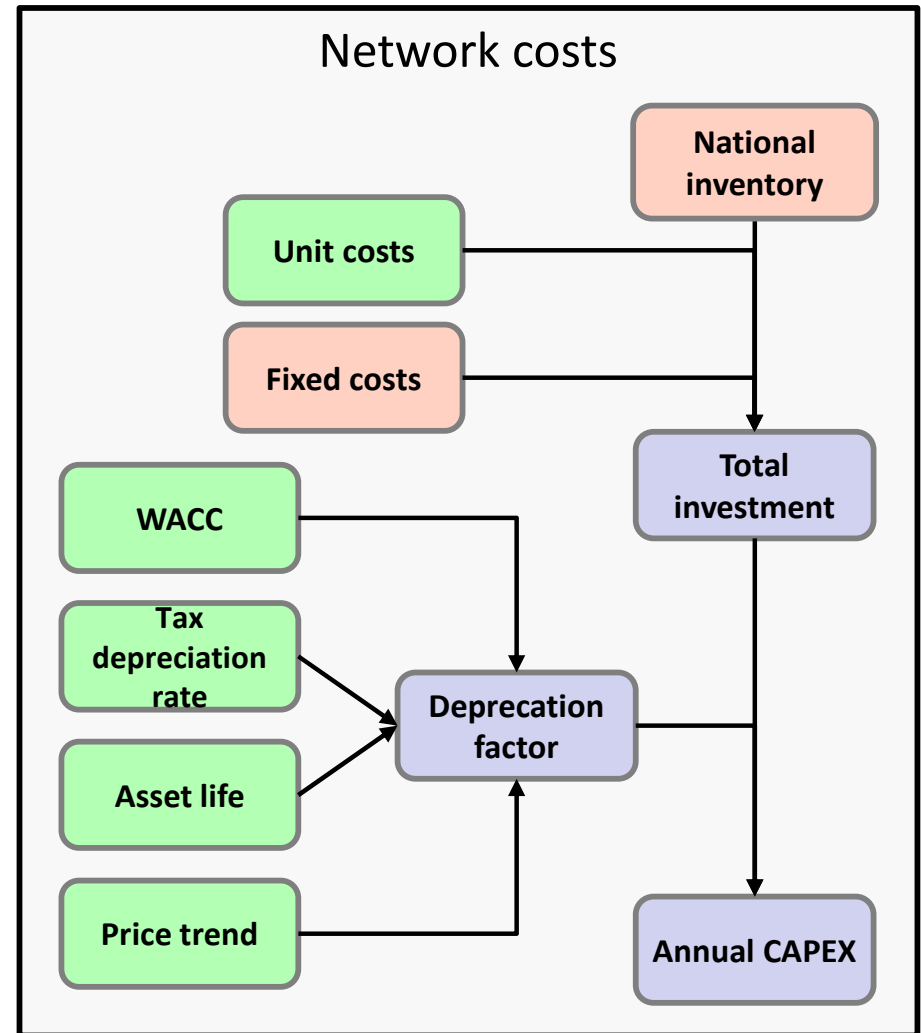

From dimensioning to pricing

Prices differentiation between UBA services

- The dimensioning of the core network is independent of the traffic:
 - *DSLAMs are dimensioned based on the number of active customers;*
 - *Switches are dimensioned based on the number of DSLAMs and number of ports set aside for interconnections (with RSP or with the REN); and*
 - *Fibre links are dimensioned based on the number of DSLAM sub-racks.*
- **The cost of providing the different UBA services is therefore the same.**
- In order to ensure price differentiation between the different UBA services and cost recovery, a gradient approach is followed.
- The mark-ups are based on the IPP prices from 5 November 2013:

Service	Mark-up
BUBA	0%
EUBA 40	21.32%
EUBA 90	26.57%
EUBA 180	36.02%



Agenda

- Context
- Main modelling assumptions
- Modelling approach
- **Model implementation and usage**

Architecture of the models

- The TSLRIC model is made of 4 main files:
 - 1 MS Access file used to dimension the passive network; and
 - 3 MS Excel used to determine:
 - OPEX;
 - CAPEX of the access network;
 - Cost of the core network and prices.

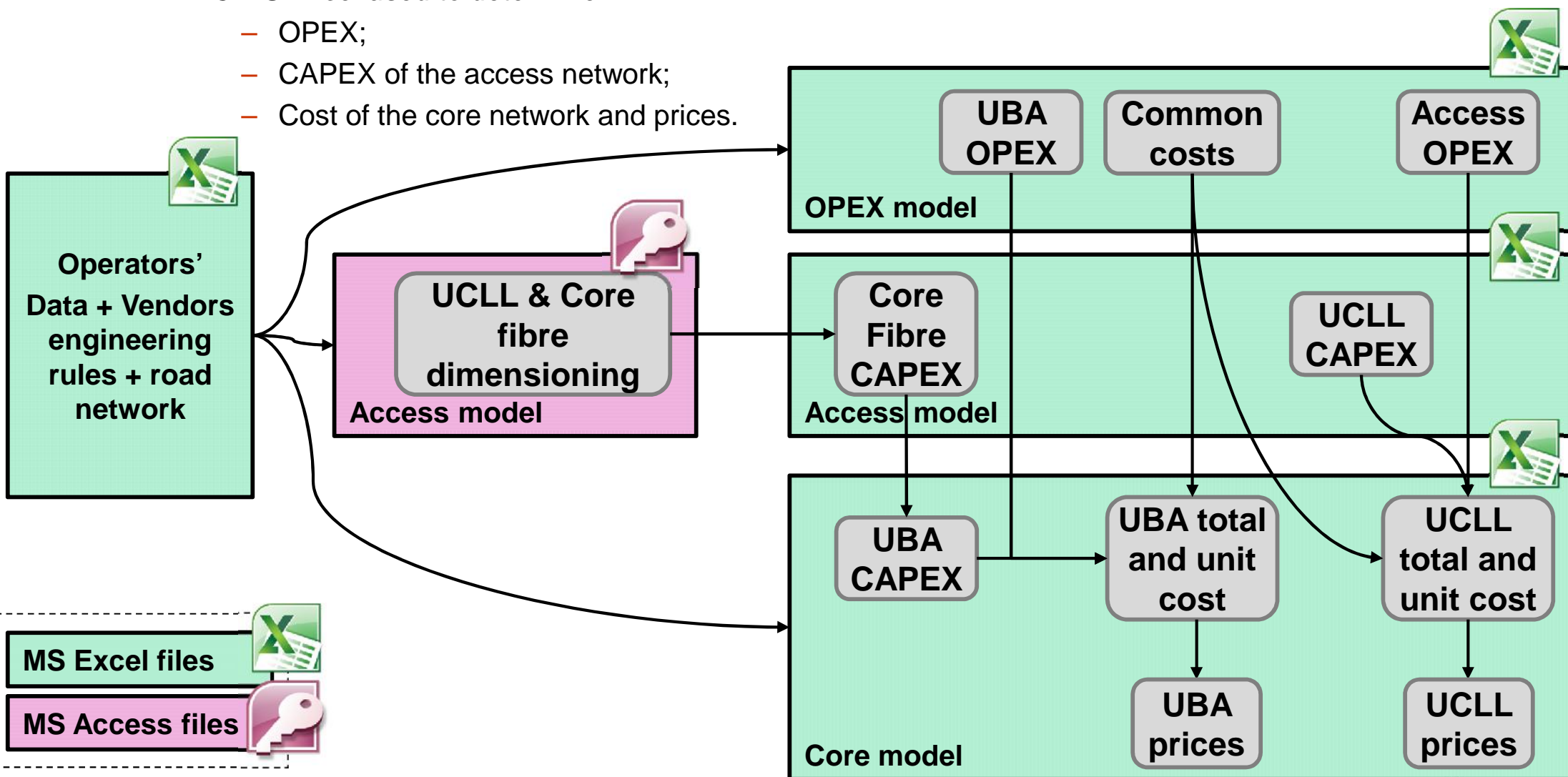

OPEX model

Overview of the OPEX model

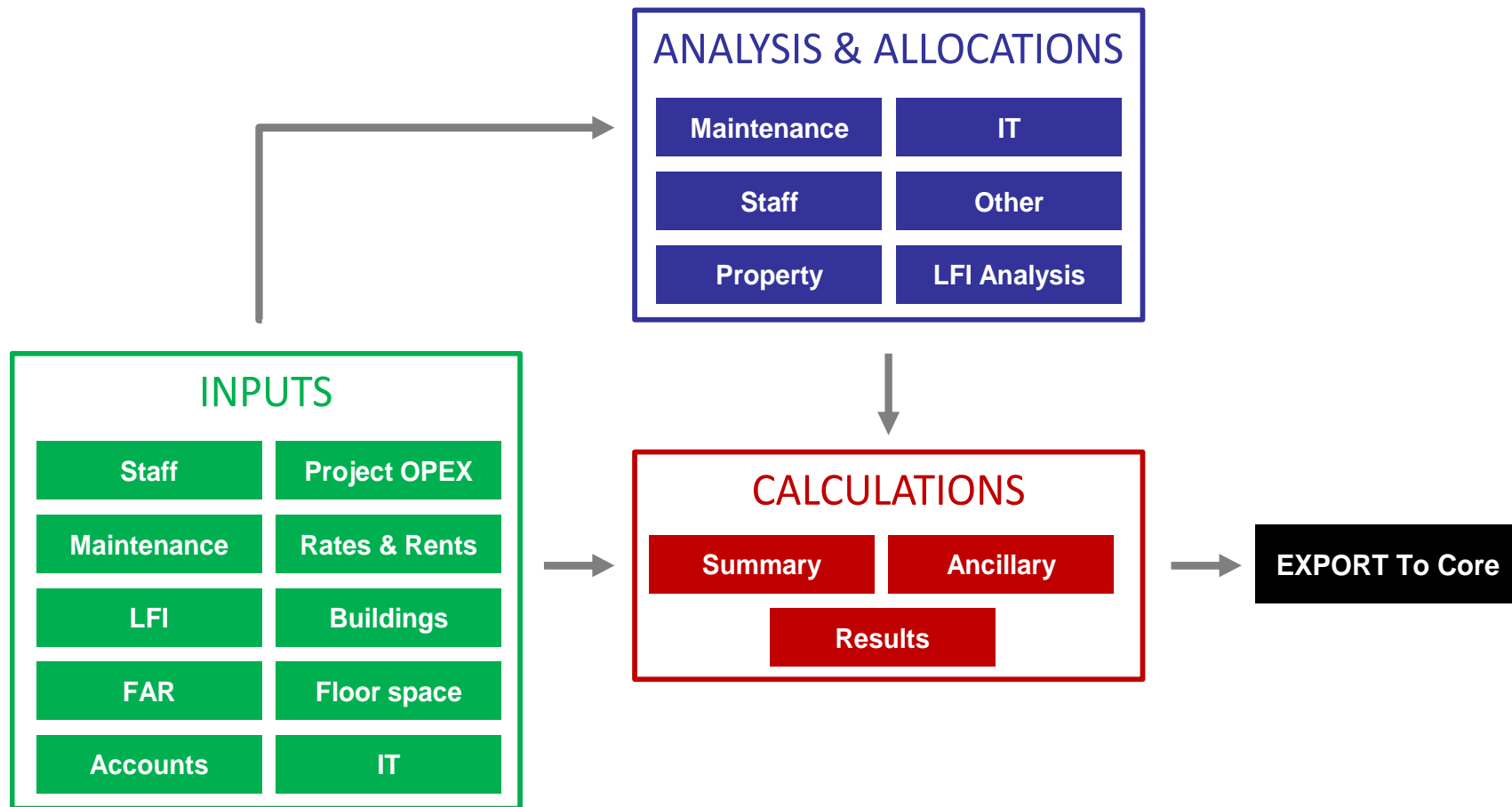

Access model

Overview of the access model (Microsoft Access)

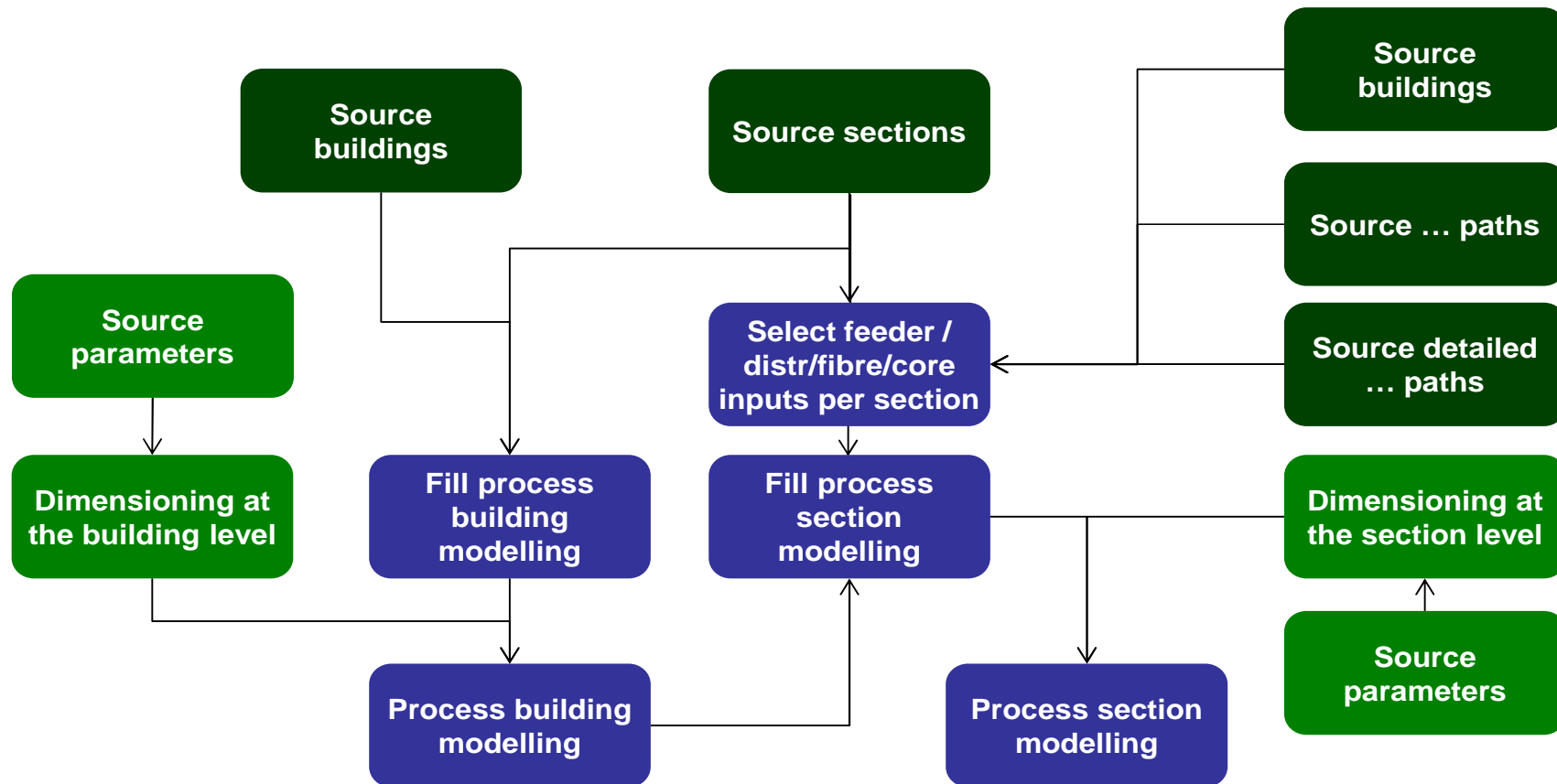

Access model

Overview of the access model (Microsoft Access)

Control

TERA CONSULTANTS

Access Network Cost Modelling
Draft version - October 2014

COMMERCE COMMISSION NEW ZEALAND

TERA Consultants - 2014

Network Modelling

Start the modelling

Modelling Parameters

General parameters

COPPER parameters

FIBRE parameters

Results

UNDERGROUND COPPER results

OVERHEAD COPPER results

UNDERGROUND FIBRE results

OVERHEAD FIBRE results

Access model

Overview of the access model (Microsoft Excel)

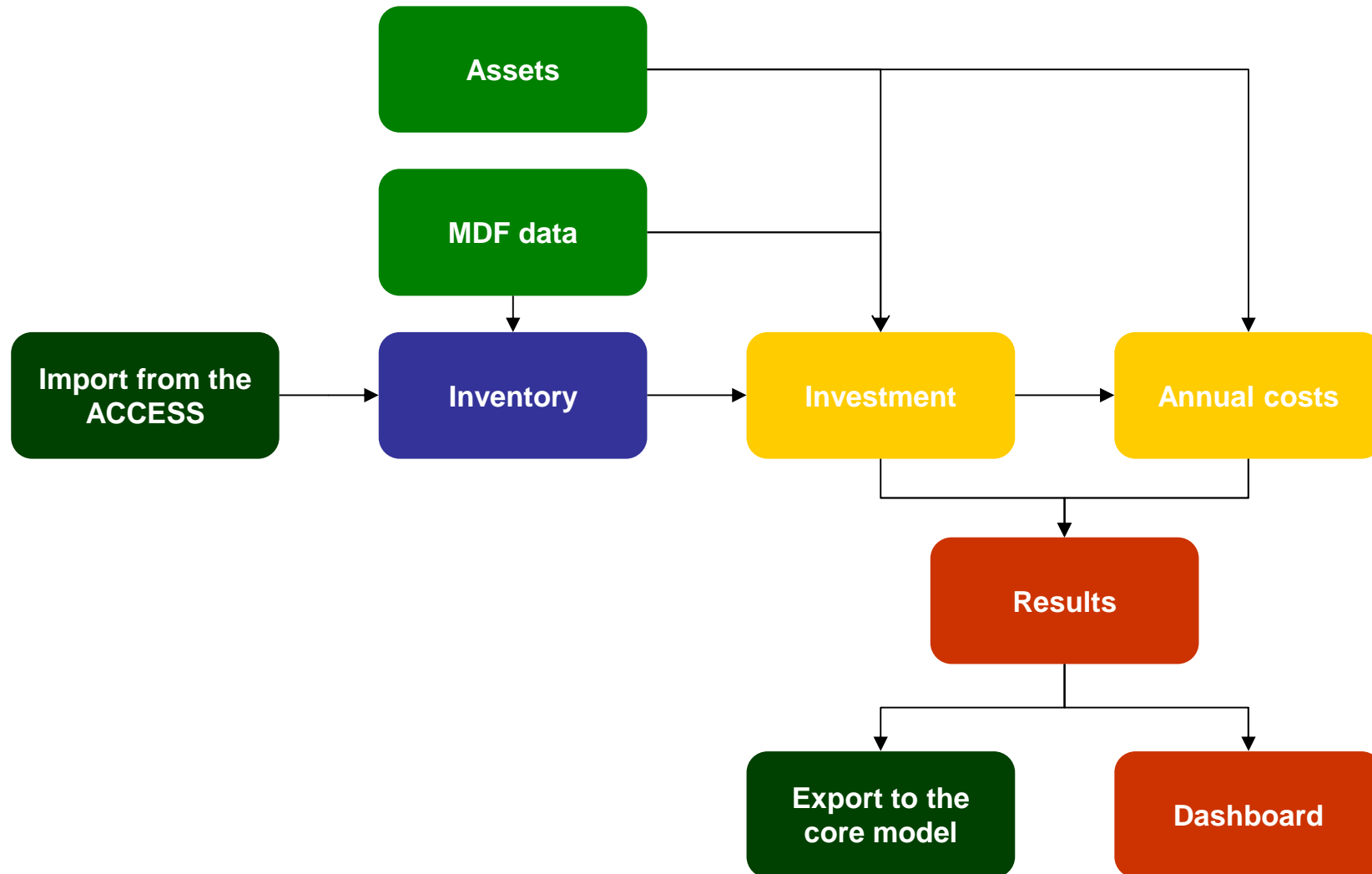

Core model

Overview of the core model

