

Net Zero Grid Pathways 1

Major Capex Project (Staged) updated

Attachment B: Power System Analysis report

Date: 25 September 2023

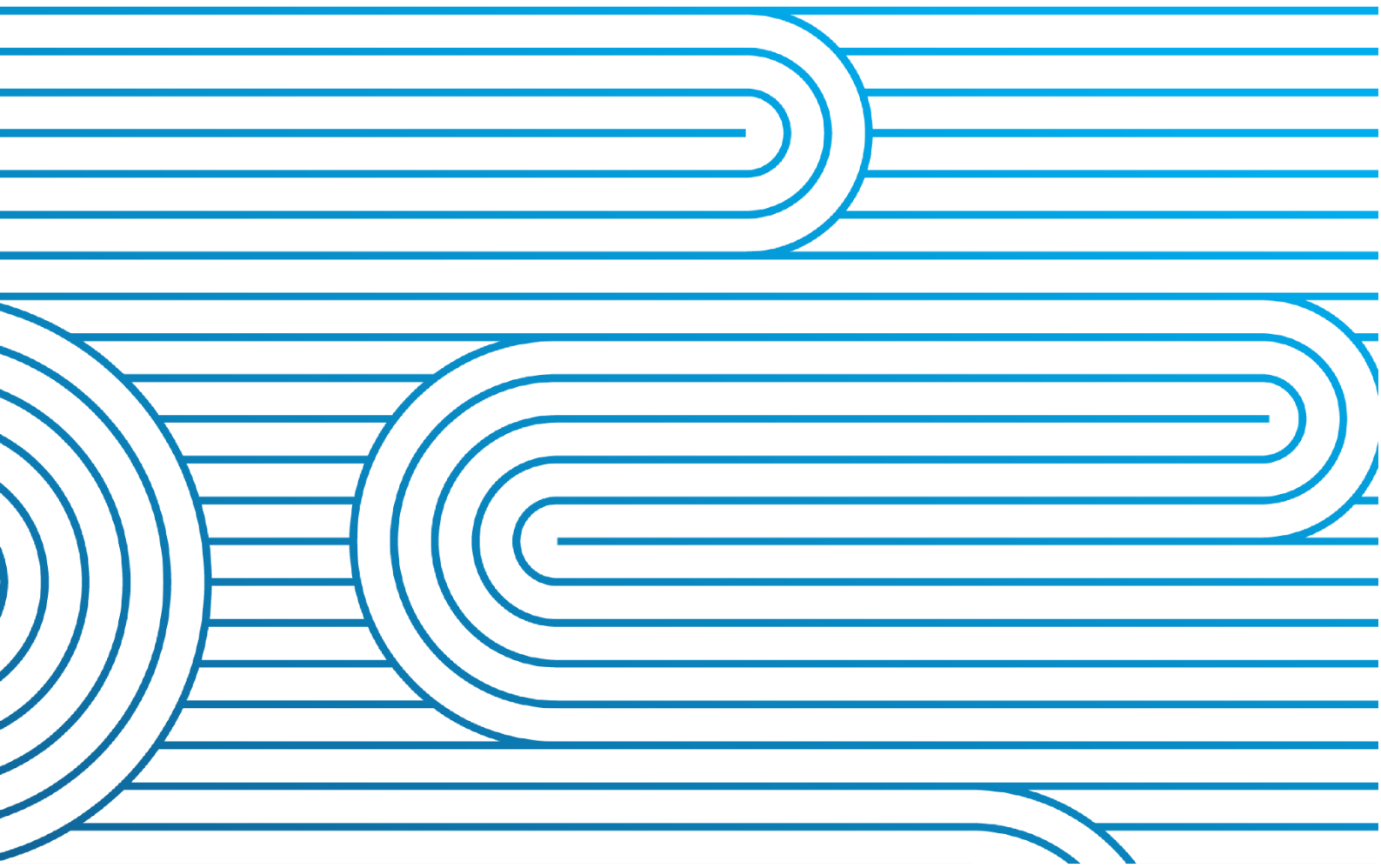

Contents

1.0 Introduction	2
1.1 Purpose.....	IV
2.0 HVDC Asset Management Plan.....	V
2.1 Asset class snapshot	VI
2.2 Asset Class Strategy.....	VI
2.3 Lifecycle – deliver, operate, maintain, decommission and disposal	VII
2.4 Asset risk – health and performance.....	IX
2.5 Forecast work and capex expenditure	XII
3.0 Reactive Assets Asset Management Plan.....	XIII
3.1 Asset Class Strategy	XIV
3.2 Lifecycle – deliver, operate, maintain, decommission and disposal	XVII
3.3 Asset risk – health and performance.....	XVII
3.4 Forecast work and capex expenditure	XVIII
3.5 Historical north transfer capability between the North and South Islands	XX
Appendix A - Central North Island Option Analysis Report	XXII
Appendix B - Wairakei Ring Option Analysis Report	LXXXI

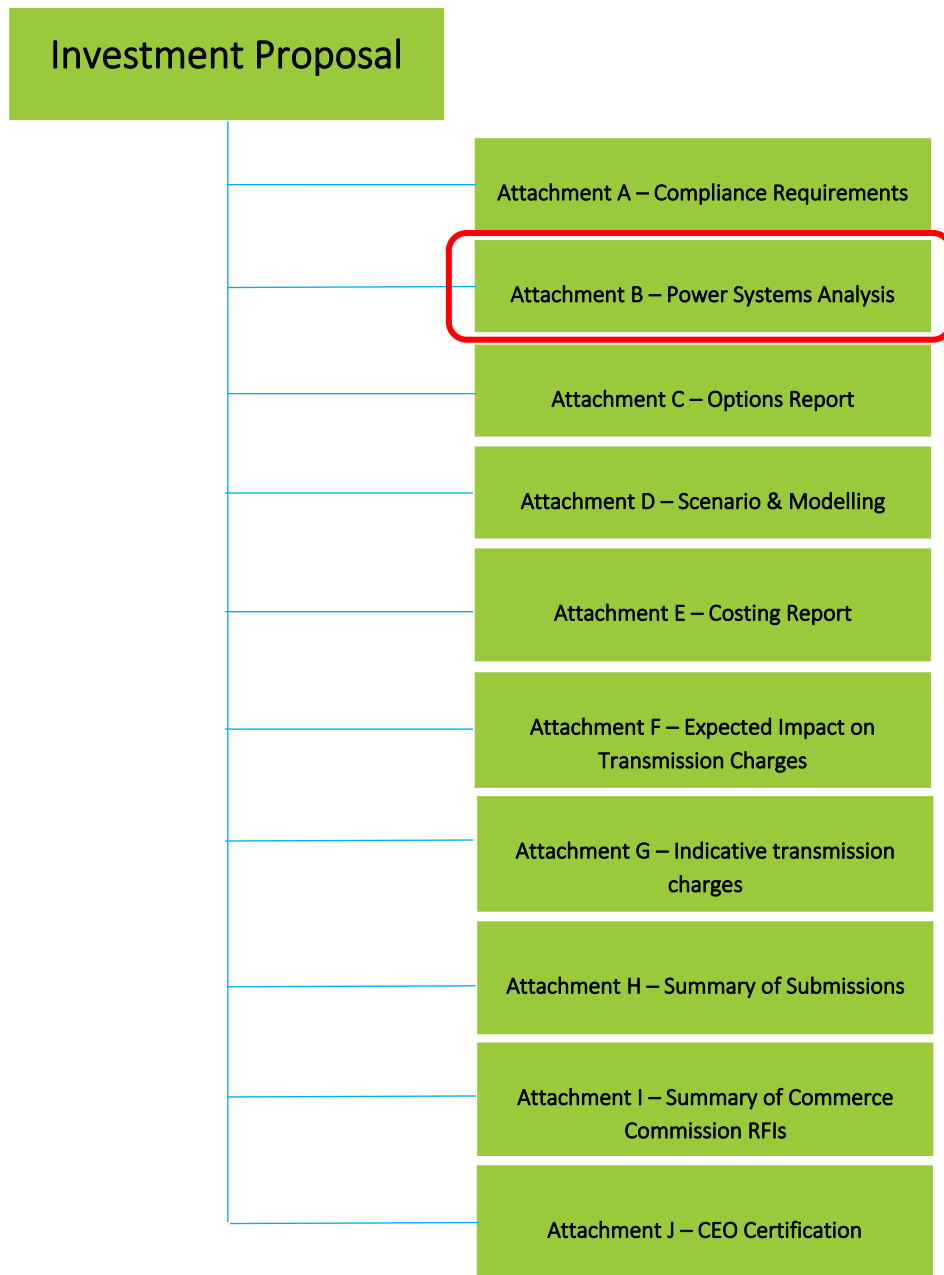

The diagram shows a hierarchical structure for an Investment Proposal. A central green box labeled 'Investment Proposal' is connected by a vertical blue line to a series of ten green boxes, each representing an attachment. A red rounded rectangle highlights the 'Attachment B – Power Systems Analysis' box.

Investment Proposal	Attachment A – Compliance Requirements
	Attachment B – Power Systems Analysis
	Attachment C – Options Report
	Attachment D – Scenario & Modelling
	Attachment E – Costing Report
	Attachment F – Expected Impact on Transmission Charges
	Attachment G – Indicative transmission charges
	Attachment H – Summary of Submissions
	Attachment I – Summary of Commerce Commission RFIs
	Attachment J – CEO Certification



1.0 Introduction

This document is the Power System Analysis report for the Net Zero Grid Pathways Stage 1 Major Capex Proposal.

This document describes the power systems analysis performed to identify the respective needs, components we considered for this project, and how these components were evaluated to determine our short-list. It also describes the HVDC asset strategy and plan. It is one of the supporting attachments for our main report (NZGP1 Major Capex Proposal) and should be read in conjunction with the main report.

1.1 Purpose

The purpose of this report is to

- Explain the HVDC asset strategy and asset management plan.
- Explain the power systems analysis and assumptions used to develop the short-list options for the Central North Island and Wairakei Ring regions.



2.0 HVDC Asset Management Plan

The HVDC system provides a high-capacity connection between the North Island and South Island electricity systems, providing energy security through the ability to access South Island renewable generation as well as enabling the operation of an efficient national electricity market. It also provides dynamic energy transfer response and frequency-keeping services that benefit the electricity market through considerably reduced frequency keeping and reserve costs. The HVDC system is expected to play a key role in compensating for intermittent renewable generation and load patterns going forward. As such the role and service criticality it plays in connecting New Zealanders will evolve along with electrification.

The HVDC system comprises of Pole 2 commissioned in 1992 and Pole 3 commissioned in 2013 with both based on thyristor valve technology. There are converter stations at Haywards and Benmore, cable stations at Fighting Bay and Oteranga Bay, electrode stations at Te Hikowhenua and Bog Roy, three submarine cables that cross the Cook Strait, and a transmission line that connects Hayward to Oteranga Bay and Fighting Bay to Benmore. HVDC converters are used for converting alternating current (AC) to direct current (DC) which is then transmitted through HVDC overhead lines and cables into the other station, where the current is converted back to AC from DC.

Electrode stations are used to inject and extract DC current to and from the remote earth. They facilitate the operation of Pole 2 and Pole 3 with unbalanced currents, or with one pole out of service. Earth return removes the need for another set of conductors between Haywards and Benmore, thus reducing the initial capital cost of the system, maintenance costs, as well as system losses by providing a low resistance current path.

Each converter station consists of many AC and DC assets with some that are unique to the HVDC systems. There are circuit breakers, voltage and current transformers, power transformers including HVDC converter transformers, thyristor valves, valve cooling systems, redundant control systems, fire protection systems, mechanical ventilation systems, LVAC and DC distribution systems, HVDC harmonic filter banks and other reactive plant, and many other substation assets.

The TransGO telecommunications network supports the HVDC protection and SCADA communications service. The planned TransGO upgrade will consider the requirements of these services and will incorporate their modernisation as part of the network refresh. The local IP Network equipment used by HVDC, and other Power Electrics systems will be lifecycle managed as part of the wider recurring lifecycle investment.

The PI suite of systems is used for monitoring the condition of the HVDC rotating assets and for analysing trends and operational data which is a key input into our forward work planning and indicating asset health.



2.1 Asset class snapshot

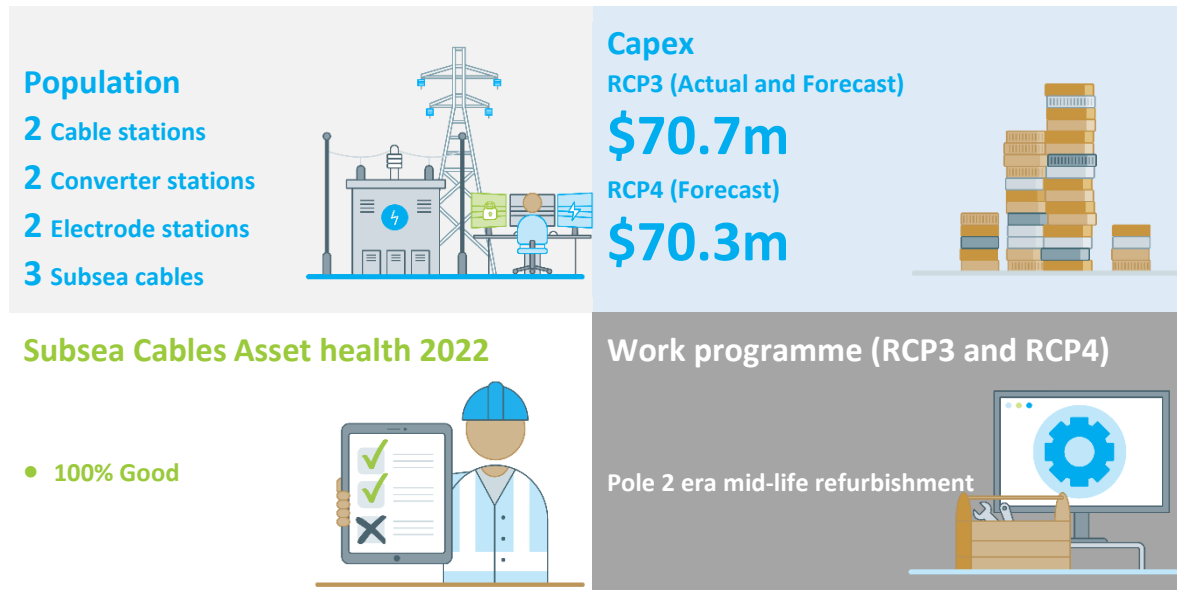

2.2 Asset Class Strategy

Objective

Our HVDC system is operated safely and reliably, at least lifecycle cost.

Measure:

Annual bi-pole availability greater than 98.75%, with a 0.7% reduction in availability for the three years that will be affected by Pole 2 life extension work in RCP3.

Asset Strategy:

- Replace and refurbish Pole 2 and 3 equipment when they reach their manufacturer's recommended operating/duty limits or reaches its expected life.
- Ensure there are sufficient plans, skilled personnel and emergency equipment in place to enable rapid restoration of HVDC transmission service following failure
- Maintain necessary resources to undertake a prompt cable 'cut and cap' operation, to reduce water ingress in the event of a submarine cable fault.

The HVDC system forms a critical part of the New Zealand transmission system. The asset components that collectively make up the HVDC system are diverse, experience different environmental operating conditions and redundancy levels, and have different expected lives. Compared to their AC counterparts, the majority of our HVDC assets have been specifically customised and designed for our operating conditions and environment. The specialist nature of the HVDC requires specialist international expertise, specifically designed assets to meet local requirements, type testing and early supplier engagement.



Our recent Net Zero Grid Pathway scenario update has shown a continuing need for HVDC capacity between the North and South Islands, with developments such as the possible Tiwai exit and Lake Onslow hydro storage scheme investigation. Our expectation is that with higher demands on HVDC capacity, the availability of outage windows for lifecycle and life extension work on the HVDC system will be materially reduced. Similarly, HVDC reliability expectations will continue to increase. Our asset planning accounts for these effects, including the phasing and packaging of the proposed work.

Our investment planning is based on achieving a 50-year operational life from each HVDC pole by undertaking necessary interventions at the correct times. Our life extension programmes will reduce the whole-of-life costs by deferring expensive pole replacement by 20 years or more. Compared to reactive interventions, the life extension work reduces the risks associated with ageing assets in poorer condition and ensures the continued service levels expected by our customers. A Pole 2 life extension programme is now underway with a significant portion delivered across RCP3 and RCP4. Our regular maintenance and other interventions supplement the life extension plans.

2.3 Lifecycle – deliver, operate, maintain, decommission and disposal

Interventions for HVDC assets are individually scoped and priced based on asset health and other factors such as safety risks and obsolescence. They are scheduled according to need and resource availability, while accounting for other work across all six sites. Many HVDC assets and systems have long lead times and can only be replaced during annual HVDC outages. The work requiring HVDC outages are planned to be delivered during the annual HVDC outage to ensure that the annual HVDC availability requirements can be met.

Delivery times for larger HVDC projects account for detailed design, procurement, availability of specialised resources, outage planning, electricity market impacts, and coordination with other major works across the HVDC link. This is typically two to three years in duration. Some projects require highly skilled specialised engineering and service provider resources which are obtained through consultants, manufacturers, and service providers from other regions. Engineering support is normally provided internally by HVDC engineers. Due to the unique nature of our HVDC assets, active participation of HVDC engineers during delivery is necessary along with good documentation and training as part of close outs. It is important to ensure that our staff are well trained to operate and maintain the new assets delivered through the project.

We generally plan HVDC outages in summer when the HVDC demand is lowest. Good planning and preparation is required and is undertaken with the industry to ensure HVDC work can be completed without major system impacts.

Regular condition assessments of our HVDC assets are undertaken in accordance with technical specifications. There are online-monitoring systems which enable us to monitor the condition of HVDC assets in near real time. There are several interval-based visual inspections. Table 1 outlines the condition assessments we undertake for HVDC equipment.



Most HVDC assets require special maintenance tasks prescribed by original equipment manufacturers. We also seek feedback from the international HVDC operator community. This information is reflected in our standard maintenance procedures. The majority of the HVDC maintenance work is carried out during the annual maintenance outage.

The maintenance of the HVDC line is covered under Transmission Lines portfolios. In general, HVDC assets require less opex, other than routine maintenance and some predictive maintenance works. The system criticality of the HVDC system demands a highly reliable HVDC system. Replacements, refurbishments and more frequent routine maintenance generally address these requirements.

Our maintenance activities for the HVDC system include activities such as:

- corrosion and defect repairs on primary equipment (i.e., maintenance of converter transformer tap changers, cooling fans, motors, etc.)
- land and shore electrode maintenance
- building maintenance activities such as roof, air conditioning and guttering repairs
- replacement or refurbishment of consumables and high-wear components and parts
- cleaning and water blasting of insulating material.

Table 1: HVDC condition monitoring and tests

Asset type	Measured condition parameters
Majority of HVDC assets	Visual inspections
	Unscheduled UV/Corona camera inspections
	Thermographic checks
Transformers including converter transformers	Dissolved Gas Analysis (DGA) – continuous online monitors and laboratory tests
	Tap changer operations count readings
	Electrical testing such as insulation resistance, power factor, polarisation index and capacitance test
	Unscheduled furans testing
Pole 3 Buildings	Seismic event and deflection monitoring at Haywards – checked after significant seismic events
Converter stations	Thyristor diagnostic inspections in line with manufacturers requirements + continuous monitoring by the control system
	Monitoring of water conductivity, electrode inspections, flow rates and pressure in valve cooling systems
	Secondary and auxiliary equipment monitoring such as self-check systems
Thyristor stack	Visual inspection of thyristor stacks
Filter bank circuit breakers	Circuit breaker operations count readings
	SF ₆ gas pressure and quality – readings, quality checks, and low-pressure alarms



Asset type	Measured condition parameters
	Electrical testing such as insulation resistance and contact resistance tests
	Velocity plot – includes measuring timing of main contacts, closing/opening speeds and closing/opening damping tests
Cable stations	Bushing gas analysis
	Hydrophobicity testing of bushings
	Internal bushing gas pressure readings
Submarine cables	Line Resonance Analysis (LIRA)
	Dive spot checks and surveys
	Remotely operated vehicle surveys and checks
Shore electrodes (THW)	Current sharing tests and resistance measurements
	Lift and clean electrodes of salt deposits
Land electrodes (BGR)	Current sharing tests and resistance measurements
	Resistance measurements

Where possible and useful, we donate retired equipment to education institutions. We recycle as much of the equipment as possible. The three legacy Cook Strait submarine cables installed in 1965 that are no longer used have been left in place as the costs and risks of recovery outweigh any benefit from recycling. There are no significant environmental effects from the old cables remaining in place.

2.4 Asset risk – health and performance

HVDC assets that fit within our wider asset classes such as the HVDC line, circuit breakers, instrument transformers, power transformers and filter banks are included within those existing asset health models. For example, health modelling for HVDC circuit breakers is included within the health model for AC outdoor circuit breakers.

Table 2 provides a view of remaining life by major system component below.

Most Pole 3 assets are still in relatively good condition.

The expected end of life of the subsea cables is 2032. We have developed an asset health model for HVDC cables incorporating ageing calculations, annual inspection results and test results to estimate the remaining life of the submarine cables. As also shown below, our asset health modelling indicates that the cables are in good condition. However, deterioration could accelerate due to localised environmental and operational factors leading to shorter life expectancies. Hence a cable section in poor condition or a deep-sea cable fault with a complex repair could dictate the end of life of a cable. Depending on their condition, this may also influence the replacement of other remaining cables as all cables operate in a similar environment. There are also significant synergies in replacing the cables as a single campaign due to manufacturing, transport, and installation costs.

The design, manufacture and installation of new submarine cables has a long lead time of around five years. The reactive replacement of the cables is a significant risk as concurrent cable failures



would constrain the interisland capacity for an extended period. Hence planned replacements informed by the asset health models is important to ensure high HVDC availability.

Cable stations require ongoing refurbishment work to ensure their reliable operation until a major upgrade associated with cable replacement occurs.

Electrode stations and related assets are in good condition. Due to their dynamic operating environment, asset health modelling is not practical for HVDC electrodes. Factors such as electrode line current, direction of the HVDC flow, resistivity of the surrounding area, and weather events affect the degradation of electrodes.

Degradation of the electrodes can also be very localised. Hence two-yearly current and resistance measurements and weighing of the electrodes is the appropriate approach for managing these assets.

Table 2: HVDC major component life expectancy

Major system component HVDC	Year commissioned	Life expectancy	Planned refurbishment	Expected end of life
HVDC Pole 2 converter stations	1992	50	~ RCP 3	2042
HVDC Pole 3 converter stations	2013	50	~ RCP 6	2063
Subsea Cable 4	1992	40	N/A	2032
Subsea Cable 5	1992	40	N/A	2032
Subsea Cable 6	1992	40	N/A	2032

Figure 1 shows the current health of our HVDC subsea cables.

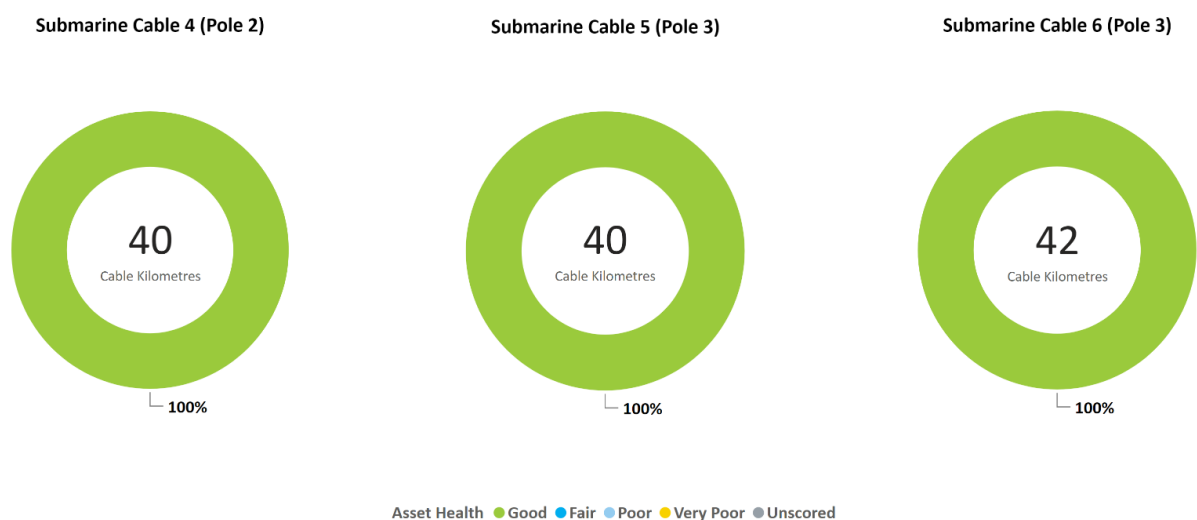

Figure 1: HVDC cable current asset health



Our HVDC Converter Station consolidated simplified bow-tie as shown in Figure 2 informs us of the most likely causes of failure, along with the most likely resulting consequences of the failure.

The predominant causes for HVDC system failures are functional failures such as control system issues or auxiliary system failures, overheating, corrosion and material degradation, electrical failures such as insulation failures, mechanical failures, third-party activity close to assets, pests and vermin damage, and natural causes. The key preventative controls implemented to reduce the likelihood of failure event includes redundancy, lifecycle planning, monitoring inspections and testing, quality assurance during the original installation, procurement specifications, maintenance activities and staff and contractor competency management. Media and stakeholder engagement and regular patrolling of the cable protection zone are critical controls for managing the risk to Cook Strait submarine cables. The availability of the HVDC link varies from year to year, due to the number and length of planned and forced outages. Overall, the HVDC link has achieved world-class levels of availability since it was commissioned. Figure 3 shows the annual availability of the HVDC link since 2015. The reduced availability across 2019/20 is due to HVDC line reconductoring during February 2020.

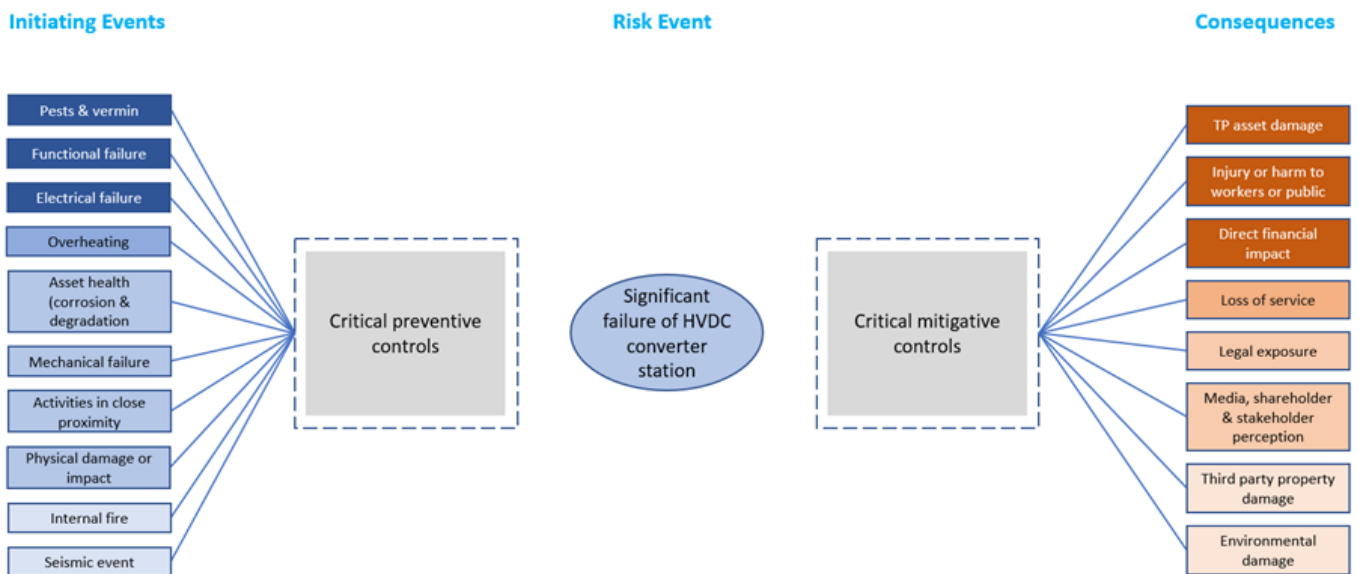

Figure 2: HVDC Risk Bowtie



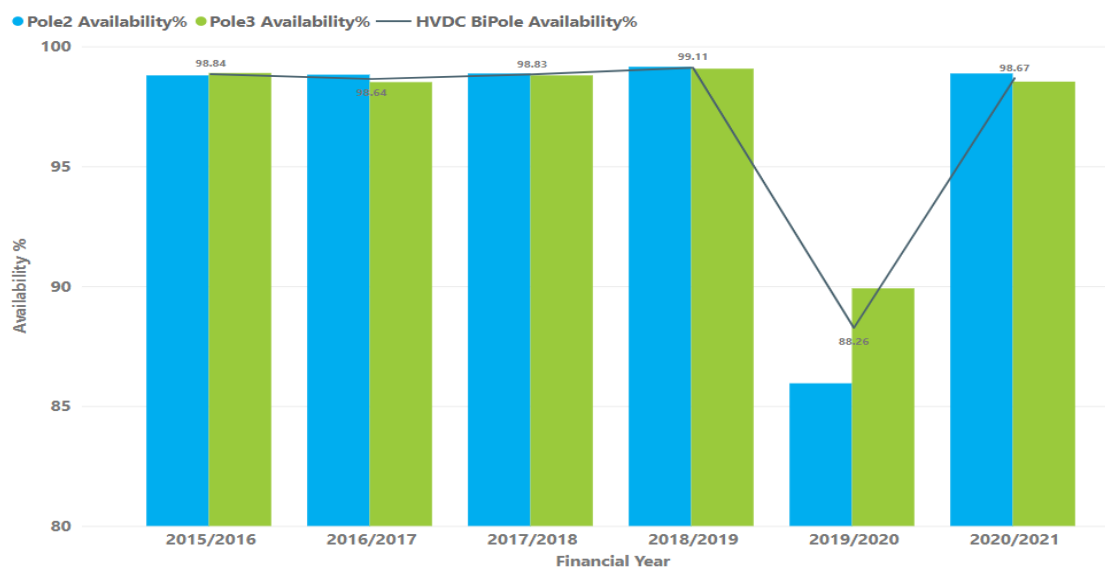

Figure 3: HVDC performance

Pole 2 life extension work aims to maintain the high availability target of 98.75% going forward into RCP4 and beyond. Without this life extension work, the probability of forced outages per annum exceeding the 0.25% target would increase significantly with the ageing of Pole 2 era assets. This life extension work will also defer the more costly replacement of Pole 2.

2.5 Forecast work and capex expenditure

Opex: The majority of the opex forecast covers HVDC cable surveillance and operational support. General testing and maintenance requirements associated with AC assets also apply to many HVDC assets. Refurbishments and major interventions on most HVDC assets are not feasible or cost effective. A failure of the HVDC system will affect the entire network rather than a small region or a site. Similarly, there is only one annual outage which is used for maintenance and capex work. Therefore, replacements are often necessary to maintain the required level of availability and reliability.

Opex projects such as investigation projects, condition assessments, refurbishment of tap changers and reactors are planned for condition improvement of assets. The opex expenditure is covered in detail in the Maintenance Asset Class Plan.

Capex: RCP3 expenditure covers the converter transformers refurbishment programme; replacement and refurbishment of HVDC primary assets, including the wall bushings and primary measuring equipment; refurbishing secondary and auxiliary systems; improving seismic performance of HVDC buildings; and refurbishing the HVDC station services supply. The impact of the COVID-19 pandemic and the increased cost of procuring specialist HVDC plant has led to additional expenditure beyond what we have estimated in our RCP3 submission. We have prioritised our RCP3 workplan following detailed condition assessments undertaken in 2020. This



has allowed us to defer less urgent interventions in to RCP4 to minimise the impact on our RCP3 allowance for the HVDC portfolio without incurring additional risk.

A significant portion of the Pole 2 life extension programme is planned to be delivered across RCP3 and RCP4. In RCP3, the delivery of the Pole 2 life extension programme will affect the HVDC availability due to longer outages required for commissioning the refurbished converter transformers and other primary asset replacements. RCP3 availability targets approved by the Commerce Commission accommodate a 0.7% additional allowance for three years for the delivery of major Pole 2 life extension works.

The replacement of the remainder of Pole 2 era primary AC assets such as interventions to reactive support plant, addressing obsolescence issues, refurbishment of remaining auxiliary systems, interventions to cable station primary and secondary assets, interventions to some Pole 3 era assets and systems such as the communication and fire systems are planned for RCP4.

As Pole 2 interventions revert to routine minor work following the life extension programme, major interventions to Pole 3 era assets and secondary systems will commence in RCP5 and will continue across RCP6. This includes the likely HVDC control system replacement in RCP5 which is a significant undertaking.

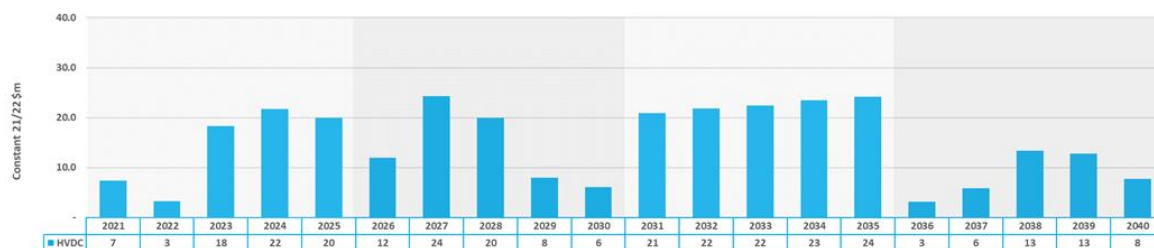

Figure 4: HVDC forecast capex and quantities

3.0 Reactive Assets Asset Management Plan

Our reactive assets incorporate:

- Synchronous condensers
- Static Var Compensators (SVCs) and Static Synchronous Compensators (STATCOMs), including those located at the HVDC converter stations



- Capacitor banks and reactors excluding those located at the HVDC converter stations

We use switched capacitor banks and reactors to provide most of the reactive power support required for the network. To ensure stability under transient or abnormal conditions, the system also requires fast-acting sources of dynamic reactive power. This is provided by the synchronous condensers, SVCs, and STATCOMs.

3.1 Asset Class Strategy

Objective

Safe and reliable operation, at least whole-of-life cost.

Measures:

- Less than ten unplanned outages per annum caused by capacitor banks and their components at lowest lifecycle cost.
- 98 percent or better availability of SVCs and STATCOMs and less than three forced and fault outages each year from each SVC or STATCOM.
- Average annual availability greater than 96.0 percent for each Haywards synchronous condensers including planned unavailability of 3.5 percent or less and unplanned unavailability of 0.5 percent or less.
- Less than two unplanned outages and two planned outages for each synchronous condenser each year.

Asset Strategy:

- Replace capacitor banks and reactors when they satisfy replacement criteria and refurbish capacitor banks and reactors to extend their lives where they are not replaced.
- Undertake half-life refurbishments on SVCs and STATCOMs (typically 20 years) to ensure that the main plant can achieve reliable operation until the end of its engineering life.
- Undertake major overhauls to extend the life of the synchronous condenser main units, typically at 15–20-year intervals, or based on condition.

The population and age profile of our reactive assets are shown in Figure 5

Investment need is primarily based on addressing capacitor can failures on ageing and deteriorating capacitor banks, addressing obsolescence and high risk of failure due to ageing of control systems, improving synchronous condenser availability as well as minimising the risk of failures, addressing control and auxiliary system assets reaching end-of-life, and undertaking life extension work on reactors.

The portfolio is arranged round the provision of reactive support to the network rather than a single asset type. As well as the portfolio specific assets (e.g., synchronous condenser machines), there are many other components within the reactive device that are the same as those in other portfolios. For these items we follow the strategies and maintenance methods of the main portfolio.



We consider, however, replacement of whole reactive devices when planning major works on individual assets to ensure that we balance the overall continuing need for the plant. This includes costs for partial replacement and the increased maintenance costs towards end of life with the capital cost for a complete replacement of the whole plant.

The forecast greater reliance on grid infrastructure with electrification increases the need for reliable reactive equipment. To support voltage stability, reactive power controllers to manage these assets, power quality monitoring and maintaining voltage within the Electricity Industry Participation Code requirements. SCADA ensures this equipment can be monitored, data retrieved, controlled and managed by the System Operator.

The PI suite of systems is used for monitoring the assets, including the health of the capacitor banks and our telecommunications equipment such as switches and terminal servers for the SVCs and STATCOM assets.



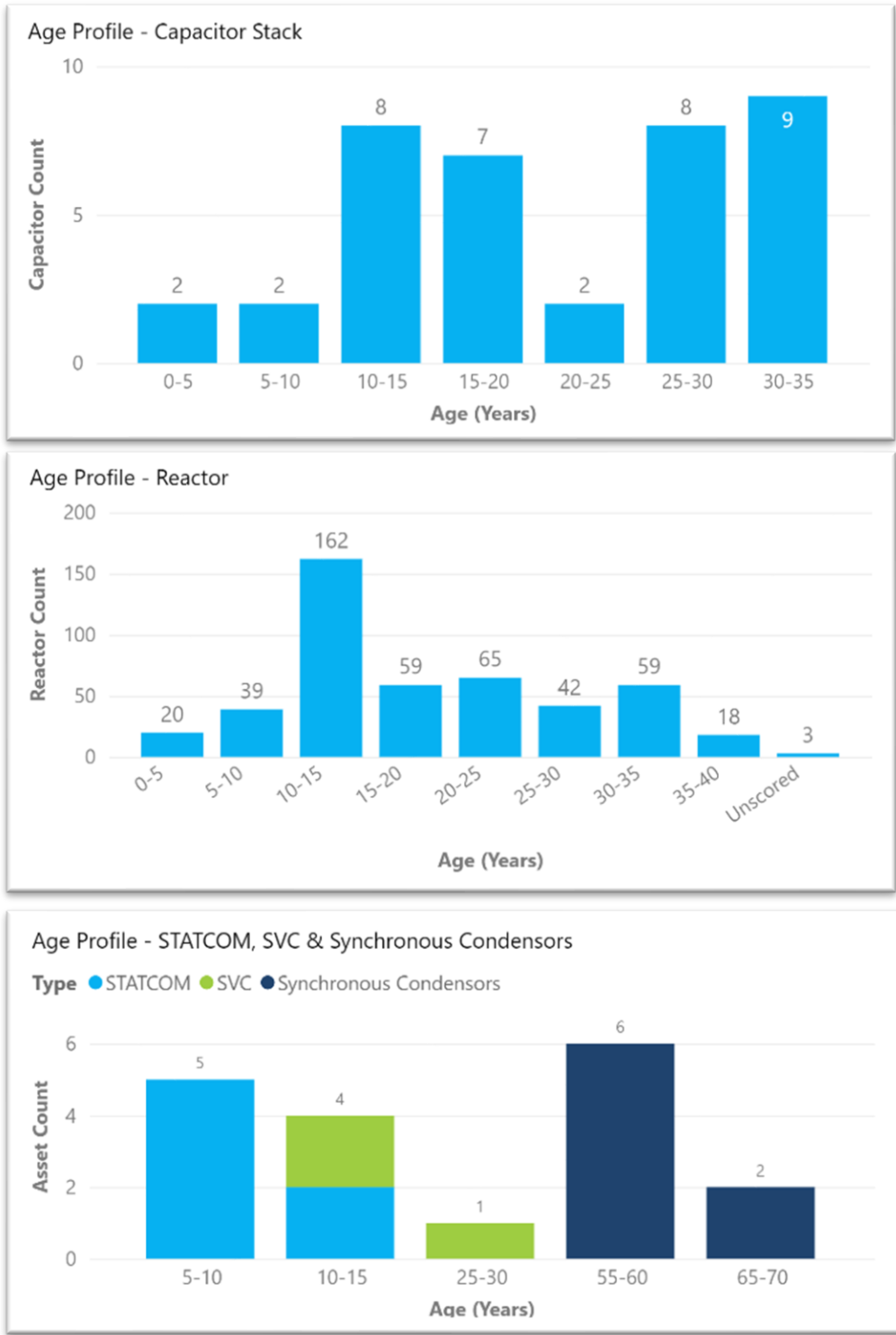

Figure 5: Reactive assets population and age profiles



3.2 Lifecycle – deliver, operate, maintain, decommission and disposal

Delivery times for reactive power assets include allowance for detailed design, procurement, outage planning, and coordination with other major works at the site. It typically takes one to two years to complete this work and can be much longer (five-plus years) for larger programmes.

We plan and manage outages in a way that creates a safe environment for employees while minimising the disruption for customers.

Dynamic reactive power assets require specialised maintenance to be carried out during the warranty period. These requirements along with operation experience during the warranty period form the basis of standard maintenance practices following the warranty period.

We have online monitoring systems that monitor the condition of key assets in real time. We also undertake visual inspections and thermo-vision inspections for early detection of potential issues.

Synchronous condenser condition assessments include visual and thermal inspections as well as electrical, mechanical and gas tests, and yearly, two-yearly and four-yearly equipment services. We have installed several smart monitoring systems to continuously monitor the condition of the synchronous condensers. We carry out internal inspections of the synchronous condensers four-yearly to ensure reliable operation by identifying issues in advance.

Capacitors and reactors have four-yearly electrical testing and inspections to monitor signs of corrosion, paint peeling, leaks, or physical deformation. These issues are addressed as part of our maintenance activities.

For most of our STATCOM installations, condition assessment is still carried out as part of the warranty reporting process. More detailed service specifications and standard maintenance procedures for SVCs and STATCOMs are planned to be developed to reflect what we have learned about these relatively new assets and the inspections completed to date.

Disposal of used capacitor cans and other oil-filled assets follow our standard protocols.

3.3 Asset risk – health and performance

Figure 6 and Figure 7 show the current health of our reactive capacitors and synchronous condensers.



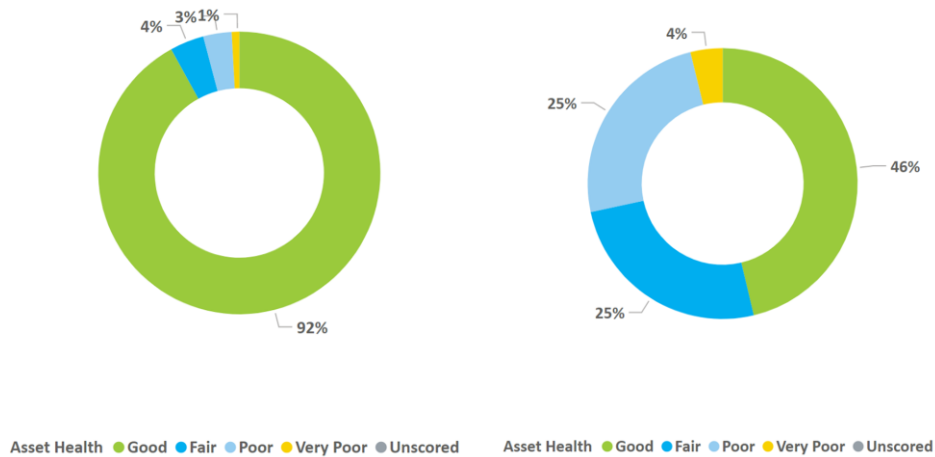

Figure 6: Reactor and capacitor current asset health

The predominant causes for reactive asset failure are:

- corrosion and degradation of electrical insulation, protective paintwork, hydrogen pipe work, hydraulic systems, auxiliary system components, seals, and connections leading to a loss of service.
- mechanical failures of components such as rotors, motors, cooling systems, racks, reactors, switches, etc. causing loss of service.
- electrical failures such as insulation degradation due to ageing or overloading, failure of electrical components, or electrical faults leading to loss of service.
- functional failure such as software failure, malfunctioning, configuration issues of control system software and/or auxiliary systems that could lead to major failures depending on the failure mode.

The combined likelihood of electrical, mechanical and functional failure increases relative to the age and condition of the asset.

The key preventive controls critical to reducing the likelihood of a failure event are:

- routine inspection, maintenance, testing, and treatment
- operating environment and temperature control
- alarms and monitoring.

3.4 Forecast work and capex expenditure

Figure 8 shows the capex forecast.

A number of the oldest capacitor banks are at end of life and will require replacement in RCP4.

We are planning to perform major refurbishments on the synchronous condensers between 2025 and 2030. It will then be ~20 years since the last major refurbishment occurred. This work is supported by the associated health model and is to ensure that these units remain operational until 2042.



The scope of these interventions is difficult to fully assess while the synchronous condensers remain in operation. To manage this risk, we are performing an invasive scoping investigation during RCP3 to better understand the scope of the refurbishment work.

At present, the resulting reduction in possible HVDC transfer caused by the Haywards synchronous condensers do not have a material impact on the operation of the electricity market. However, the future generation mix and accelerated electrification will increase the requirements for HVDC availability and increased availability of the synchronous condensers.

We have been progressing on the midlife refurbishments of the SVCs assets during RCP3 and we are expecting to refurbish the third SVC during RCP4.

There are only a small number of qualified suppliers of dynamic reactive equipment. We are seeing that as the worldwide demand for reactive equipment varies, the price for equipment can vary more than would be expected from normal economic changes with time. This will likely lift the cost of asset investments, replacements and components, as well as increasing the lead time.

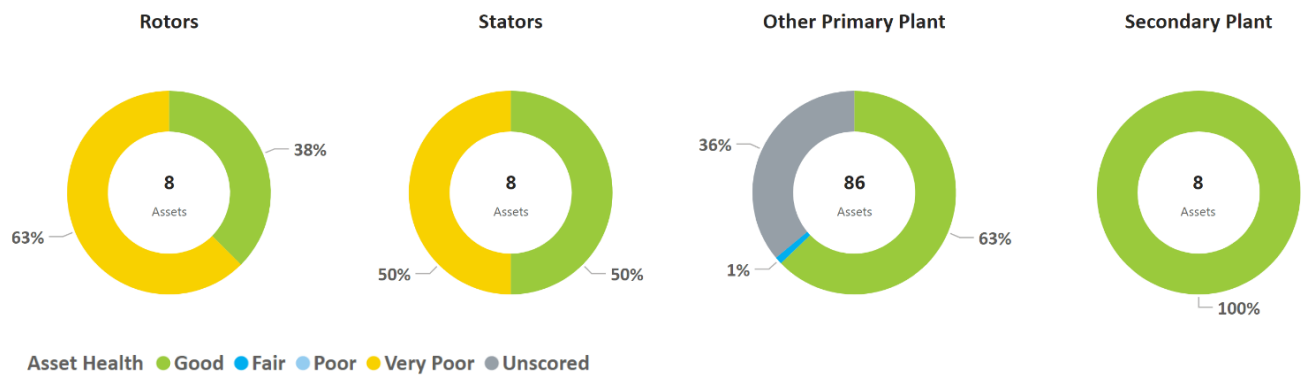

Figure 7: Synchronous condenser current asset health

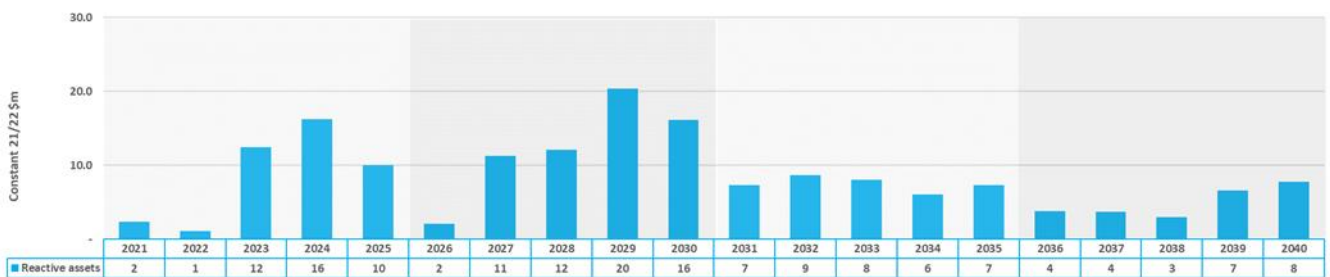

Figure 8: Reactive assets forecast capex and quantities



3.5 Historical north transfer capability between the North and South Islands

Recognising the effect that other assets, particularly at Haywards and other parts of the lower North Island network play on the availability of north transfer capability between the North and South Islands, we analysed the historic transfer capability, consistent with how the System Operator assesses transfer capability for dispatch purposes.

North transfer capability between the North and South Island can be affected by several external (to the HVDC converters themselves) factors:

- HVDC converter availability
- Synchronous condenser availability
- STATCOM availability
- Filter bank availability
- Lower North Island AC grid availability
- Wellington load

We found that the average HVDC transfer capability has been 1071 MW from 2017 to early 2022.

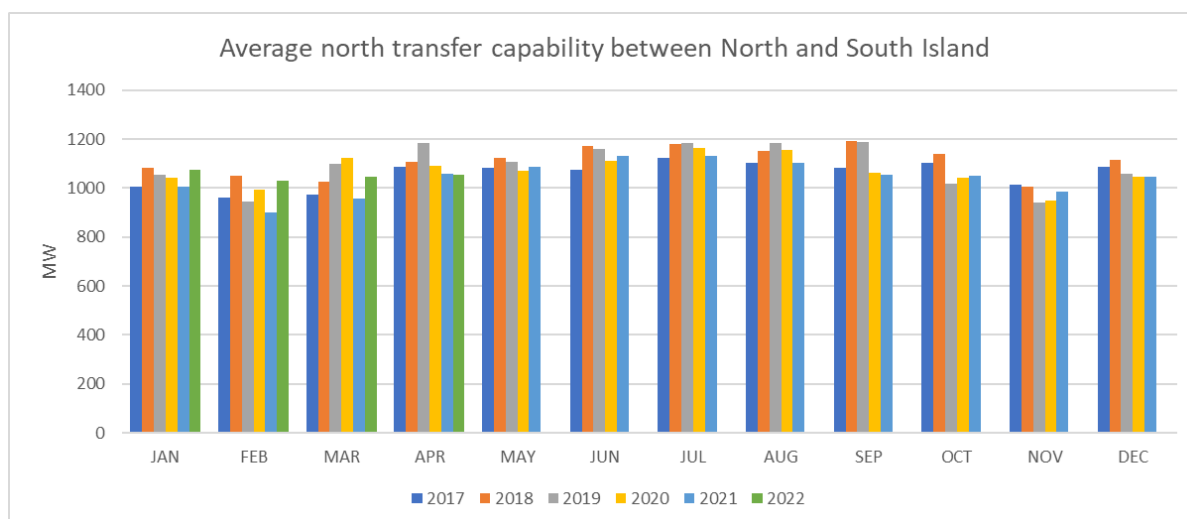

Figure 9: Average north transfer capability between North and South Island

NZGP has identified that the role of the HVDC is evolving as the New Zealand electricity system transitions from containing a significant amount of coal and gas-powered generation, to highly renewable generation.

When it was built, the purpose of the HVDC was to transfer bulk electricity generated from South Island hydro to the North Island. The electricity market did not exist at the time, and it was less important when the transfers occurred.

In the future, we expect the upper North Island to be dominated by wind, solar and geothermal generation, which is intermittent. The wind generation can only generate electricity when the wind is blowing and the solar generation when the sun is shining. Such an electricity system



requires “firming generation” to balance the intermittent generation – generation which can ramp and down quickly to ensure electricity demand is met on a real-time basis, even though generation from the wind and sun are fluctuating. Our modelling suggests that South Island hydro generation will play an important role in firming North Island intermittent generation in the future. It meets the criteria to be able to ramp up and down quickly and when there is a reasonable amount of water available in South Island storage lakes, it will also be available.

This latter point is also important. In dry hydrological years, the South Island is expected to be net short of electricity and flows over the grid would be expected to predominantly be from the North Island to the South Island for periods of time.

These requirements mean that the availability of transfer capability between the North and South islands will become increasingly important to the reliability of electricity supply in New Zealand.

Given the effect of external factors on transfer capability between the North and South islands, we interrogated the historical transfer capability and found that by far the largest contributor to reductions from the HVDC converter capacity, is synchronous condenser availability. The equipment at Haywards consists of large rotating machines. They perform a critical role, but as they age, require more maintenance and are out of service during that maintenance. North transfer capability of 1200 MW is only available when all of the synchronous condensers are in service. There are deductions from 1200 MW, depending upon the size of condenser. Similarly with the filter banks. There are deductions from 1200 MW if any of the filter banks are out of service.

Investigations found that the extra reactive support required to support a fourth Cook Strait cable (and boost HVDC capacity to 1400 MW) can be provided by a STATCOM and that the STATCOM will also provide redundancy in the event that a synchronous condenser is out of service at Haywards, i.e. if one synchronous condenser (or the other STATCOM) is out of service, there will be no deductions from 1200 MW once the new STATCOM is in place.

For that reason, our Stage 1 HVDC proposal includes the installation of a new STATCOM at Haywards and a new set of filter banks at Haywards. This equipment is all required to support a fourth Cook Strait cable and 1400 MW of HVDC north transfer, but by installing it now, we are effectively boosting the north HVDC transfer capability from 1071 MW to close to 1200 MW.

We are also proposing to improve the bus arrangement at Haywards in our Stage 1 works. This is required to connect the proposed STATCOM and Filter bank to the 220kV Bus system at Haywards and to permit Bus maintenance to be undertaken without incurring a significant decrease in the transfer capability.



Appendix A - Central North Island Option Analysis Report

Central North Island Option Analysis

COPYRIGHT © 2023 TRANSPower NEW ZEALAND LIMITED. ALL RIGHTS RESERVED

This document is protected by copyright vested in Transpower New Zealand Limited (“Transpower”). No part of the document may be reproduced or transmitted in any form by any means including, without limitation, electronic, photocopying, recording or otherwise, without the prior written permission of Transpower. No information embodied in the documents which is not already in the public domain shall be communicated in any manner whatsoever to any third party without the prior written consent of Transpower. Any breach of the above obligations may be restrained by legal proceedings seeking remedies including injunctions, damages and costs.

LIMITATION OF LIABILITY/DISCLAIMER OF WARRANTY

This document is produced for internal use only and has not been approved for external release. Its conclusions are based on the information currently available to Transpower and may change as further information becomes available either internally or externally.



Table of contents

Executive Summary	25
1	Purpose of this document.....29
2	Background.....29
3	Methodology and assumptions.....32
3.1 Analysis method	32
3.2 Study assumptions	33
4	Analysis results - short term options.....34
4.1 Option 1 and 2.....	35
4.2 Option 3 and 4.....	39
4.3 Option 5.....	40
4.4 Option 6.....	41
4.5 Option 7.....	43
4.6 Option 8.....	44
4.7 Option 9.....	44
4.8 Preferred upgrades	45
5	Analysis results - long term options.....46
5.1 Option 10 and 11.....	47
5.2 Option 12 and 13.....	48
5.3 Option 14.....	49
5.4 Option 15.....	51
5.5 Option 16.....	52
5.6 Option 17, 18 and 19.....	54
6	Additional analysis and sensitivity studies
6.1 Incremental upgrades - Duplex GoatAC 120°C sag	57
6.2 Tokaanu intertrip analysis.....	60
6.3 Huntly – Stratford protection limit analysis.....	61
6.4 Bunnythorpe – Tokaanu 220 kV duplex sensitivity	63
6.5 Tokaanu bus sensitivity study	64
6.6 Wairakei ring sensitivity study	65
7	Conclusion.....68



8
..... **References**
es **69**
Appendix A Monitored circuits **70**
Appendix B TTU and VLR ratings **71**
Appendix C Huntly - Stratford rating **73**
Appendix D Generation dispatch **74**
Appendix E Line parameters **78**



Executive Summary

This report presents the assessment of different Central North Island (CNI) short term and long term options that can be implemented to increase thermal transfer North from Bunnythorpe.

The short term options have been assessed with the goal in mind to identify any “quick wins” that exist and it is expected they can be implemented in 0-5 years whereas the long term options will take approximately 5 - 20 years to implement¹.

The short term options are shown in Table 3 and include tactical thermal upgrades (TTUs), variable line ratings (VLRs), special protection schemes (SPSs), bussing circuits and installing reactors. The long term options are shown in Table 4 and include reconductoring and construction of new lines.

Table 3: Short term upgrade options

No.	Description
01	Tokaanu–Whakamaru 220 kV circuit tactical thermal upgrade to 95°C or 120°C, VLR ratings Minimum and Average
02	Tokaanu–Whakamaru 220 kV circuit tactical thermal upgrade to 95°C or 120°C, VLR ratings Minimum and Average Huntly–Stratford 220 kV protection upgrade
03	Special Protection Scheme, reduction of Tokaanu generation
04	Special Protection Scheme, reduction of Tokaanu and Rangipo generation
05	Bussing 220 kV circuits Bunnythorpe–Tokaanu 1 & 2 and Bunnythorpe–Tangiwai 1
06	Bussing 220 kV circuits Bunnythorpe–Tokaanu 1 & 2 and Rangipo–Tangiwai 1
07	Series reactor on Tokaanu–Whakamaru 1 & 2 circuits
08	Series reactor on Bunnythorpe–Tokaanu 1 & 2 circuits
09	Series reactor on Bunnythorpe–Tokaanu 1 & 2 circuits and on Bunnythorpe–Tangiwai circuit

Table 4: Long term upgrade options

No.	Description
10	Duplex Tokaanu–Whakamaru to ZebraAC at 90°C sag and disable Tokaanu-CB129 intertrip scheme.
11	Duplex Bunnythorpe–Tokaanu and Tokaanu–Whakamaru to ZebraAC at 90°C sag and disable Tokaanu-CB129 intertrip scheme.
12	Duplex Tokaanu–Whakamaru to Sulfur AAAC at 90°C sag and disable Tokaanu-CB129 intertrip scheme.
13	Duplex Bunnythorpe–Tokaanu and Tokaanu–Whakamaru to Sulfur AAAC at 90°C sag and disable Tokaanu-CB129 intertrip scheme.

¹ Detailed project works scheduling has not been completed at this point in time and these timeframes are indicative only.

- Duplex Tokaanu–Whakamaru to ZebraAC at 90°C sag and disable Tokaanu-CB129 intertrip scheme.
- 14 Bus 220 kV circuits near Rangipo, duplex Bunnythorpe–New Station line to ZebraAC at 90°C. Create a new line, Whakamaru–New Station with duplex Sulfur AAAC at 90°C sag.
- 15 New 220 kV Single Circuit Line, between Bunnythorpe and Whakamaru, duplex Sulfur AAAC at 90°C sag
- 16 Reconductor Bunnythorpe-Tokaanu and Tokaanu-Whakamaru with HTLS conductor at 180°C sag.
- 17 New 220 kV double circuit duplex line between Bunnythorpe–Whakamaru, duplex Sulfur AAAC at 90°C sag
- 18 New 220 kV double circuit duplex line between Bunnythorpe–Woodville–Waipawa–Fernhill–Redclyffe, duplex Sulfur AAAC at 90°C sag
- 19 New 220 kV double circuit duplex line between Bunnythorpe–Stratford–Huntly, duplex Sulfur AAAC at 90°C sag

Analysis Method

To calculate the transfer limits for the different reinforcement options the DigSILENT PowerFactory case prepared for the 2021 transmission planning report was used. A fictitious generator was connected at the Bunnythorpe 220 kV substation and the generator's active power increased until monitored circuits reached 100% post contingent loading. The transfer limit was calculated for a selection of different contingencies, these contingencies were regarded as the worst in the area. The worst contingencies were tested because these produce the minimum transfer limit².

For each contingency when post contingent loading on the monitored circuit reached 100% the simulation was stopped, the transfer limit was then calculated. The transfer limit is defined as the sum of active power flowing north on the following six circuits:

1. Bunnythorpe–Tokaanu 1, 220 kV
2. Bunnythorpe–Tokaanu 2, 220 kV
3. Bunnythorpe–Tangiwai 1, 220 kV
4. Brunswick–Bunnythorpe 1, 220 kV
5. Brunswick–Bunnythorpe 2, 220 kV
6. Bunnythorpe–Mataroa 1, 110 kV

The transfer limit was calculated with North Island hydro dispatched at 60%, 70%, 80%, 90% and 100% of maximum output. Hydro generation at Tokaanu has a large impact on loading of the Tokaanu–Whakamaru 220 kV circuits. It can also be considered the CNI network is stressed more when hydro generation is higher.

Short Term Option Analysis Results

A comparison of different short term options was made and this included different TTUs, VLRs, SPSs, Series Reactors and Bussing options. The following combination of preferred uprates has been identified and these increased the transfer limit 145 - 285 MW in the study scenarios:

- Tokaanu–Whakamaru 220 kV circuits with a 95°C TTU and VLR
- The Huntly–Stratford 220 kV protection limit removed

² Thermal transfer limits were calculated in this report, a separate scope of work will assess dynamic stability and dynamic transfer limits.

- A 110 kV system split at Ongarue

The following is noted with regards to the TTU and VLR analysis:

- The preferred split option was found to be at Ongarue, a split at Hangitiki produced some benefit but the transfer limit was capped in most of the simulations by intact network overloading of the Bunnythorpe–Mataroa 110 kV circuit.
- The analysis showed when a 95°C or 120°C TTU with VLR was applied to the Tokaanu–Whakamaru 220 kV circuits the binding constraint became overloading of the Huntly–Stratford 220 kV circuit. Due to this it has been recommended to upgrade the protection relay which is currently limiting the circuit rating.
- The simulations found the most beneficial short term options are implementing a TTU at 95°C or 120°C with VLR on the Tokaanu–Whakamaru 220 kV circuits.
- Shortly after completing the analysis, lab test information was provided by the Transpower lines team which stated 95°C is the most credible sag temperature for a TTU on the Tokaanu–Whakamaru 220 kV circuits. There is some doubt a TTU at 120°C would be compliant with recent grease migration studies and environmental considerations.

Implementation of an SPS, bussing of CNI circuits and installation of reactors was investigated, the following is noted:

- The effectiveness of an SPS which decreased Tokaanu and Rangipo generation post contingency was assessed. The SPS increased the thermal transfer limits however an SPS of this nature would be difficult to implement. Communications would be required between the overloading circuits, Tokaanu Power Station, Rangipo Power Station and the HVDC. The effectiveness of the SPS would be dependent on the runback quantity available at Tokaanu and Rangipo. It is likely the HVDC or other plant would need to keep reserve to balance the reduction in active power at Tokaanu and Rangipo.
- Two different bussing options were assessed. Option 5 tied Bunnythorpe–Tokaanu 1 & 2 and Bunnythorpe–Tangiwai 1 220 kV circuits and Option 6 tied Bunnythorpe–Tokaanu 1 & 2 and Rangipo–Tangiwai 1 220 kV together. Option 5 had negligible affect on system flow and the transfer limit where-as Option 6 decreased the transfer limit. Both bus options are deemed not viable.
- Three different reactor options were assessed, this involved modelling series reactors on the Tokaanu–Whakamaru 220 kV circuits, Bunnythorpe–Tokaanu 220 kV circuits and Bunnythorpe–Tangiwai 220 kV circuit. None of the reactor options proved to be a viable option, the reactors merely shifted the binding constraint from one branch to another. It is possible to optimize the impedance of multiple reactors for a selection of scenarios, but this would provide minimal benefit for the investment made.

Long Term Option Analysis Results

The transfer limit increase for different long term options is shown in Table 5. The highest transfer limit increase was achieved when a new 220 kV double circuit line was built with duplex Sulfur AAAC at 90°C sag and a 95°C TTU with VLR was applied to the existing Tokaanu–Whakamaru and Bunnythorpe–Tokaanu 220 kV circuits. This was Option 17, 18 and 19. The next highest transfer limit increases were achieved with Option 11 and 13 when the existing circuits between Bunnythorpe and Whakamaru were reconducted with duplex ZebraAC or duplex Sulfur AAAC. Reconducting with duplex GoatAC gave a similar average transfer level (≈680 MW).

Table 5: Transfer limit increase for different options (MW)

Option No.	Hydro (%)					Average
	60	70	80	90	100	
Option 18	995	1100	1050	1000	950	1020
Option 17	1060	1025	975	925	875	1010
Option 19	885	960	1035	1085	1090	970

Option 13	600	660	720	775	790	710
Option 11	520	580	640	700	760	640
Option 15	360	345	330	315	300	330
0-5 Year Preferred Short Term Option	135	190	235	260	260	215
Basecase	0	0	0	0	0	0

From the analysis performed the following development path option and programme of works has been identified if duplexing is preferred between Bunnythorpe and Whakamaru substations. The completion of each stage will increase thermal transfer north of Bunnythorpe:

- Stage 1: TTU Tokaanu–Whakamaru 220 kV Circuits, 95°C sag with VLR
- Stage 2: TTU Bunnythorpe–Tokaanu 220 kV Circuits, 95°C sag with VLR
- Stage 3: Duplex Tokaanu–Whakamaru 220 kV Circuits with GoatAC 120°C sag or similar
- Stage 4: Duplex Bunnythorpe–Tokaanu 220 kV Circuits with GoatAC 120°C sag or similar

The following information of note has been identified in the analysis:

- Option 10 and 12 have provided little benefit when compared against the preferred 0-5 year short term option, that is a 95°C TTU with VLR. This is because in both situations the Bunnythorpe–Tokaanu 220 kV circuits limit thermal transfer and when the impedance is reduced on the Tokaanu–Whakamaru 220 kV circuits (by duplexing) power flow increases on Bunnythorpe–Tokaanu 1 and 2 making this constraint bind more easily.
- Option 14, constructing a new substation and new transmission line near Rangipo and bussing the existing circuits provided significantly less benefit than Options 11 and 13.
- Option 15, constructing a new line between Bunnythorpe and Whakamaru 220 kV substations provided significantly less benefit than Option 11 and 13. This is because no other changes were made to the existing grid and the Tokaanu-Whakamaru 220 kV circuits overloaded and limited transfer.
- The effect of the Tokaanu Intertrip Scheme was investigated for different long-term options. It is recommended to disable the scheme if Tokaanu–Whakamaru and Bunnythorpe–Tokaanu are duplexed with ZebraAC at 90°C sag or Sulfur AAAC at 90°C sag or GoatAC at 120°C.
- The effect of the Huntly–Stratford protection upgrade was investigated. Previously it has been thought that if the Tokaanu–Whakamaru circuits are duplexed enough flow might be shifted off Huntly–Stratford to prevent the circuit overloading hence removing the requirement to complete the protection upgrade work. Simulations were completed with and without the protection upgrade and this has shown the protection upgrade significantly increases the transfer limit.

For Option 17, 18 and 19 a new 220 kV double circuit duplex line was built. For these options the transfer limit was constrained by the existing Tokaanu–Whakamaru 220 kV circuits and the limits were similar to Option 11 and 13 (duplex the existing circuits between Bunnythorpe and Whakamaru). The three simulations were completed again with a 95°C TTU and VLR on the Tokaanu–Whakamaru and Bunnythorpe–Tokaanu 220 kV circuits, this time the transfer limit increased significantly. This indicates that if a new line is constructed other upgrade work is required between Bunnythorpe and Whakamaru to unlock a significant portion of the benefit produced by the new line.

For Option 18 two Wairakei Ring sensitivity studies were performed where the Whakamaru–Wairakei 220 kV A line was replaced with a double circuit duplex line and reconducted with duplex GoatAC at 120°C sag. The A line connects at Ohakuri and Atiamuri 220 kV substations and at times can limit transfer through the Wairakei Ring. In this assessment reinforcing the Wairakei ring increased the Bunnythorpe transfer limit 150 - 250 MW and this was dependent on dispatch of Harapaki Wind Farm and Tauhara B Geothermal Power Station.

1 Purpose of this document

The purpose of this report is to present the analysis results of a range of different short term and long term options which have been proposed to increase thermal transfer through the Central North Island (CNI). Power flow and contingency analysis in DigSILENT PowerFactory has been utilized to perform the analysis and make comparisons.

It is expected the short term options could be completed in 0-5 years and the long term options could be implemented in the next 5 - 20 years.

2 Background

Overview

The Central North Island region comprises 220 kV and 110 kV transmission circuits with interconnecting transformers located at Bunnythorpe. The direction of power flow through the region, north or south, is determined by generation, direction of HVDC flow and loads outside the region.

All the 220 kV circuits form part of the grid backbone. The 110 kV transmission network is mainly supplied through the 220/110 kV interconnecting transformers at Bunnythorpe, as well as through low capacity connections to other regions.

The Central North Island region is a main corridor for 220 kV transmission circuits through the North Island. The 220 kV transmission system connects the Central North Island to the Wellington region to the south, the Taranaki region to the west, the Waikato region to the north, and the Hawke's Bay region to the east. A geographic view of the central north island is shown in Figure 10 and the single line diagram is shown in Figure 11.

Current Issues

There are requirements to increase north flow transmission through the CNI region. This requirement would become even more pertinent if the Tiwai Point Aluminium smelter closes. Closure of the smelter would increase the availability of renewable generation in the South Island and if the generation can flow north of Wellington it will increase thermal loading in the CNI region.

Any other potential generation developments around the Bunnythorpe region will load the CNI circuits more heavily. Separately if generation in the Taranaki region is higher this will further stress the CNI region and lower transfer limits north of Bunnythorpe. The potential closure of the Stratford Combined Cycle Plant (≈ 385 MW) will affect CNI transfer levels and this will be monitored closely.

Analysis performed to date in other work streams has shown the two Tokaanu–Whakamaru 220 kV circuits and the Huntly–Stratford 220 kV circuit can constrain north flow through the CNI region.



Figure 10: Geographic view of the Central North Island region transmission network

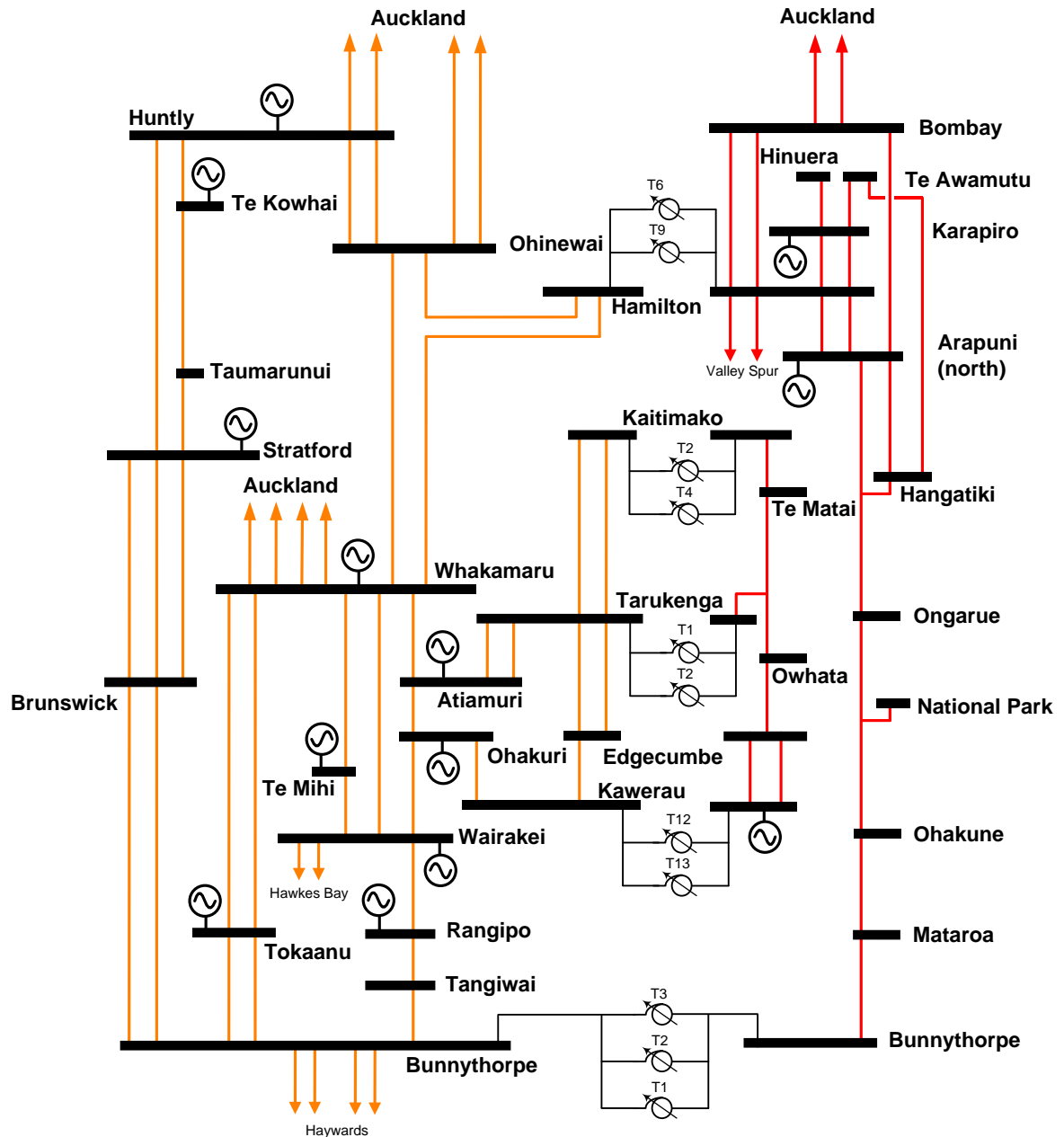

Figure 11: Single line diagram of the Central North Island transmission network

3 Methodology and assumptions

This section explains the method and assumptions used to complete the CNI analysis explained in this report.

3.1 Analysis method

To identify thermal transfer limits across the CNI a fictitious generator was connected at the Bunnythorpe 220 kV substation and its active power increased until monitored circuits reached 100% post contingent loading. To counteract the extra generation dispatched at Bunnythorpe a slack generator was placed at Huntly. For this body of work 15 minute offload times were not used.

The transfer limit was found for the selection of contingency-monitor pairs shown in Table 6. After post contingent loading on the monitor circuit reached 100% the simulation was stopped, the transfer limit was then calculated. The transfer limit is defined as the sum of active power flowing north on the six connecting circuits from Bunnythorpe as listed below:

1. Bunnythorpe–Tokaanu 1, 220 kV
2. Bunnythorpe–Tokaanu 2, 220 kV
3. Bunnythorpe–Tangiwai 1, 220 kV
4. Bunnythorpe–Brunswick 1, 220 kV
5. Bunnythorpe–Brunswick 2, 220 kV
6. Bunnythorpe–Mataroa 1, 110 kV

After the calculation of each transfer limit loading on other circuits in the area was checked. This was performed to ensure no other circuits were overloading in the minimum transfer limit case. The list of checked circuits is shown in Appendix A.

For each of the short term options and long term options the transfer limit was calculated with North Island hydro dispatched at 60%, 70%, 80%, 90% and 100% of maximum output. Hydro generation at Tokaanu has a large impact on loading of the Tokaanu–Whakamaru 220 kV circuits.

Contingency	Monitor
None (Intact Network)	BPE-MTR-1
BPE-TKU-1	BPE-TKU-2
BPE-TKU-1	RPO-TNG-1
BPE-TKU-2	BPE-TNG-1
HLY-SFD-1	TKU-WKM-1
HLY-TWH-1	TKU-WKM-1
RPO-WRK-1	TKU-WKM-1
SFD-TMN-1	TKU-WKM-1
SFD-TMN-1	HLY-SFD-1
SFD-TMN-1	BPE-TNG-1
TKU-WKM-1	RPO-TNG-1
TKU-WKM-1	HLY-SFD-1
TKU-WKM-2	TKU-WKM-1
TKU-WKM-2	HLY-SFD-1
TKU-WKM-2	BPE-TNG-1
TKU-WKM-2	BPE-TKU-1

Table 6: Contingency-Monitor pairs

3.2 Study assumptions

The studies have used the DlgSILENT PowerFactory case prepared for the 2021 transmission planning report.

3.2.1 Asset ratings

The technical analysis was conducted on summer and winter study cases.

- For transmission circuits, the branch rating was used.
- For transformers, the continuous branch limit was used pre-contingency while the post contingency 24-hour branch limit was used post-contingency.

3.2.2 Variable Line Ratings

Some of the analyzed scenarios have tactical thermal upgrades (TTUs) and variable line ratings (VLRs) applied to the Tokaanu–Whakamaru and Bunnythorpe–Tokaanu 220 kV circuits.

To apply TTUs, ACI's Latta Conductor tool was used to calculate upgraded circuit capacities. To apply VLR, data was obtained from the Transpower Lines Team. Appendix B contains the ratings used for the simulations.

3.2.3 Huntly–Stratford protection upgrade

Upgrading the Huntly–Stratford 220 kV circuit has been investigated. The thermal rating of the circuit is currently limited by a protection relay. If the protection limit was removed the branch rating of the circuit would increase to the rating of the circuit conductor. The ratings used for the circuit are shown in Appendix C.

3.2.4 Demand forecast

The island peak prudent forecast (TPR 2021, V1) was used for summer 2025 and winter 2025.

3.2.5 Generation

The analysis assumed the Taranaki Combined Cycle (TCC) and the Huntly Rankine units are decommissioned.

A fictitious generator was connected at the Bunnythorpe 220 kV busbar. This was used to increase power flow north on the North Island grid backbone to find thermal transfer limits. The generator was set to hold the Bunnythorpe 220 kV busbar at 1.02 p.u.

To counteract the extra generation dispatched at Bunnythorpe a slack generator was placed at Huntly. In general, through-out the studies this slack absorbed power.

Appendix D gives a list of generation dispatch settings for both Winter Peak and Summer Peak cases.

3.2.6 Voltage support

As stated in the previous section (3.2.5) the Taranaki Combined Cycle was assumed to be decommissioned. Due to this a generic voltage support device was added at Stratford in the summer peak scenario to provide voltage support for the Taranaki region.

3.2.7 Possible projects

The following projects were assumed complete and in service for the study scenarios:

- Tauhara Generation Station
- Harapaki Wind Farm
- Atiamuri–Ohakuri Series Reactor
- WUNI STATCOM (Hamilton)

4 Analysis results - short term options

This section summarises the short term option analysis performed. Table 7 shows the options considered. **The analysis has been grouped into the following sections:**

- **Thermal Upgrade - Transfer can be increased by raising the thermal sag temperature on the Tokaanu–Whakamaru 220 kV circuits. This effectively increases the rating of the circuits.**
- **SPSs - Loading on Tokaanu–Whakamaru 220 kV circuits can be reduced by ramping back Tokaanu and Rangipo generation post contingency, this could be implemented with a special protection scheme.**
- **Bussing - Circuits geographically close to each other can be connected together or bussed to divert and control power flow.**
- **Reactors - Reactors can be used to restrict flow on circuits and prevent/delay overloading.**

Concurrently two enabling projects were assessed, these projects are:

- A 110 kV system split to prevent overloading of the Bunnythorpe–Mataroa 110 kV circuit. Two different 110 kV split options were assessed, a split at Hangitiki and a split at Ongarue.
- **Removal of the Huntly–Stratford 220 kV circuit protection limit. Currently the circuit rating is limited by a protection relay. If the protection was upgraded the branch rating of the circuit would increase to the rating of the circuit conductor. The impact of completing this upgrade was assessed.**

Table 7: Short term upgrade options

No.	Type	Description
01	Thermal Upgrade	Tokaanu–Whakamaru 220 kV circuit tactical thermal upgrade to 95°C or 120°C, VLR ratings Minimum and Average
02	Thermal Upgrade	Tokaanu–Whakamaru 220 kV circuit tactical thermal upgrade to 95°C or 120°C, VLR ratings Minimum and Average Huntly–Stratford 220 kV protection upgrade
03	SPS	Special Protection Scheme, reduction of Tokaanu generation
04	SPS	Special Protection Scheme, reduction of Tokaanu and Rangipo generation
05	Bussing	Bussing 220 kV circuits Bunnythorpe–Tokaanu 1 & 2 and Bunnythorpe–Tangiwai 1
06	Bussing	Bussing 220 kV circuits Bunnythorpe–Tokaanu 1 & 2 and Rangipo–Tangiwai 1
07	Reactor(s)	Series reactor on Tokaanu–Whakamaru 1 & 2 circuits
08	Reactor(s)	Series reactor on Bunnythorpe–Tokaanu 1 & 2 circuits
09	Reactor(s)	Series reactor on Bunnythorpe–Tokaanu 1 & 2 circuits and on Bunnythorpe–Tangiwai circuit

After assessing the different options, checks were completed to assess any voltage violations present in the cases with the highest thermal transfer limit

4.1 Option 1 and 2

Figure 12 illustrates the Bunnythorpe transfer limit when a 95°C or 120°C TTU is applied with VLR to the Tokaanu–Whakamaru 220 kV circuits. The following points are noted:

- The transfer limit has increased slightly when a split at Ongarue CB82 is applied.
- The transfer limit has increased significantly when a TTU at 95°C is applied to the Tokaanu–Whakamaru 220 kV circuits
- There is little increase in the transfer limit when the highest ratings are applied to the Tokaanu–Whakamaru 220 kV circuits (120°C VLR Average) because post contingent overloading of the Bunnythorpe–Tokaanu 220 kV circuits and the Huntly–Stratford 220 kV circuit occurs which caps the transfer limit.

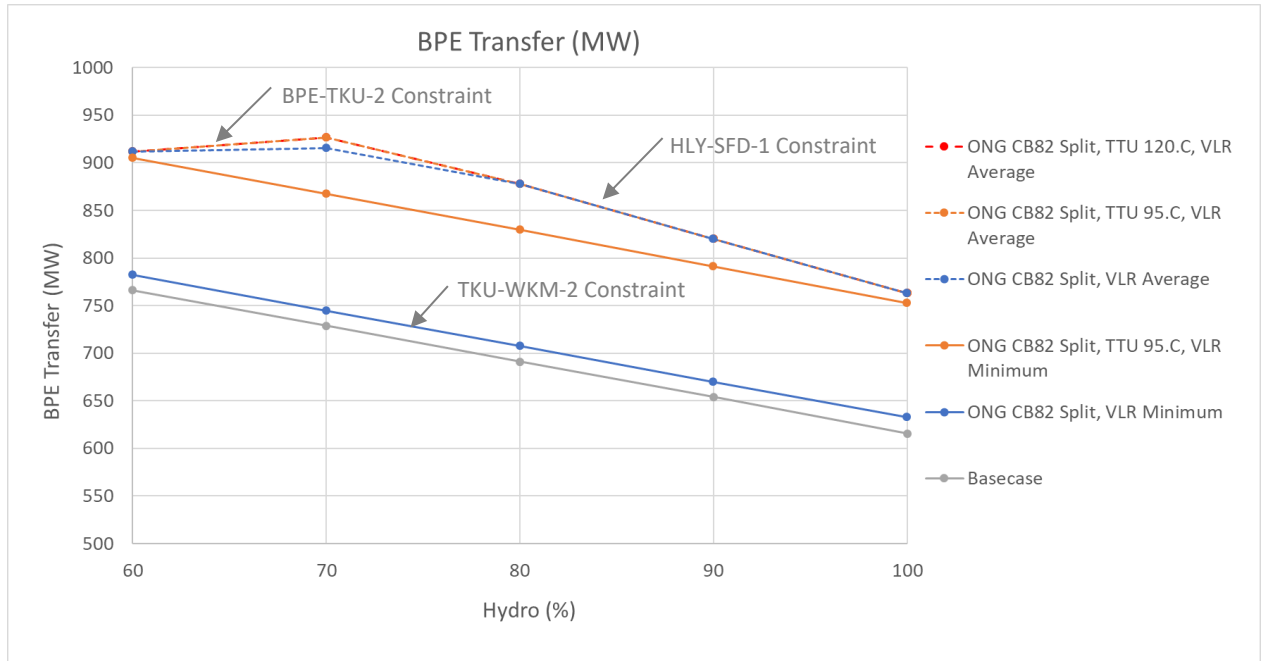

Figure 12: Bunnythorpe transfer limits for different Tokaanu–Whakamaru 220 kV TTU and VLR options

The analysis was repeated with the protection limit removed from the Huntly–Stratford 220 kV circuit, the results are shown in Figure 13. In this scenario post contingent overloading of the Tokaanu–Whakamaru 220 kV circuits or the Bunnythorpe–Tokaanu 220 kV circuits become the binding constraint.

- If the Tokaanu–Whakamaru 220 kV circuits retain their existing 80°C sag temperature the binding constraint was found to be overloading of the Tokaanu–Whakamaru 220 kV circuits.
- With a 95°C TTU applied to the Tokaanu–Whakamaru 220 kV circuits the binding constraint is overloading of the Bunnythorpe–Tokaanu 220 kV circuits and Tokaanu–Whakamaru 220 kV circuits.
- With a 120°C TTU applied to the Tokaanu–Whakamaru 220 kV circuits the binding constraint is overloading of the Bunnythorpe–Tokaanu 220 kV circuits.

It is shown in Figure 13 that a significant amount of capacity is gained when a 95°C TTU is applied on the Tokaanu–Whakamaru 220 kV circuits, however a small amount of extra capacity is gained with a 120°C TTU.

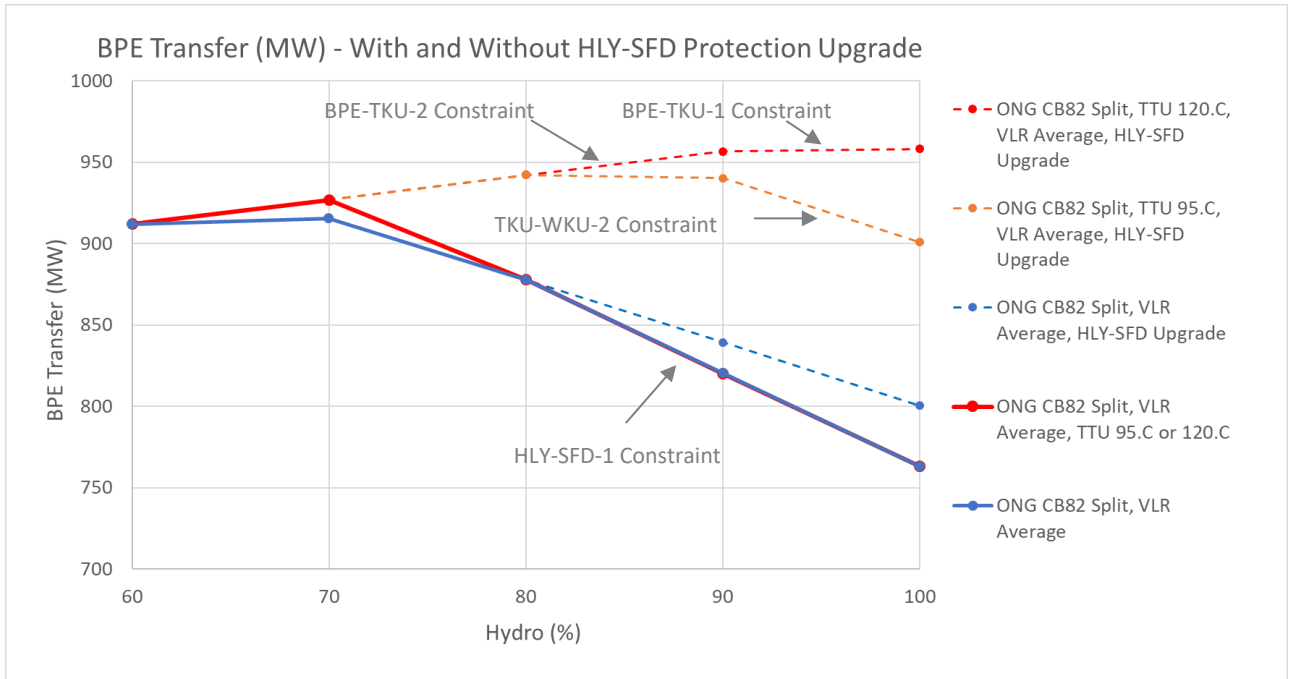

Figure 13: Bunnythorpe transfer limits with and without Huntly–Stratford 220 kV protection upgrade

The impact of the system split at Ongarue CB82 was tested, the results can be seen in Figure 14. In the three cases where a split is not present the Bunnythorpe–Mataroa 110 kV circuit has overloaded and capped the thermal transfer limit.

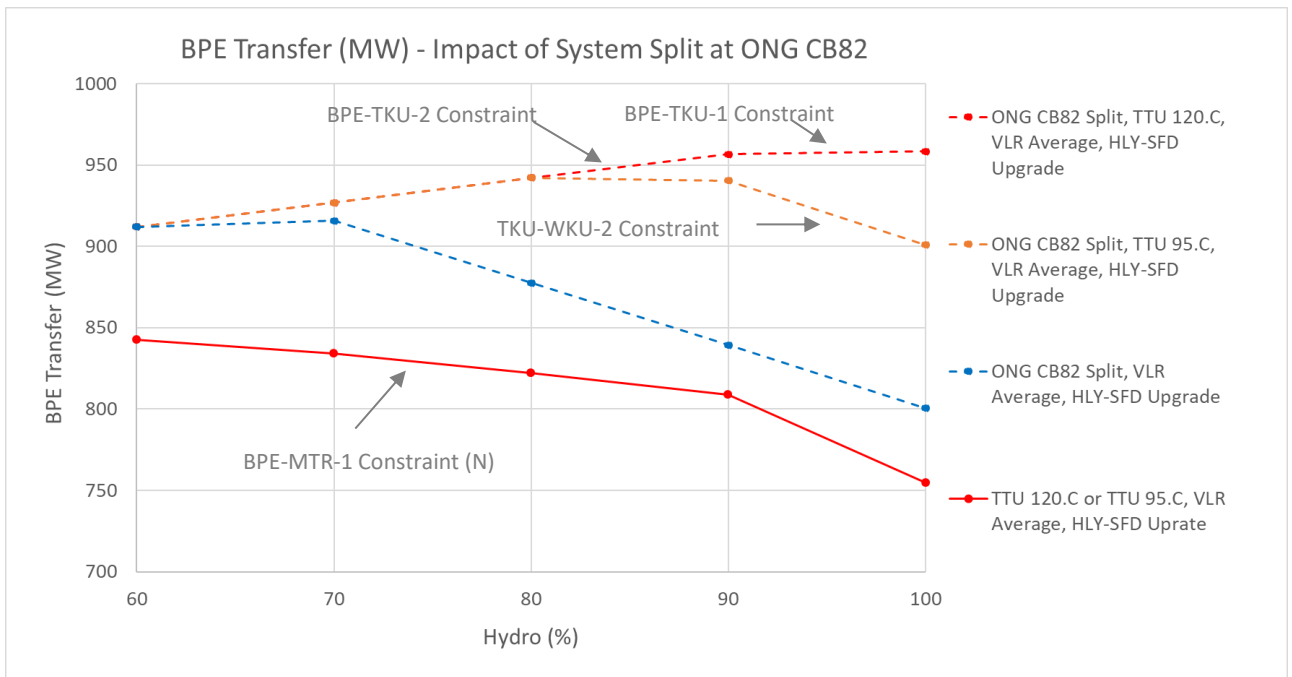

Figure 14: Bunnythorpe transfer limits with and without a split at Ongarue CB82

The impact of the system split at Ongarue CB82 versus a system split at Hangatiki CB72 was tested, the results can be seen in Figure 15. It is clear when a system split is applied at Ongarue the thermal transfer limit is higher.

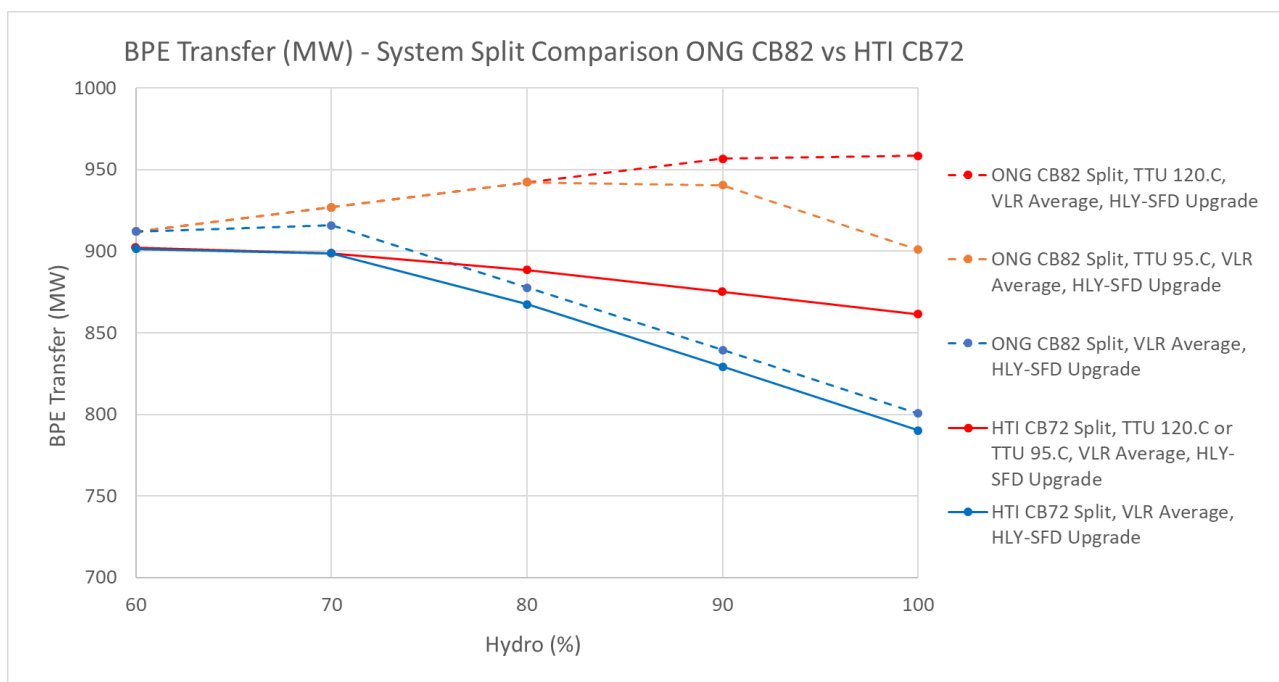

Figure 15: Bunnythorpe transfer limits with a split at Ongarue CB82 versus a split at Hangatiki CB72

Option 1 and 2 Summary

The greatest capacity increase was achieved by implementing a 120°C TTU with VLR on the Tokaanu–Whakamaru 220 kV circuits, this was followed by a 95°C TTU with VLR on the Tokaanu–Whakamaru 220 kV circuits. The capacity increase gained from these options is calculated in Table 8.

Shortly after completing the analysis, lab test information was provided by the Transpower lines team which stated 95°C is the most credible sag temperature for a TTU on the Tokaanu–Whakamaru 220 kV circuits. There is some doubt a TTU at 120°C would be compliant with recent grease migration studies and environmental considerations.

Name	60% hydro (MW)	70% hydro (MW)	80% hydro (MW)	90% hydro (MW)	100% hydro (MW)
Basecase	-	-	-	-	-
Split ONG CB82, TTU 95°C & VLR - Average Rating, HLY-SFD Protection Upgrade	145	195	250	285	285
Split ONG CB82, TTU 120°C & VLR - Average Rating, HLY-SFD Protection Upgrade	145	200	250	305	345

Table 8: Capacity increase with the two most effective options

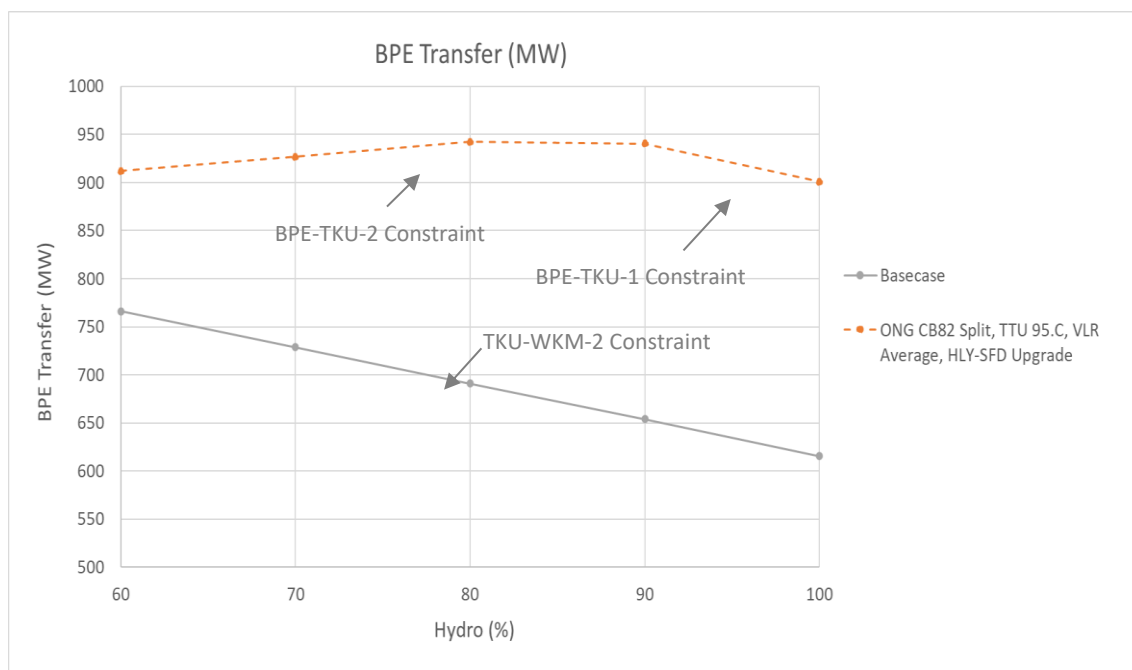

Figure 16: Bunnythorpe transfer limits, base case compared against the TKU-WKM TTU 95°C + VLR option

4.2 Option 3 and 4

An SPS which decreases Tokaanu and Rangipo generation post contingency was investigated. The analysis results are in Figure 17. The x-axis represents the amount of generation reduced by the SPS according to the rating of the Tokaanu and Rangipo power stations, a 20% and 60% reduction of generation for each SPS option is shown in Table 9 for clarity.

SPS Generation	Rating (MW)	20% Reduction (MW)	60% Reduction (MW)
Tokaanu	240	48	144
Tokaanu + Rangipo	370	74	222

Table 9: SPS generation reduction

Figure 17 shows the SPS increases the thermal transfer limit when a TTU and VLR is not applied on the Tokaanu–Whakamaru 220 kV circuits. In this situation the binding constraint is the Tokaanu–Whakamaru 220 kV circuits and the SPS will directly reduce flow on these circuits and enable higher flow on other circuits.

With a TTU applied the SPS has a negative affect because the transfer limit is capped by overloading the Bunnythorpe–Tokaanu 220 kV circuits not the Tokaanu–Whakamaru 220 kV circuits.

Operationally an SPS of this nature would be a difficult solution to implement. Protection-grade communications would be required between the overloading circuits, Tokaanu Power Station, Rangipo Power Station and the HVDC. The effectiveness of the SPS to operate would be dependent on pre-event generation dispatch levels at Tokaanu and Rangipo. It is likely the HVDC

would need to keep reserve to balance the reduction in active power at Tokaanu and Rangipo. To implement this option consultation would be required with the generator asset owners and the system operator.

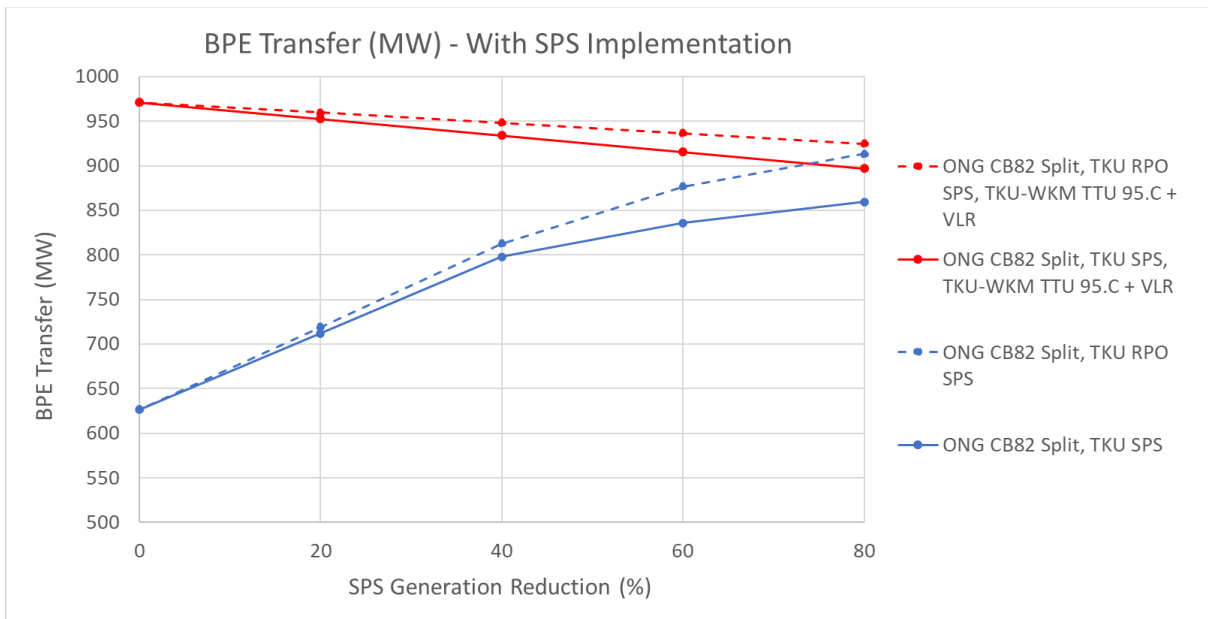

Figure 17: Bunnythorpe transfer limit with a SPS implemented at Tokaanu and Rangipo

4.3 Option 5

This option busses (connects) three 220 kV circuits together, Bunnythorpe–Tokaanu 1 & 2 and Bunnythorpe–Tangiwai 1. Figure 18 and Figure 19 show the new 220 kV busbar that was created. In this new configuration the Tangiwai load effectively gets changed from a loop-in station to a spur load fed by two circuits from the newly created Tangiwai busbar.

At this stage the physical practicalities of this option have been ignored to allow for a high-level power flow assessment.

Bussing these circuits had negligible effect on the Bunnythorpe transfer limit. Hence, a graph is not presented for this non-viable option.



Figure 18: Option 5 map

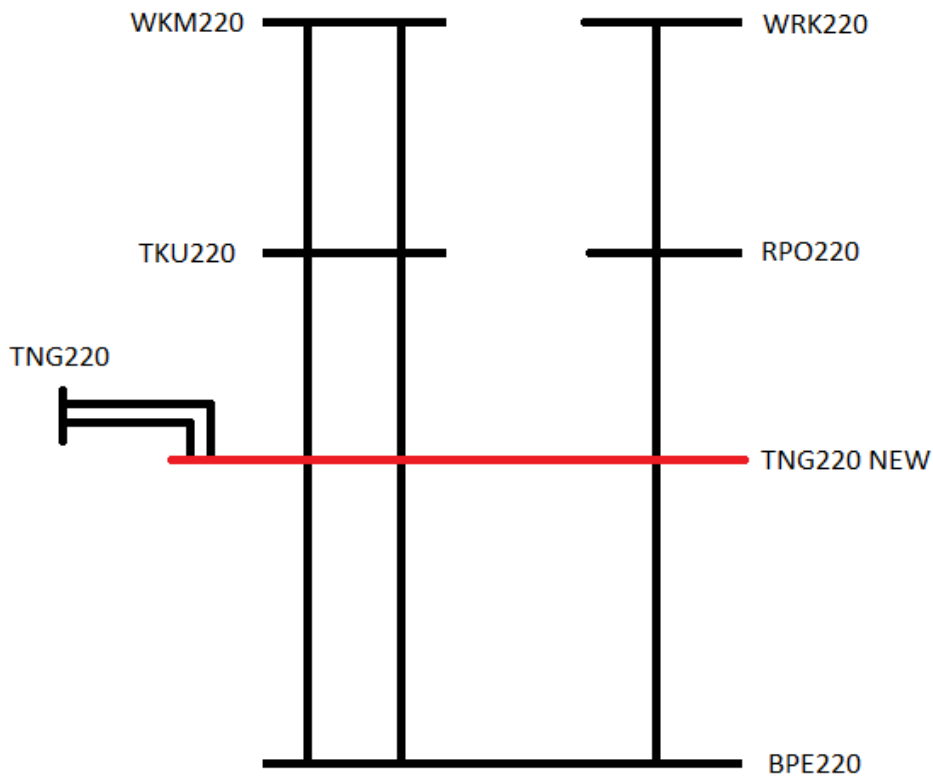

Figure 19: Option 5 schematic

4.4 Option 6

For Option 6 it was decided to bus three 220 kV circuits further north, that is Bunnythorpe–Tokaanu 1 & 2 and Rangipo–Tangiwai 1. Figure 20 and Figure 21 show the new 220 kV busbar that was created. In this new configuration Rangipo generation effectively gets changed from a loop in station to a spur fed by two circuits from the newly created Rangipo busbar.

At this stage the physical practicalities of this option have been ignored to allow for a high-level power flow assessment.



Figure 20: Option 6 map

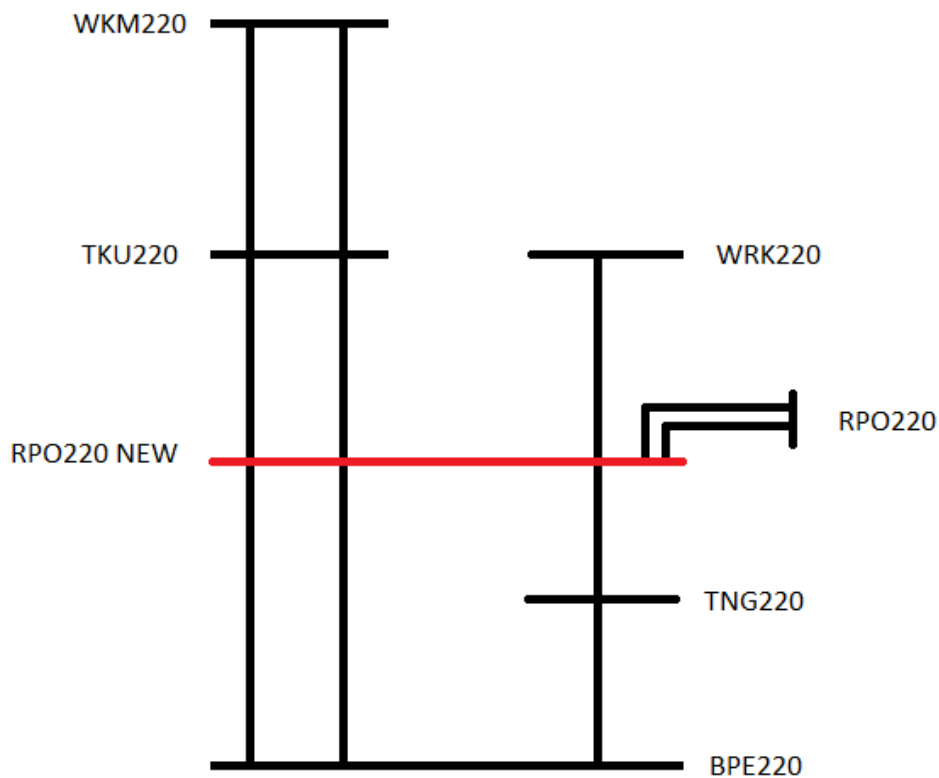

Figure 21: Option 6 schematic

Figure 22 shows the transfer limit is less (solid purple trace) when a new bus is created at Rangipo. This is due to Rangipo generation being connected directly to the Bunnythorpe–Tokaanu 220 kV circuits, in the study this increased flow on the Tokaanu–Whakamaru 220 kV circuits. If one of these circuits are tripped the new Rangipo bus should be split otherwise the effectiveness of the existing Tokaanu intertrip scheme is negated. Even with the SPS enabled the transfer limit has not increased enough, hence this bus option is not viable.

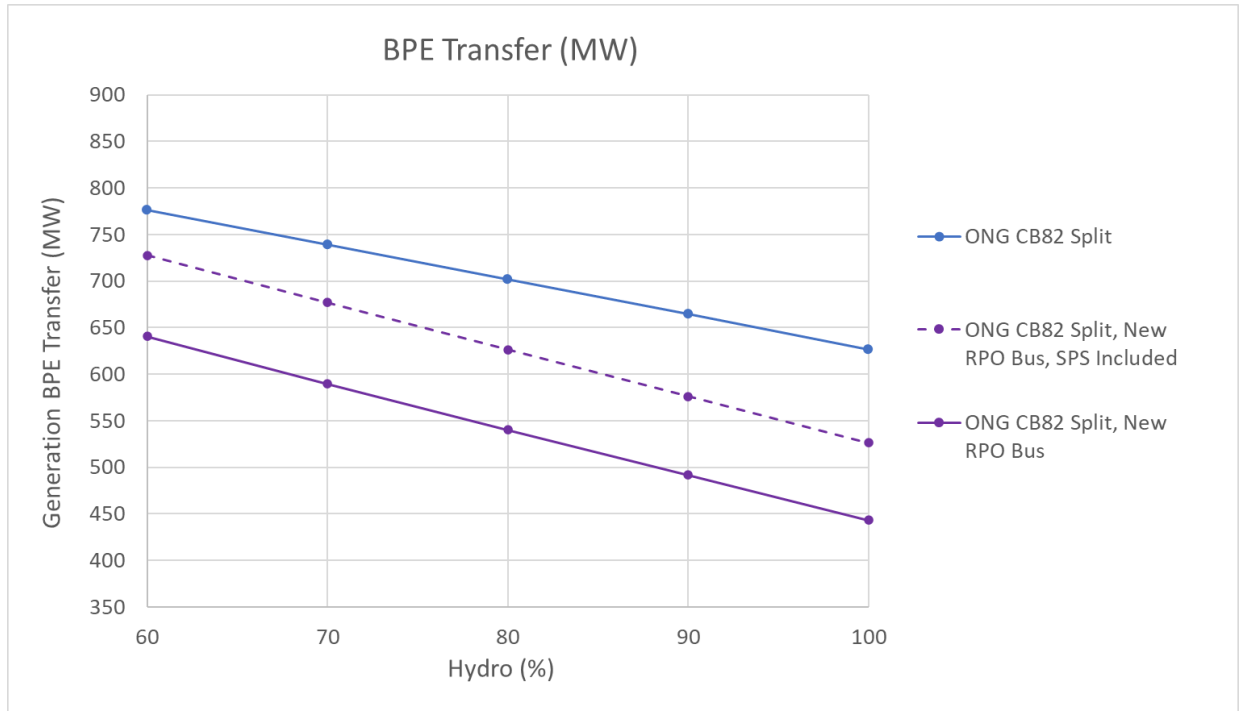

Figure 22: Bunnythorpe transfer limit with new Rangipo 220 kV bus

4.5 Option 7

For this option two series reactors with 25Ω impedance were modelled, one on each Tokaanu–Whakamaru 220 kV circuit. A range of reactor impedances were tested (5Ω - 50Ω) and 25Ω was suitable to prevent the Tokaanu–Whakamaru 220 kV circuits overloading for a contingency of the other circuit.

With the reactors in service the Huntly–Stratford 220 kV circuit became the binding constraint. The protection relay upgrade was then applied to the circuit, the binding constraint became post contingent overloading of the Tokaanu–Whakamaru 220 kV circuits or the Bunnythorpe–Tangiwai 220 kV circuit. A larger reactor was investigated but this exacerbated loading on Bunnythorpe–Tangiwai.

A plot of the transfer limit achieved in each simulation is shown in Figure 23. With two reactors and the Huntly–Stratford protection relay upgrade the transfer limit is less than that achieved with a 95°C TTU and VLR on the Tokaanu–Whakamaru 220 kV circuits.

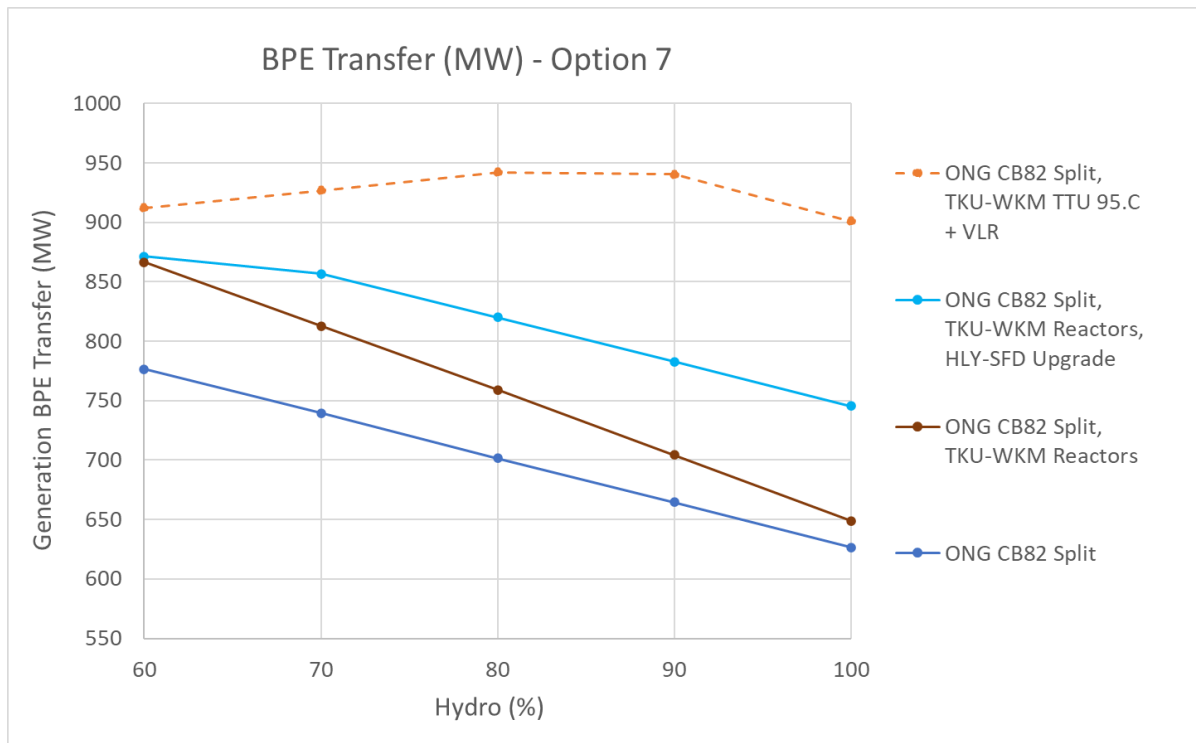

Figure 23: Bunnythorpe transfer limits with Option 7

4.6 Option 8

For this option two series reactors with 30Ω impedance were modelled, one on each Bunnythorpe -Tokaanu 220 kV circuit. A range of reactor impedances were tested (10Ω - 60Ω) and 30Ω was suitable to prevent the Tokaanu-Whakamaru 220 kV circuits overloading for a contingency of the other circuit.

With the reactors in service the Huntly-Stratford 220 kV circuit became the binding constraint. The protection relay upgrade was then applied to the circuit, the binding constraint then became post contingent overloading of the Tokaanu-Whakamaru 220 kV circuits or the Bunnythorpe-Tangiwai 220 kV circuit. A larger reactor was investigated but this exacerbated loading on Bunnythorpe-Tangiwai.

A plot of the transfer limit achieved in each simulation is shown in Figure 24. With two reactors and the Huntly-Stratford protection relay upgrade the transfer limit is less than that achieved with a 95°C TTU and VLR on the Tokaanu-Whakamaru 220 kV circuits from Phase 1.

4.7 Option 9

Option 8 was used and a 30Ω series reactor was added to the Bunnythorpe-Tangiwai 220 kV circuit. In total three reactors are in service for this option. With the third reactor added the binding constraint became post contingent overloading of the Huntly-Stratford 220 kV circuit. If a reactor with larger impedance was added the Tokaanu-Whakamaru 220 kV circuits became overloaded.

The transfer limit achieved is shown in Figure 24, Option 9 is the dark green trace.

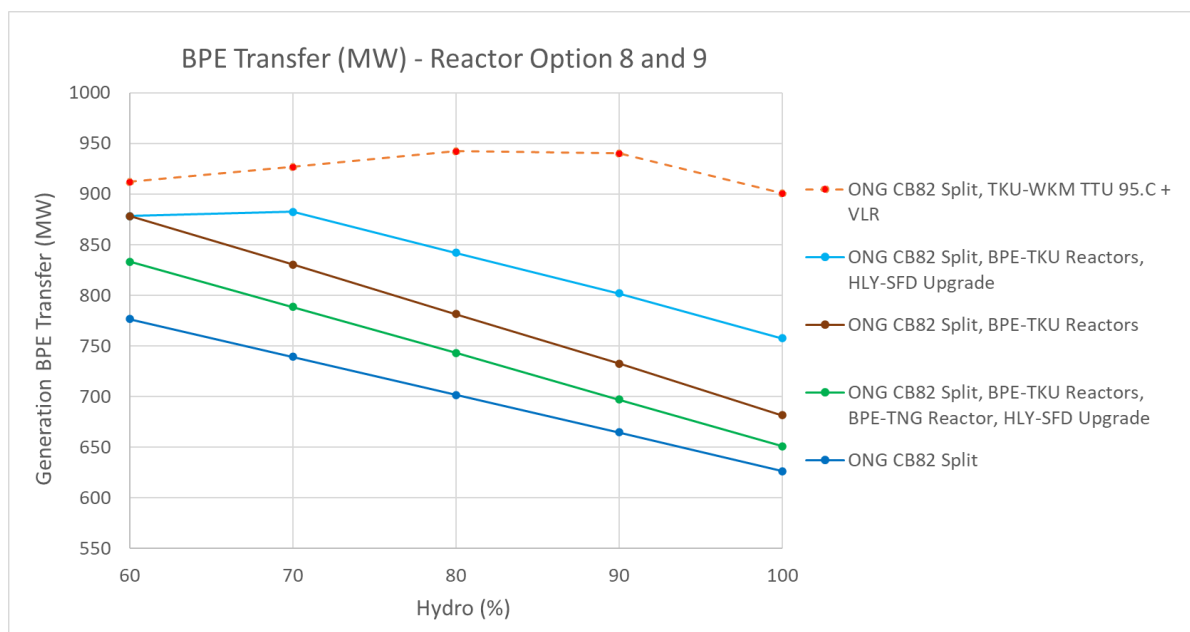

Figure 24: Bunnythorpe transfer limits with reactor Option 8 and 9

Reactor options summary

None of the reactor options assessed have proved to be viable options. Installing reactors on either the Tokaanu–Whakamaru 220 kV circuits, the Bunnythorpe–Tokaanu 220 kV circuits or the Bunnythorpe–Tangiwai 220 kV circuit merely shifts the binding constraint from one branch to another. It is possible to optimize the impedance of multiple reactors for a selection of scenarios, but this is not recommended.

4.8 Preferred updates

A comparison of different short term options was made and this included different TTUs, VLRs, SPSS, Series Reactors and Bussing options. The following combination of preferred updates has been identified and these increased the transfer limit 145 - 285 MW in the study scenarios:

- Tokaanu–Whakamaru 220 kV circuits with a 95°C TTU and VLR
- The Huntly–Stratford 220 kV protection limit removed
- A 110 kV system split at Ongarue

Shortly after completing the analysis, lab test information was provided by the Transpower lines team which stated 95°C is the most credible sag temperature for a TTU on the Tokaanu–Whakamaru 220 kV circuits. There is some doubt a TTU at 120°C would be compliant with recent grease migration studies and environmental considerations.

5 Analysis results - long term options

Based on the short term option analysis results a system split at Ongarue Circuit Breaker (CB) 82 and the Huntly–Stratford protection upgrade were assumed to be in place for the long term option studies. This is required because otherwise the transfer capacity would be curtailed for all options and a direct comparison between options would not be possible.

Table 10 shows the long term options that have been assessed and the electrical parameters for each option are displayed in Appendix E. In this report section the thermal capacity graphs contain two fixed trends for comparison purposes:

- Black Dashed Line – Base case, nothing is done
- Dark Blue Dashed Line – The preferred upgrades identified in the short term option analysis:
 - A 110 kV system split at Ongarue CB82, the exact position of the system split is currently being investigated in a separate work stream.
 - Tokaanu–Whakamaru 220 kV circuits with a 95°C TTU and VLR³
 - The Huntly–Stratford 220 kV protection limit removed

Table 10: Long term upgrade options

No.	Description
10	Duplex Tokaanu–Whakamaru to ZebraAC at 90°C sag and disable Tokaanu-CB129 intertrip scheme.
11	Duplex Bunnythorpe–Tokaanu and Tokaanu–Whakamaru to ZebraAC at 90°C sag and disable Tokaanu–CB129 intertrip scheme.
12	Duplex Tokaanu–Whakamaru to Sulfur AAAC at 90°C sag and disable Tokaanu-CB129 intertrip scheme.
13	Duplex Bunnythorpe–Tokaanu and Tokaanu–Whakamaru to Sulfur AAAC at 90°C sag and disable Tokaanu-CB129 intertrip scheme. Duplex Tokaanu–Whakamaru to ZebraAC at 90°C sag and disable Tokaanu-CB129 intertrip scheme.
14	Bus 220 kV circuits near Rangipo, duplex Bunnythorpe–New Station line to ZebraAC at 90°C. Create a new line, Whakamaru–New Station with duplex Sulfur AAAC at 90°C sag.
15	New 220 kV Single Circuit Line, between Bunnythorpe and Whakamaru, duplex Sulfur AAAC at 90°C sag
16	Reconductor Bunnythorpe–Tokaanu and Tokaanu–Whakamaru with HTLS conductor at 180°C sag.
17	New 220 kV double circuit duplex line between Bunnythorpe–Whakamaru, duplex Sulfur AAAC at 90°C sag
18	New 220 kV double circuit duplex line between Bunnythorpe–Woodville–Waipawa–Fernhill–Redclyffe, duplex Sulfur AAAC at 90°C sag
19	New 220 kV double circuit duplex line between Bunnythorpe–Stratford–Huntly, duplex Sulfur AAAC at 90°C sag

³ The short term option studies considered a TTU to 95°C and 120°C but to be conservative, a TTU at 95°C is assumed in the long term analysis as there are legal and environmental issues that are yet to be resolved for operating at 120°C which is above tested grease migration temperatures.

5.1 Option 10 and 11

The Transfer limits are shown in Figure 25 for the following options:

- Option 10 - Duplex Tokaanu–Whakamaru to ZebraAC at 90°C sag and disable Tokaanu-CB129 intertrip scheme.
- Option 11 - Duplex Bunnythorpe–Tokaanu and Tokaanu–Whakamaru to ZebraAC at 90°C sag and disable Tokaanu-CB129 intertrip scheme.

Duplexing the Tokaanu–Whakamaru 220 kV circuits produces a slightly lower transfer limit than that achieved with the preferred uprates (TTU at 95°C). When the impedance is reduced on the Tokaanu–Whakamaru circuits (by duplexing) power flow increases on Bunnythorpe–Tokaanu 1 and 2.

When hydro is dispatched lower than 80% the Bunnythorpe–Tokaanu 220 kV circuits are the limiting constraint. Figure 25 shows when both Tokaanu–Whakamaru 220 kV and Bunnythorpe–Tokaanu 220 kV are duplexed the greatest thermal capacity increase is achieved. For this option the limiting constraint is a Bunnythorpe–Tokaanu circuit contingency overloading Bunnythorpe–Tangiwai 1.

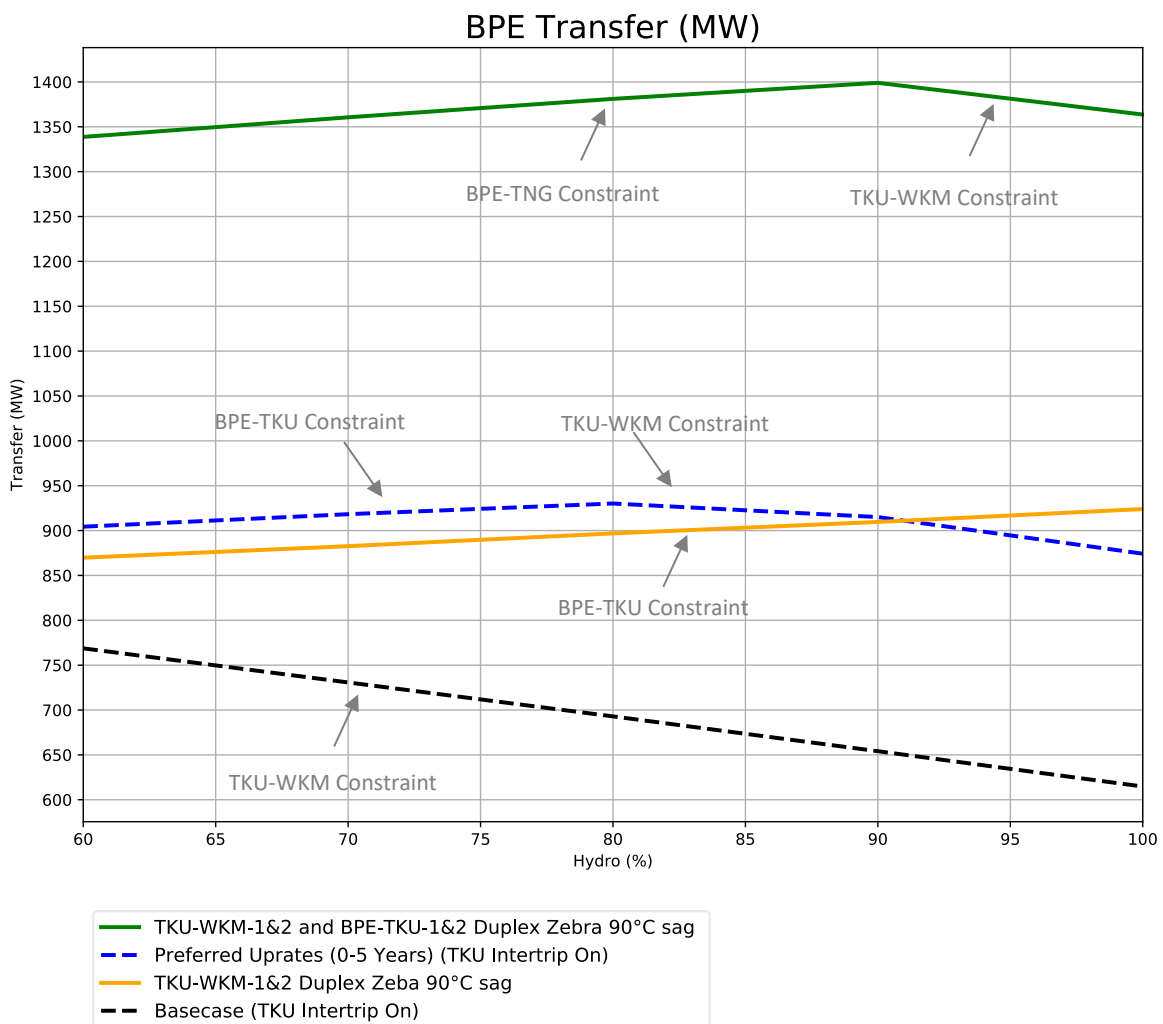

Figure 25: Option 10 and 11 transfer limits

5.2 Option 12 and 13

The transfer limits are shown in Figure 26 for the following options:

- Option 12 - Duplex Tokaanu–Whakamaru to Sulfur AAAC at 90°C sag and disable Tokaanu-CB129 intertrip scheme.
- Option 13 - Duplex Bunnythorpe–Tokaanu and Tokaanu–Whakamaru to Sulfur AAAC at 90°C sag and disable Tokaanu-CB129 intertrip scheme.

Similar to Option 10, duplexing the Tokaanu–Whakamaru 220 kV lines (only) produces a slightly lower transfer limit than that achieved with the preferred uprates (TTU at 95°C).

With Both Tokaanu–Whakamaru 220 kV circuits and Bunnythorpe–Tokaanu 220 kV circuits duplexed with Sulfur AAAC the transfer limit is highest because this conductor has the lowest impedance and highest thermal rating. For this option the limiting constraint is a Bunnythorpe–Tokaanu circuit contingency overloading Bunnythorpe–Tangiwai–1.

Figure 26 shows this option provides the greatest thermal capacity.

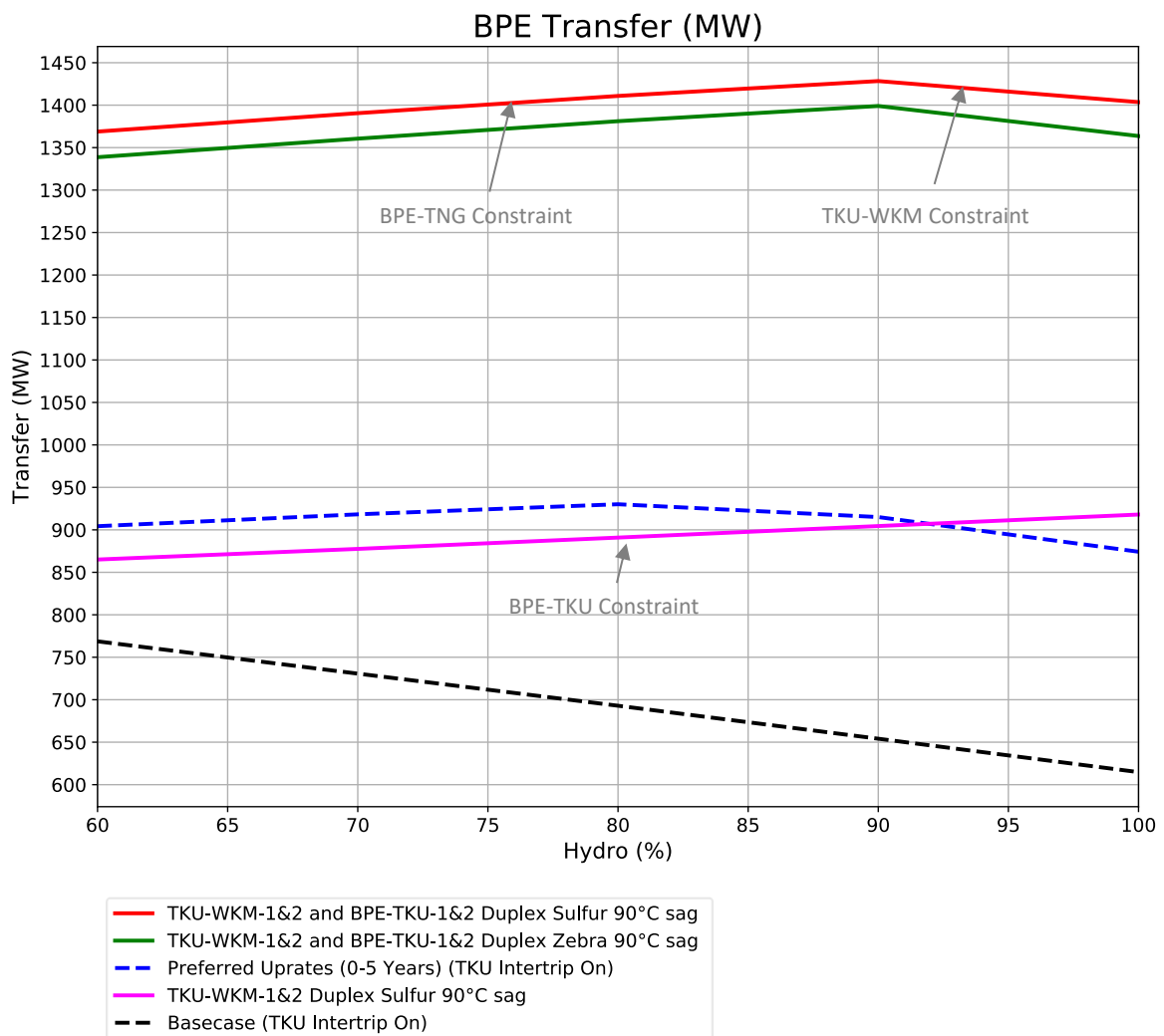

Figure 26: Option 12 and 13 transfer limits

5.3 Option 14

For Option 14 the circuit schematic and transfer limit are shown in Figure 27 and Figure 28 respectively. This option involves the following:

- Duplex Tokaanu–Whakamaru to ZebraAC at 90°C sag and disable Tokaanu-CB129 intertrip scheme.
- Bus 220 kV circuits near Rangipo, duplex the Bunnythorpe–New Station line with ZebraAC at 90°C.
- Create a new line between Whakamaru and New Station with duplex Sulfur AAAC at 90°C sag.

For this option it is assumed a circuit overload protection scheme (COPS) has been implemented on the two 220 kV circuits between the New Station and Tokaanu. Otherwise, a contingency of one of these circuits will overload the other at low transfer levels.

Even with the COPS in service Figure 28 shows the transfer limit is far less than that achieved by duplexing Tokaanu–Whakamaru and Bunnythorpe–Tokaanu 220 kV circuits with ZebraAC at 90°C. This is due to a contingency of a Bunnythorpe–New Station line circuit overloading the Bunnythorpe–Tangiwai circuit. Flow has increased on the Bunnythorpe–New Station Lines because of duplex reconductoring and the new Bunnythorpe–Whakamaru 220 kV circuit. When a Bunnythorpe–New Station line contingency occurs a large amount of the flow shifts onto the remaining Bunnythorpe–New Station Line and parallel Bunnythorpe–Tangiwai circuit.

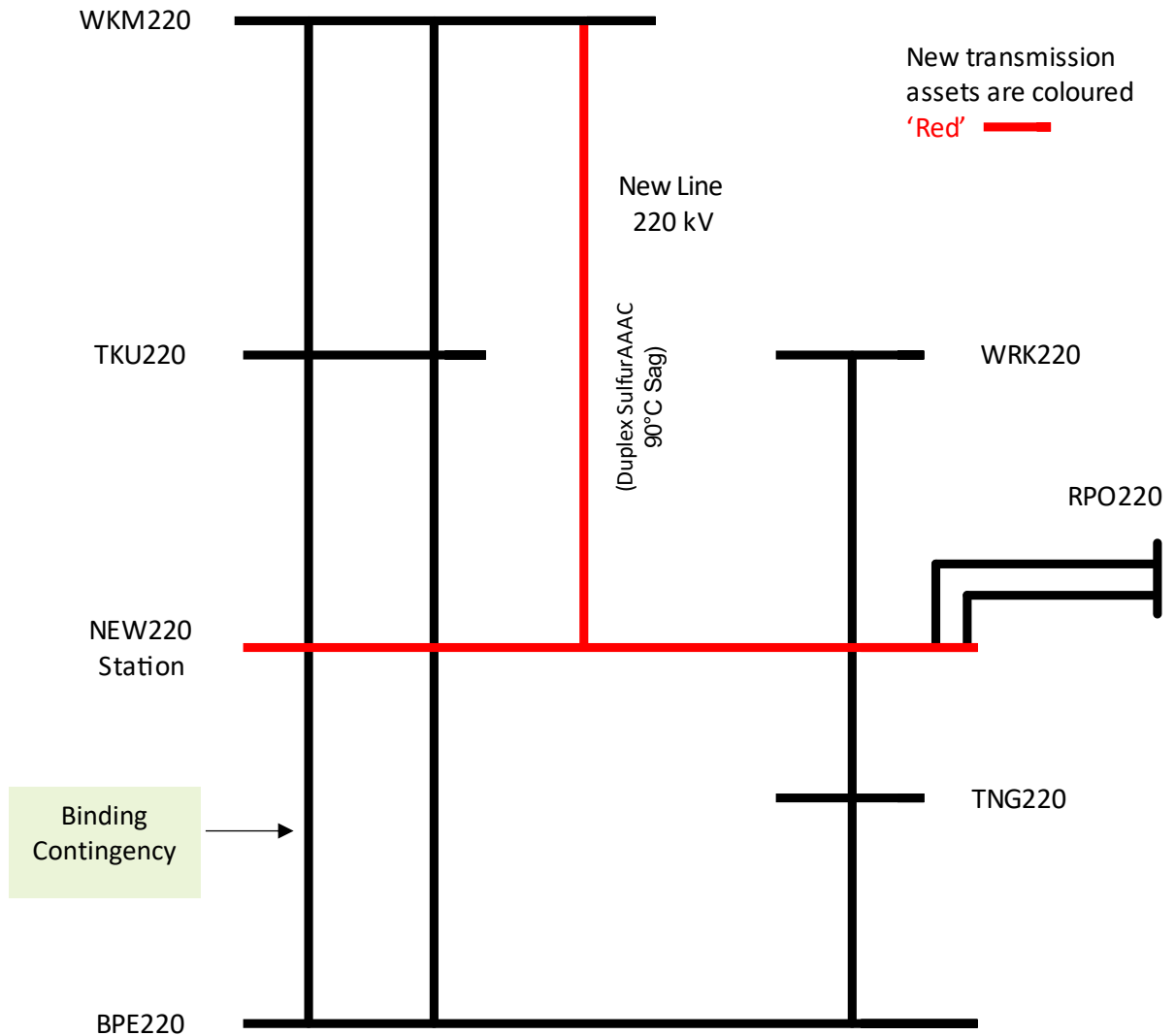

Figure 27: SLD for new station near RPO + duplex zebra reinforcement + new line, duplex Sulfur

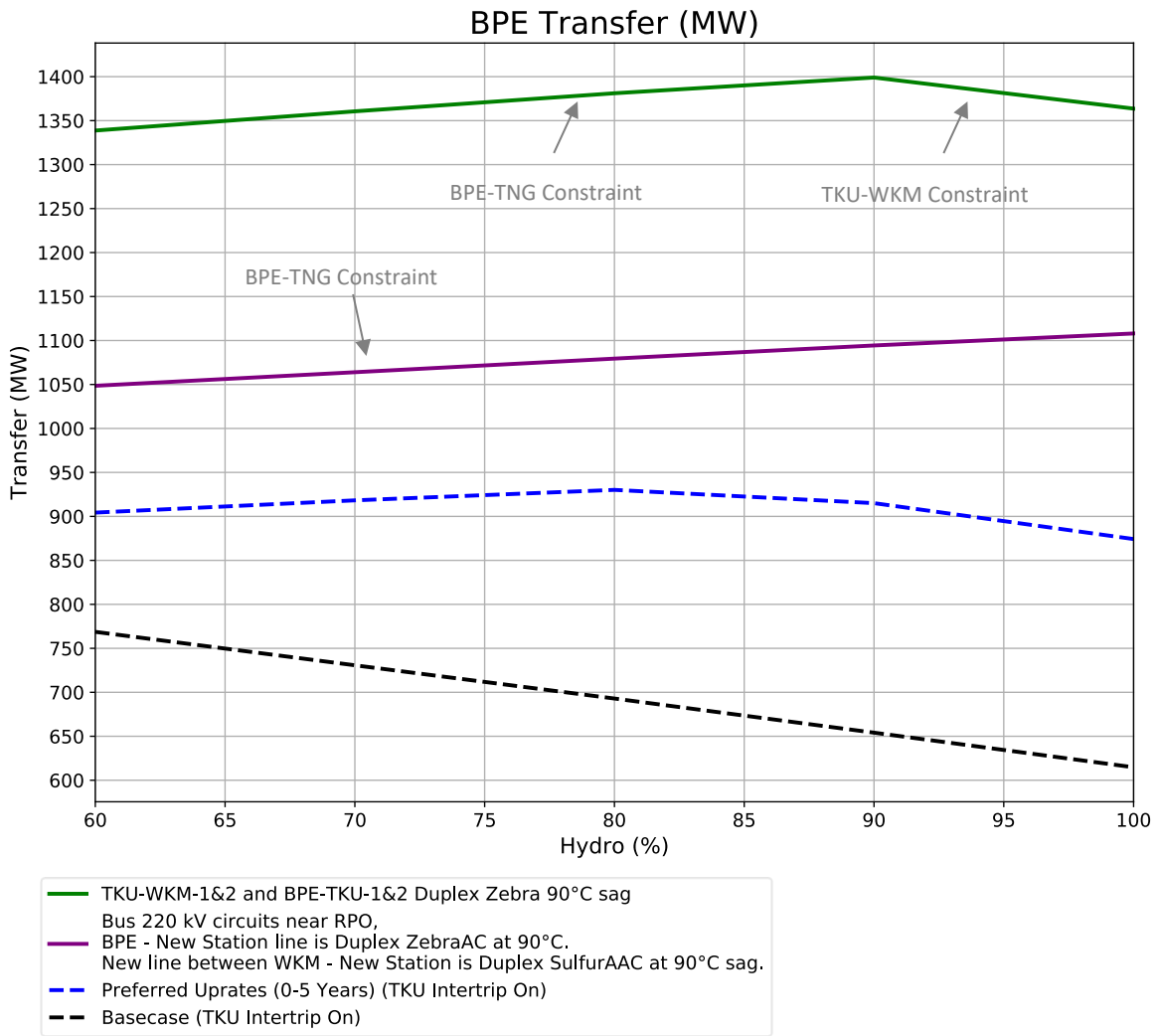

Figure 28: Option 14 transfer limits

5.4 Option 15

The transfer limit for Option 15 is shown in Figure 29. This option involves construction of a new 220 kV Single Circuit Line between Bunnythorpe and Whakamaru with Duplex Sulfur AAAC at 90°C sag. The transfer limit is higher than that achieved with the preferred uprates (TTU at 95°C) from the 0-5 year short term option analysis but lower than Option 11 when the circuits between Bunnythorpe and Whakamaru are duplexed with ZebraAC at 90°C sag. The limiting constraint is a contingency of one Tokaanu–Whakamaru 220 kV circuit overloading the remaining Tokaanu–Whakamaru 220 kV circuit.

The new Bunnythorpe–Whakamaru 220 kV circuit did not shift enough flow off the Tokaanu–Whakamaru 220 kV circuits to significantly increase the thermal transfer limit. Generation from the Tokaanu Power Station significantly affects loading on these circuits.

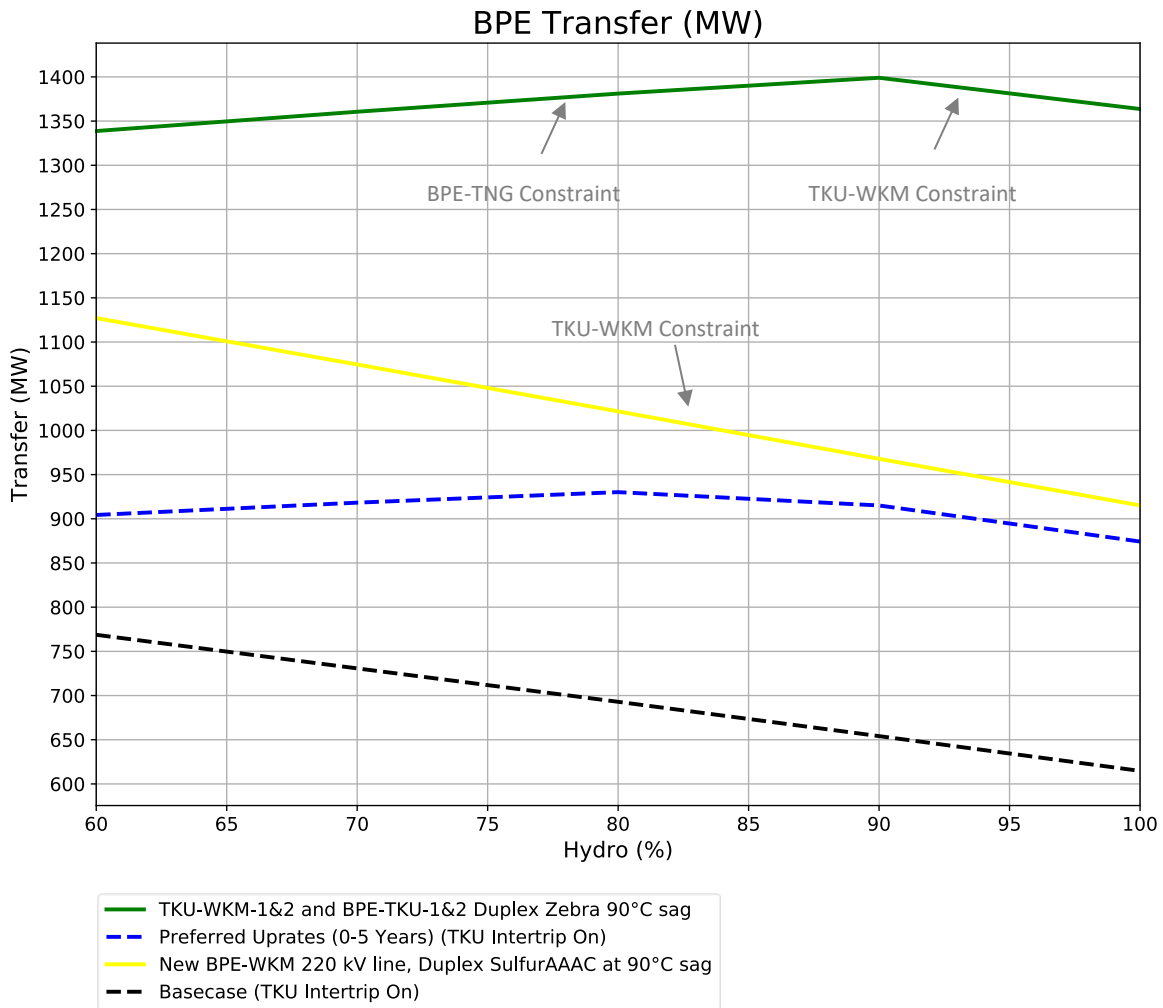

Figure 29: Option 15 transfer limits

5.5 Option 16

The transfer limit for Option 16 is shown in Figure 30. This option involves reconductoring the Bunnythorpe–Tokaanu and Tokaanu–Whakamaru circuits with HTLS at 180°C sag.

Two transfer limits have been calculated, one with the Tokaanu Intertrip Scheme in service and one without it. The relevant trends in Figure 30 are the solid pink trend and dashed pink trend. For these simulations a TTU was applied to the Bunnythorpe–Tangiwai, Rangipo–Tangiwai and Rangipo–Wairakei 220 kV circuits to prevent them from overloading and constraining transfer north. More information regarding a TTU of the Bunnythorpe–Wairakei branch is given in section 6.1.

When the Intertrip Scheme is in service the limiting constraint is a contingency of one Tokaanu–Whakamaru 220 kV circuit overloading the Bunnythorpe–Tangiwai 220 kV circuit. If the scheme is out of service a contingency of one Tokaanu–Whakamaru 220 kV circuit begins to overload the remaining circuit.

Figure 30 illustrates that even with the TTU applied on the Bunnythorpe–Wairakei branch the transfer limit is lower than Option 11. Therefore, HTLS with a 180°C sag temperature is not as effective.

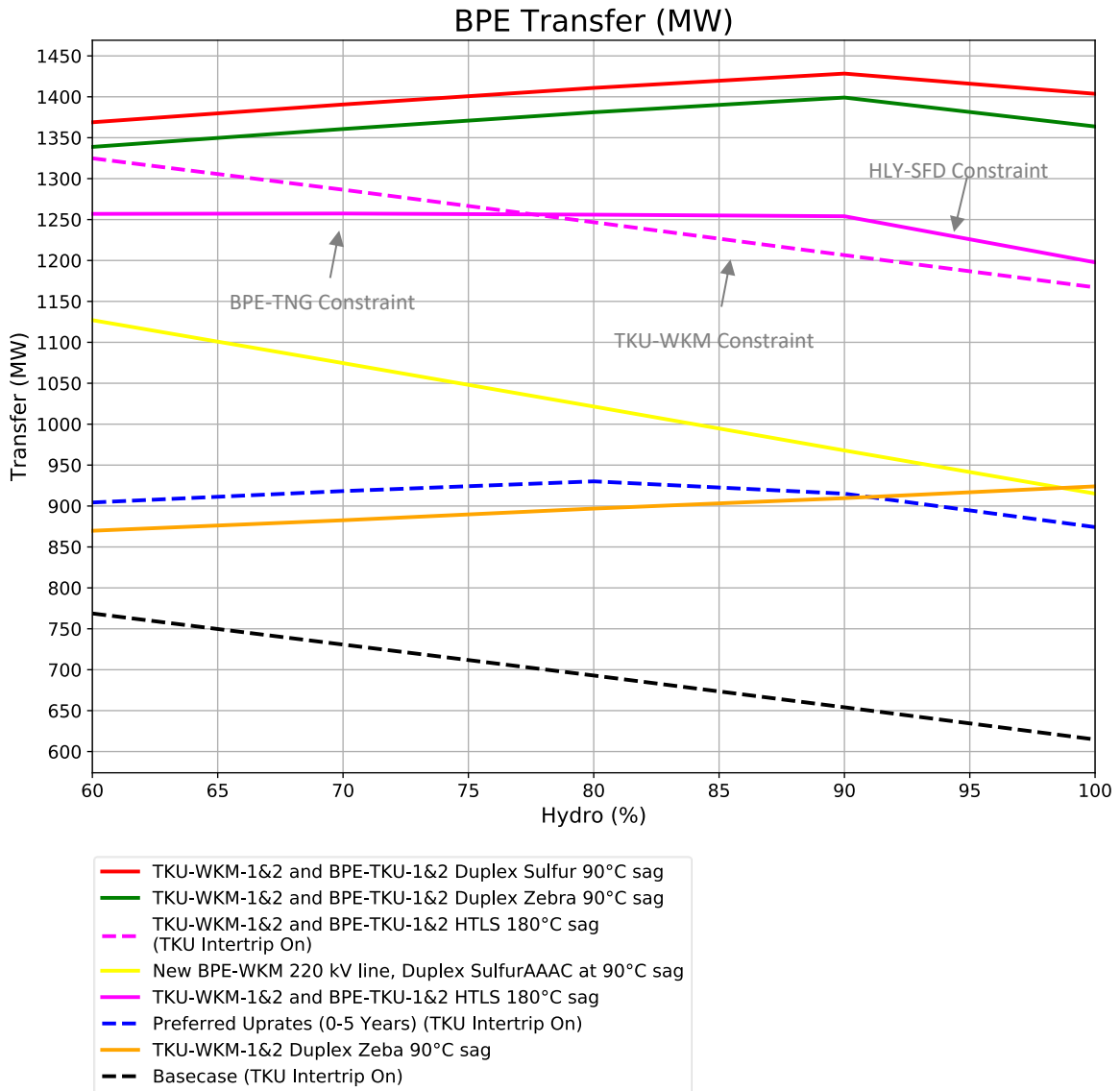

Figure 30: Option 16 transfer limits

5.6 Option 17, 18 and 19

In the Transpower NZGP long list document (Transpower, 2021) several options were proposed which involve building a new 220 kV double circuit duplex line, the options are shown in Table 11.

Figure 31 shows a map of the central north island and the three existing line routes, for modelling purposes it has been assumed the new line routes would be similar. The map is presented for illustration purposes, if one of these options was constructed the line route would be designed correctly and significant consideration would be given to land access requirements and other planning measures.

Table 11: Double circuit duplex lines

Option Number	Description
17	New 220 kV double circuit duplex line between Bunnythorpe–Whakamaru, duplex Sulfur AAAC at 90°C sag
18	New 220 kV double circuit duplex line between Bunnythorpe–Woodville–Waipawa–Fernhill–Redclyffe, duplex Sulfur AAAC at 90°C sag
19	New 220 kV double circuit duplex line between Bunnythorpe–Stratford–Huntly, duplex Sulfur AAAC at 90°C sag

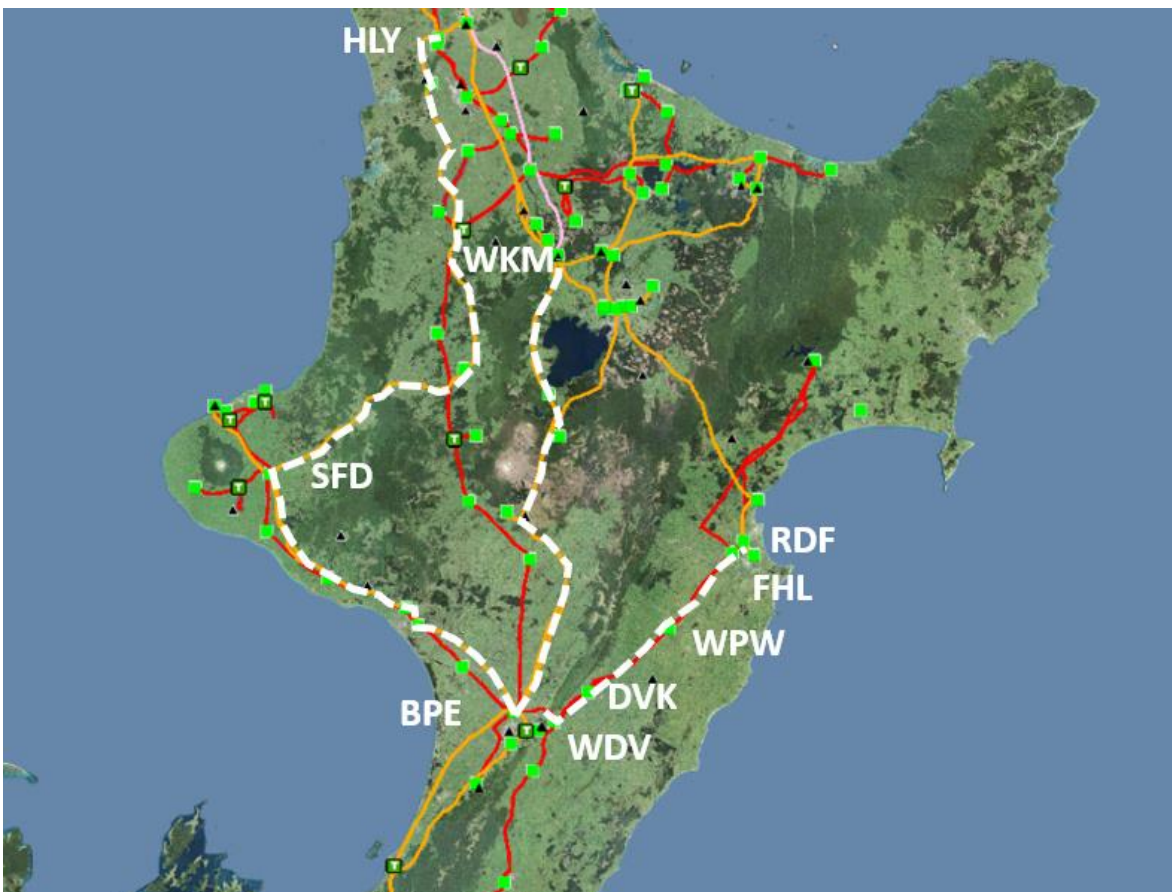

Figure 31: Geographical map of double circuit duplex options

The Transfer limit is shown in Figure 32 for the following options:

- New 220 kV double circuit duplex line between Bunnythorpe–Whakamaru, duplex Sulfur AAAC at 90°C sag
- New 220 kV double circuit duplex line between Bunnythorpe–Woodville–Waipawa–Fernhill–Redclyffe, duplex Sulfur AAAC at 90°C sag
- New 220 kV double circuit duplex line between Bunnythorpe–Stratford–Huntly, duplex Sulfur AAAC at 90°C sag

The three double circuit duplex options have produced a transfer limit similar to Option 11 which was assessed in section 5.1. Option 11 involved duplexing Bunnythorpe–Tokaanu and Tokaanu–Whakamaru with ZebraAC at 90°C sag. In all three double circuit duplex options the transfer limit was constrained by the Tokaanu–Whakamaru circuits. Due to this the simulations were completed again with a 95°C TTU and VLR on the Tokaanu–Whakamaru and Bunnythorpe–Tokaanu 220 kV circuits. Figure 33 shows there is a significant increase in the transfer limit.

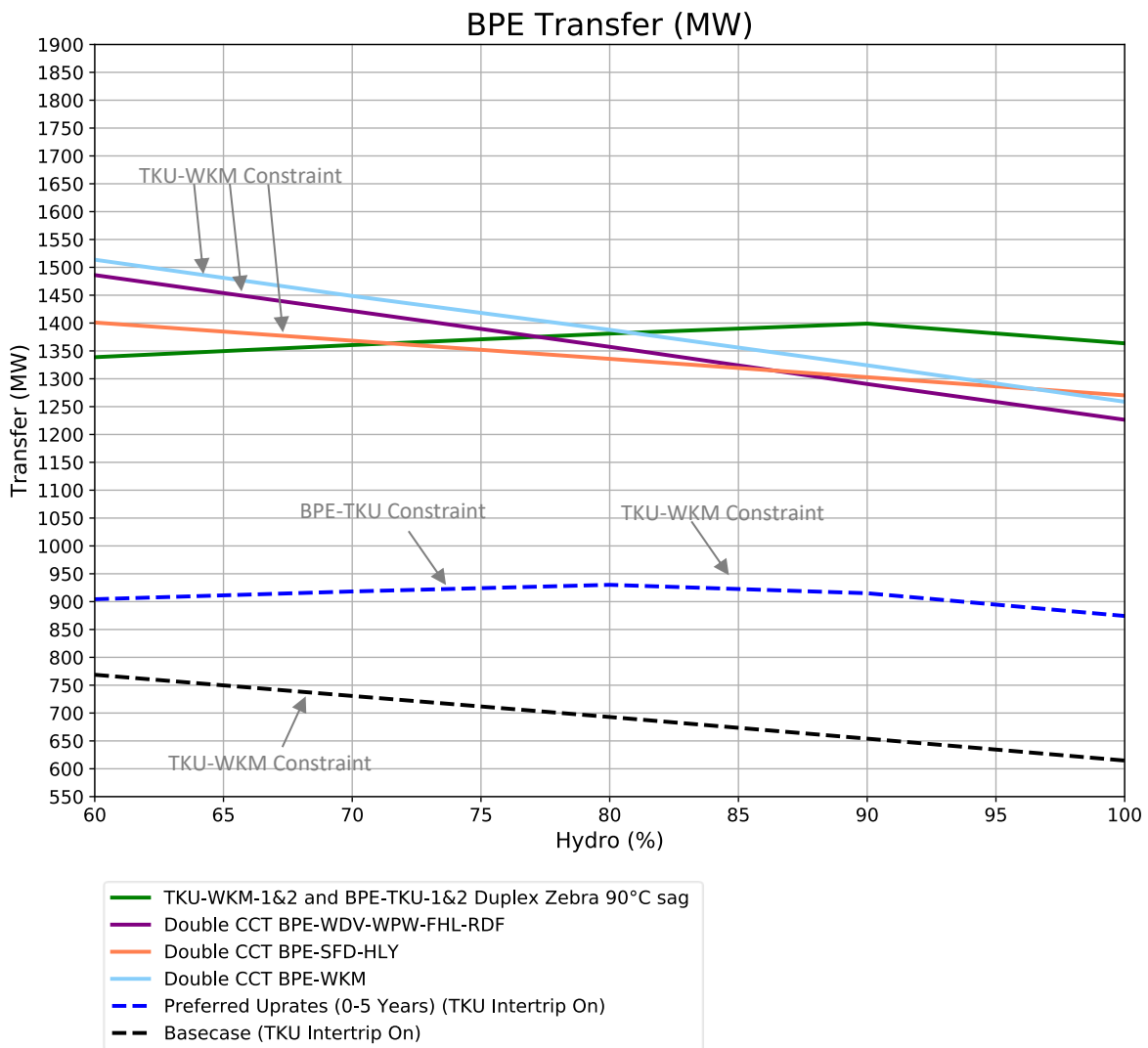

Figure 32: Option 17, 18 and 19 transfer limits

The constraints for the new line options are shown in Figure 33. It should be noted that Option 18, a new 220 kV double circuit duplex line between Bunnythorpe and Redclyffe increases loading on the Wairakei Ring and this has limited Bunnythorpe transfer. A detailed assessment of different Wairakei Ring re-enforcement options has been completed in a separate scope of works for this MCP. However, some sensitivity studies are presented in section 6.6 to investigate the effect of Wairakei ring reinforcements on CNI transfer.

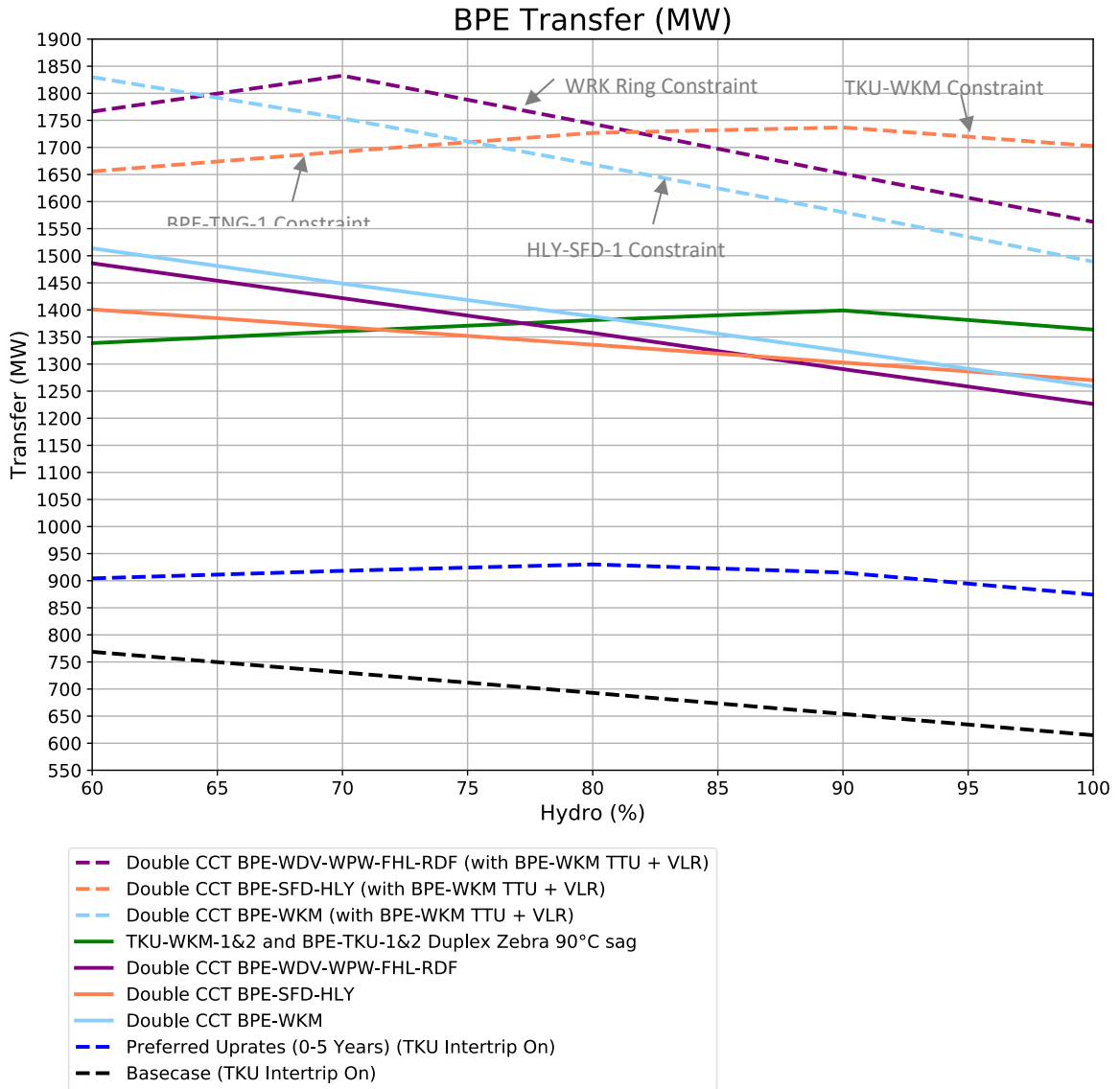

Figure 33: Option 17, 18 and 19 transfer limits with a 95°C TTU and VLR on the TKU-WKM and BPE-TKU 220 kV circuits

6 Additional analysis and sensitivity studies

6.1 Incremental upgrades - Duplex GoatAC 120°C sag

Based on the short term option and long term option analysis in sections 4 and 5 the incremental development path in Table 12 has been investigated. The work is split into four stages on the Tokaanu–Whakamaru 220 kV and Bunnythorpe–Tokaanu 220 kV circuits and sequenced to increase thermal transfer at each stage. The project dates are estimated and will be refined at a later date if these options are considered further.

After performing the analysis in sections 4 and 5 with duplex ZebraAC, information was received from the Transpower Lines team advising the blow out would be difficult to contain if ZebraAC was used to duplex the Bunnythorpe–Tokaanu and Tokaanu–Whakamaru 220 kV circuits. In this section GoatAC at 120°C sag has been used to duplex the lines and this conductor has a slightly higher resistance.

Figure 34 shows the transfer limit for stage 1 - 4 of the proposed incremental development path. The transfer limit has increased after each stage.

Table 12: Proposed CNI incremental development path

Stage	Upgrade/Update	Estimated Date
1	TTU Tokaanu–Whakamaru 220 kV Circuits, 95°C sag with VLR	2022-2024
2	TTU Bunnythorpe–Tokaanu 220 kV Circuits, 95°C sag with VLR	2024-2026
3	Duplex Tokaanu–Whakamaru 220 kV Circuits with GoatAC 120°C sag or similar	2026-2029
4	Duplex Bunnythorpe–Tokaanu 220 kV Circuits with GoatAC 120°C sag or similar	2029-2032

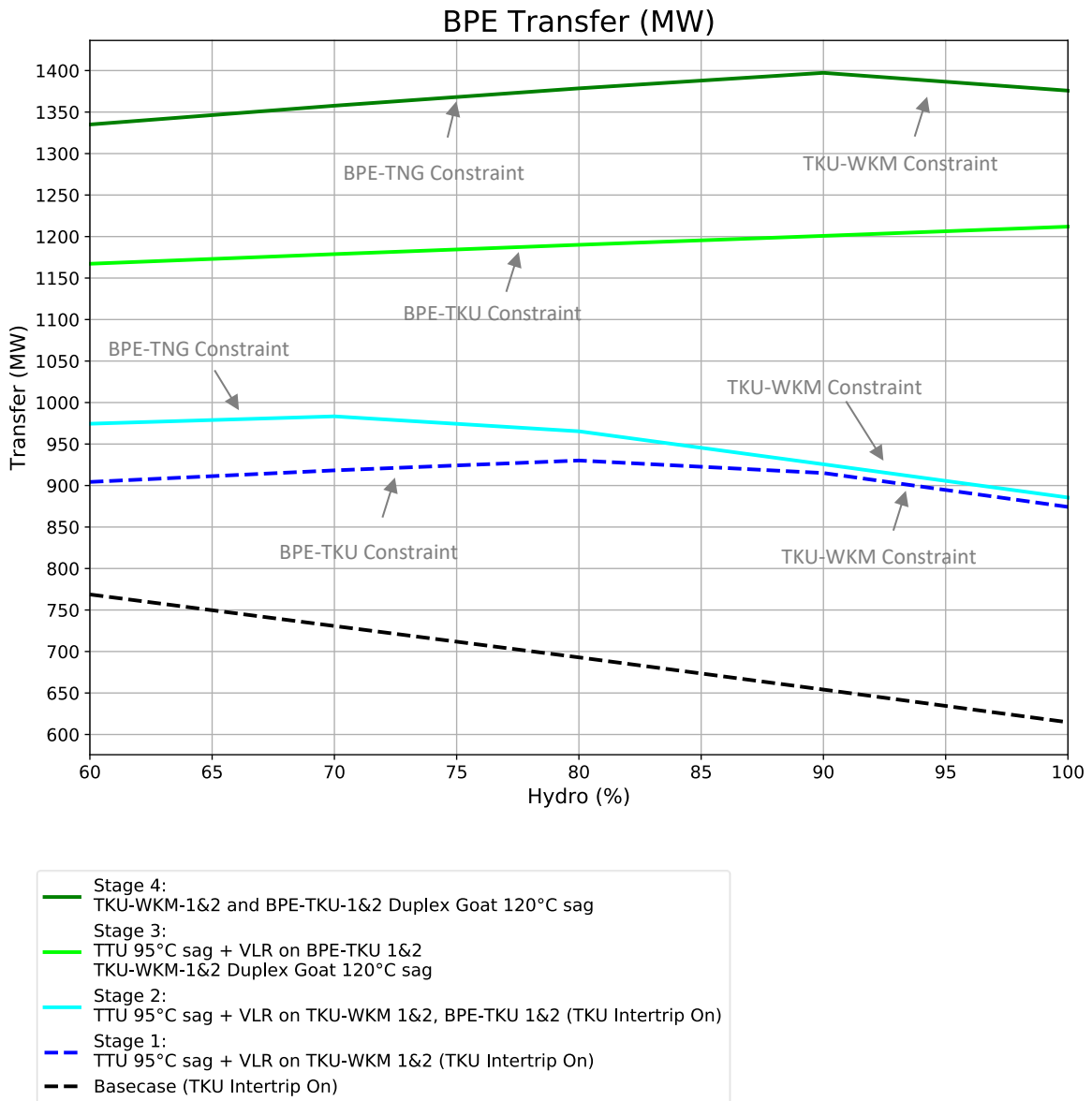

Figure 34: Thermal transfer increase for each stage of works on TKU–WKM 1&2 and BPE–TKU

Figure 34 shows the Bunnythorpe–Tangiwai 220 kV circuit is constraining transfer in upgrade Stage 2 and 4. To investigate the effect of the constraint a TTU was then applied to the Bunnythorpe–Tangiwai, Rangipo–Tangiwai and Rangipo–Wairakei 220 kV circuits, the new transfer limit is shown in Figure 35 and the TTU sag temperatures utilised are shown in Table 13. With the TTU applied the Bunnythorpe–Tangiwai 220 kV constraint is alleviated. The dashed trends in Figure 35 illustrate an increase in capacity. However, it is noticed the transfer capacity has not increased in Stage 3 (one series is directly on-top of the other), because the Bunnythorpe–Tokaanu circuits are the limiting constraint in that stage of the development path.

Table 13: TTUs applied to 220 kV circuits between Bunnythorpe and Wairakei

Circuit	Current Sag Temperature (°C)	TTU Sag Temperature (°C)
Bunnythorpe–Tangiwai–1	50	75
Rangipo–Tangiwai–1	50	75
Rangipo–Wairakei–1	80	95

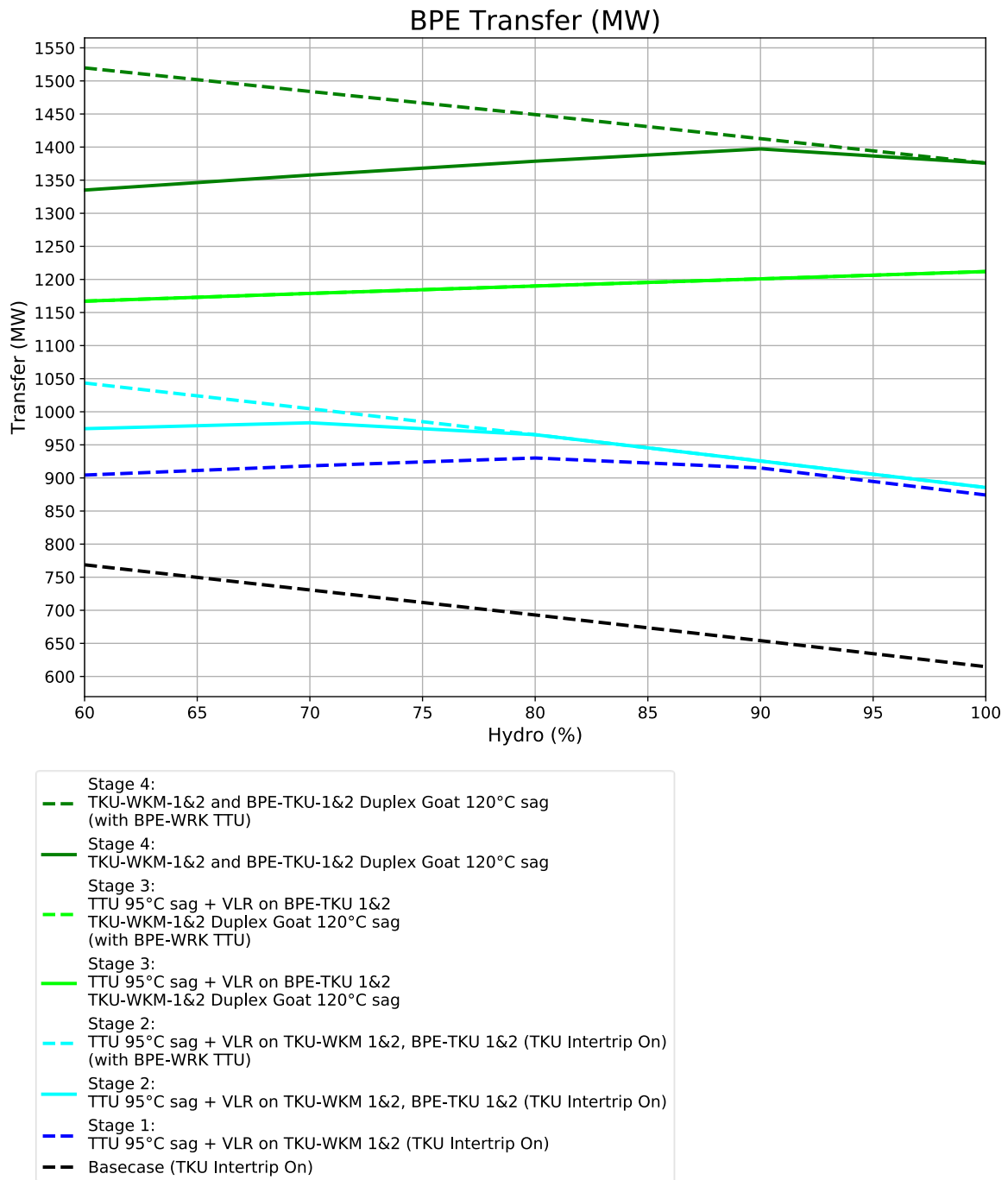

Figure 35: Thermal transfer increase for Stage 2 and Stage 4 with TTU on BPE–TNG, TNG–RPO, RPO–WRK

6.2 Tokaanu intertrip analysis

A comparison was completed with the Tokaanu Intertrip Scheme in service and out of service for the three different upgrade options shown in Table 14, the results can be seen in Figure 36. The upgrade options were chosen because they apply several different ratings and impedances across circuits which are affected by the intertrip scheme.

Table 14: TKU intertrip analysis

Number	Option Description	Highest Transfer Limit Achieved (TKU Intertrip Scheme in Service or Out of Service)
1	Preferred Short Term Option (0 – 5 Years). Tokaanu–Whakamaru TTU, Ongarue CB82 split, Huntly–Stratford protection uprate.	In Service
10	Duplex Tokaanu–Whakamaru to ZebraAC at 90°C sag	Out of Service
11	Duplex Bunnythorpe–Tokaanu and Tokaanu–Whakamaru to ZebraAC at 90°C sag	Out of Service

For Option 1 the transfer limit is higher with the scheme in service. This is because the rating of the Tokaanu–Whakamaru 220 kV circuits is not high enough to prevent them from being the limiting constraint, hence a contingency of a Tokaanu–Whakamaru 220 kV circuit will overload the remaining Tokaanu–Whakamaru 220 kV circuit.

The benefit of turning off the Tokaanu Intertrip Scheme is realised when both Tokaanu–Whakamaru and Bunnythorpe–Tokaanu 220 kV circuits are reconductored with duplex Zebra at 90°C. The result would be similar and more pronounced if both circuits were duplexed with Sulfur AAAC at 90°C due to the lower impedance and higher rating of the Sulfur conductor.

There is minimal benefit if the Tokaanu Intertrip Scheme is turned off with only Tokaanu–Whakamaru 220 kV circuits duplexed because the Bunnythorpe–Tokaanu 220 kV circuits limit thermal transfer.

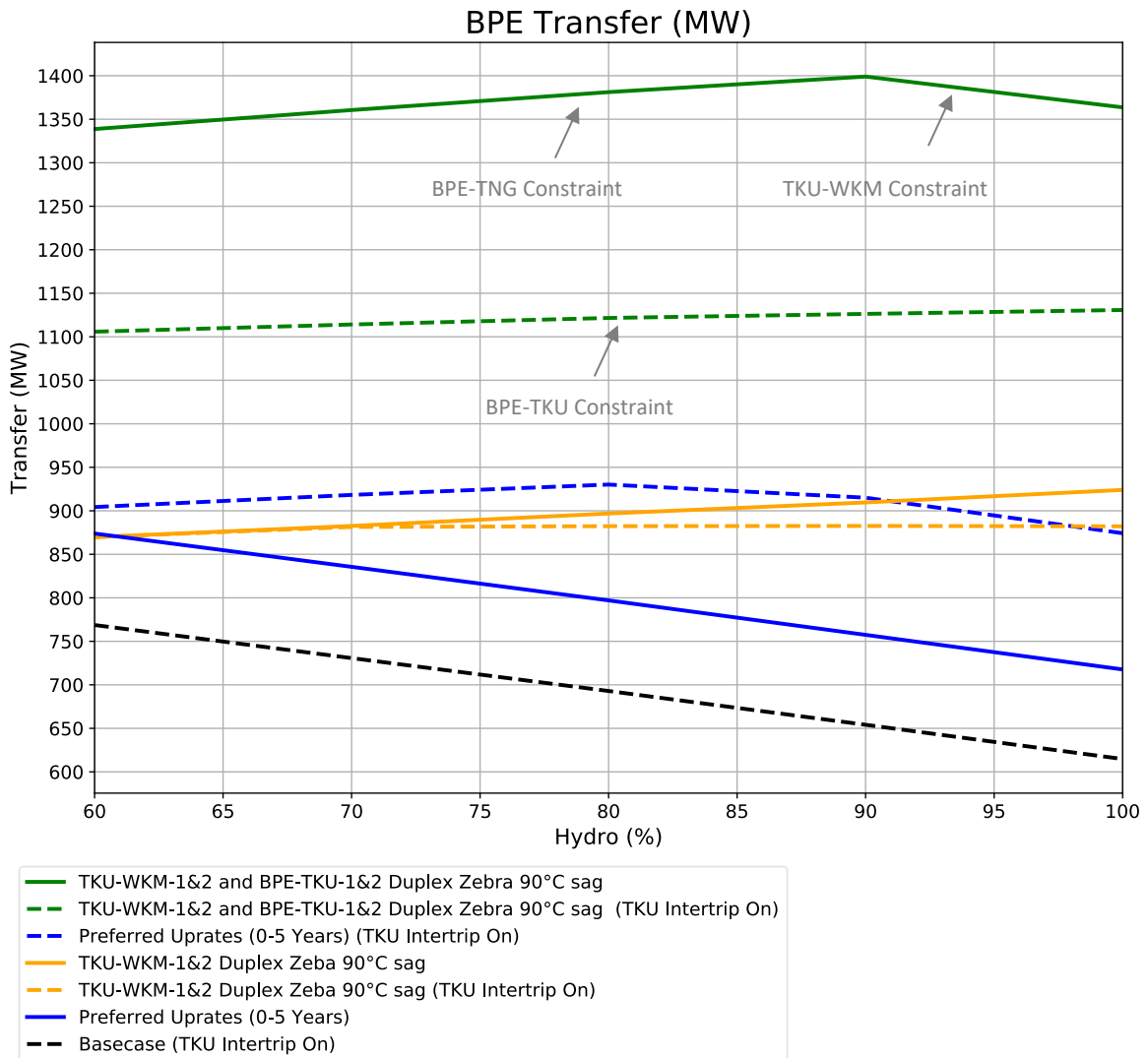

Figure 36: Three options with and without the TKU intertrip scheme in service

6.3 Huntly – Stratford protection limit analysis

As discussed in the short term option analysis the thermal rating of the Huntly–Stratford 220 kV circuit is limited by a protection relay. If the relay was upgraded the branch rating would increase to the conductor rating and this would yield an approximate 30% increase, 930A to 1292-1231A. As noted at the start of section 5, the Huntly–Stratford protection upgrade was assumed to be complete for the analysis described in this report.

To confirm the validity of this assumption, simulations were completed with and without the protection upgrade in place, the results can be seen in Figure 37. The two dashed series represent simulations without the protection upgrade and it is clear the transfer limit is reduced in both options.

- When both Tokaanu–Whakamaru and Bunnythorpe–Tokaanu are duplexed with ZebraAC at 90°C sag, the Huntly–Stratford branch constraint causes a large reduction in the transfer limit. The limiting constraint is a contingency of Stratford–Taumarunui overloading Huntly–Stratford.

- When just the Tokaanu–Whakamaru circuits are duplexed with ZebraAC at 90°C sag the Huntly–Stratford branch constraint causes a decrease in transfer limit. The limiting constraint becomes a contingency of Stratford–Taumarunui overloading Huntly–Stratford or a contingency of a Tokaanu–Whakamaru circuit overloading the remaining Tokaanu–Whakamaru circuit.

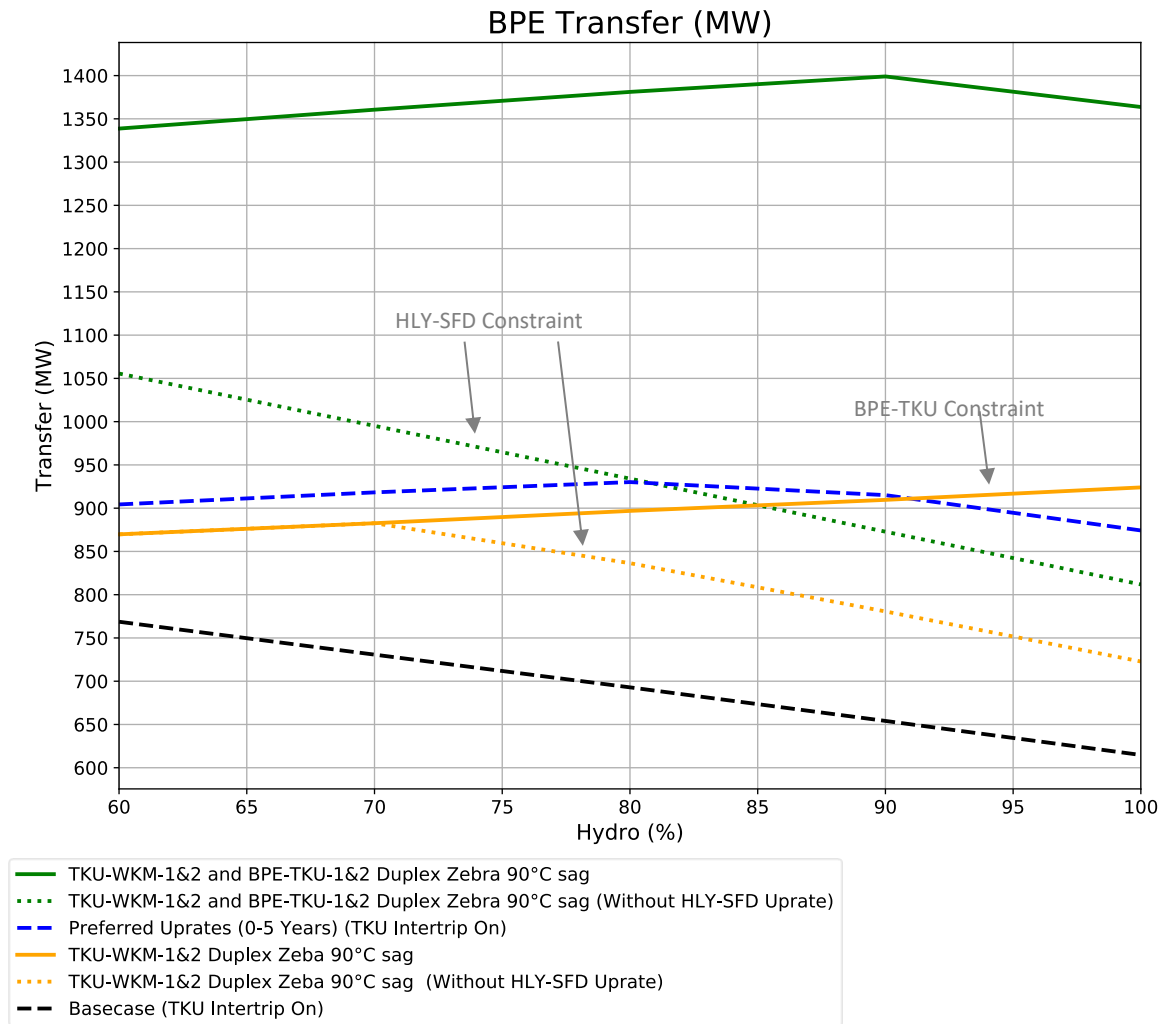

Figure 37: Transfer limit with and without the Huntly–Stratford protection upgrade

6.4 Bunnythorpe – Tokaanu 220 kV duplex sensitivity

The transfer limit has been calculated with the preferred short term uprate option⁴ and the Bunnythorpe–Tokaanu 220 kV circuits duplexed with ZebraAC at 90°C sag. This represents a scenario where a TTU/VLR is completed first on the Tokaanu–Whakamaru 220 kV circuits and duplexing is performed in future.

Figure 38 shows the transfer limit has decreased when compared to the preferred short term uprate option. The limiting constraint is a contingency of one Tokaanu–Whakamaru 220 kV circuit overloading the remaining Tokaanu–Whakamaru 220 kV circuit. A reduction in transfer limit after duplexing Bunnythorpe-Tokaanu is not ideal. Based on this result the incremental upgrade path presented in section 6.1 is preferred.

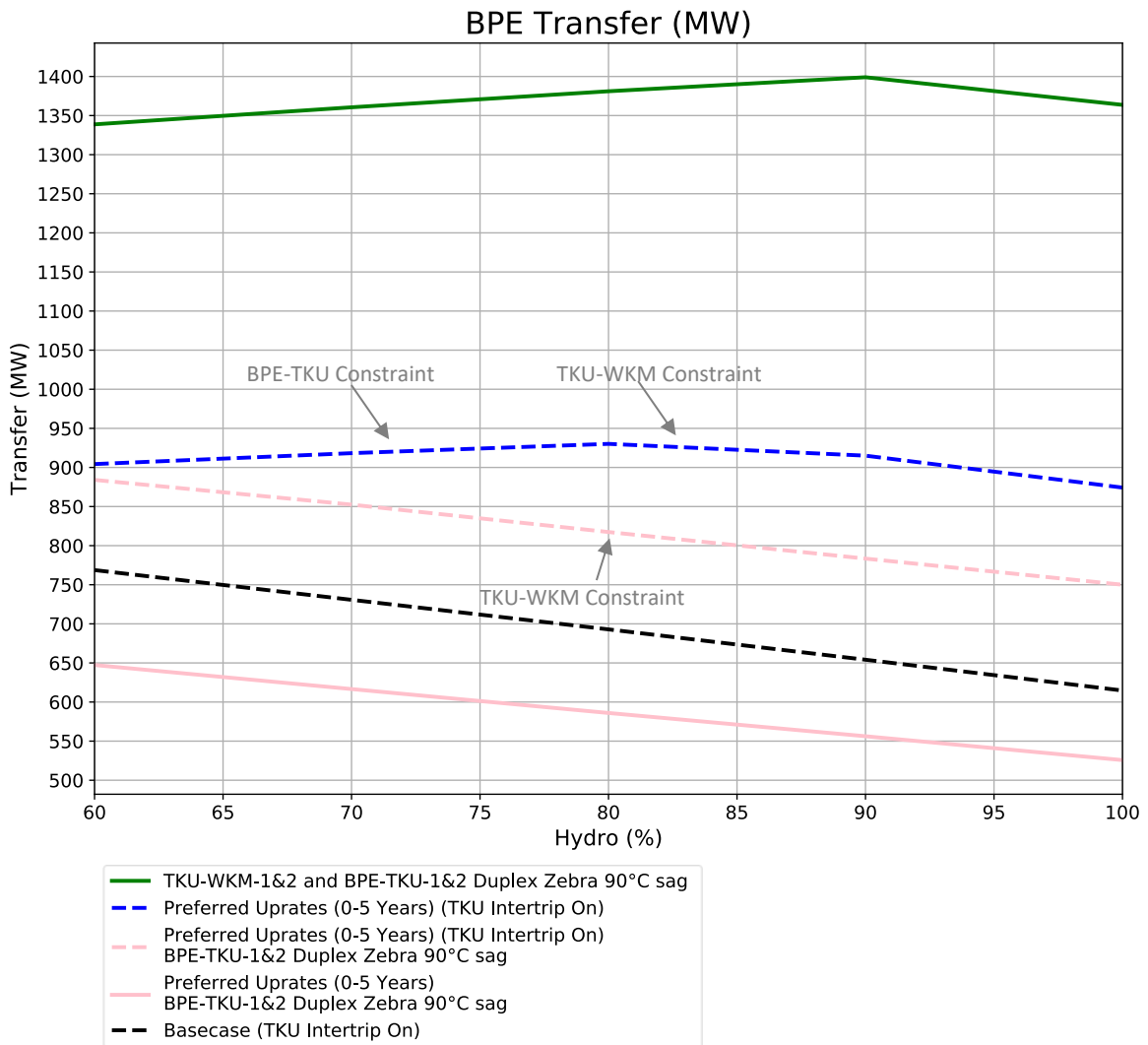

Figure 38: Duplexing post 95°C TTU on the Tokaanu–Whakamaru 220 kV circuits

⁴ Tactical Thermal Uprate (TTU) 95°C on the Tokaanu–Whakamaru 220 kV circuits with Variable Line Rating (VLR). Huntly–Stratford 220 kV protection upgrade has been completed and a 110 kV system split at Ongarue.

6.5 Tokaanu bus sensitivity study

A sensitivity study has been completed for Option 17. For this option a new 220 kV double Circuit line is created between Bunnythorpe and Whakamaru, but this time both circuits have been connected to the existing Tokaanu 220 kV busbar. The option is described as follows:

- New 220kV double circuit duplex lines, Bunnythorpe–Tokaanu and Tokaanu–Whakamaru duplex Sulfur AAAC at 90°C Sag

Figure 39 shows the simulation result compared against Option 17 and it’s clear the transfer limit has not increased.

With the new double circuit connected via the Tokaanu 220 kV busbar the net power flow did not change between the Bunnythorpe 220 kV busbar and Whakamaru 220 kV busbar. However, it was noticed the flow on the existing Tokaanu–Whakamaru 220 kV circuits decreased because the new Tokaanu–Whakamaru duplex Sulfur line provides a lower impedance path.

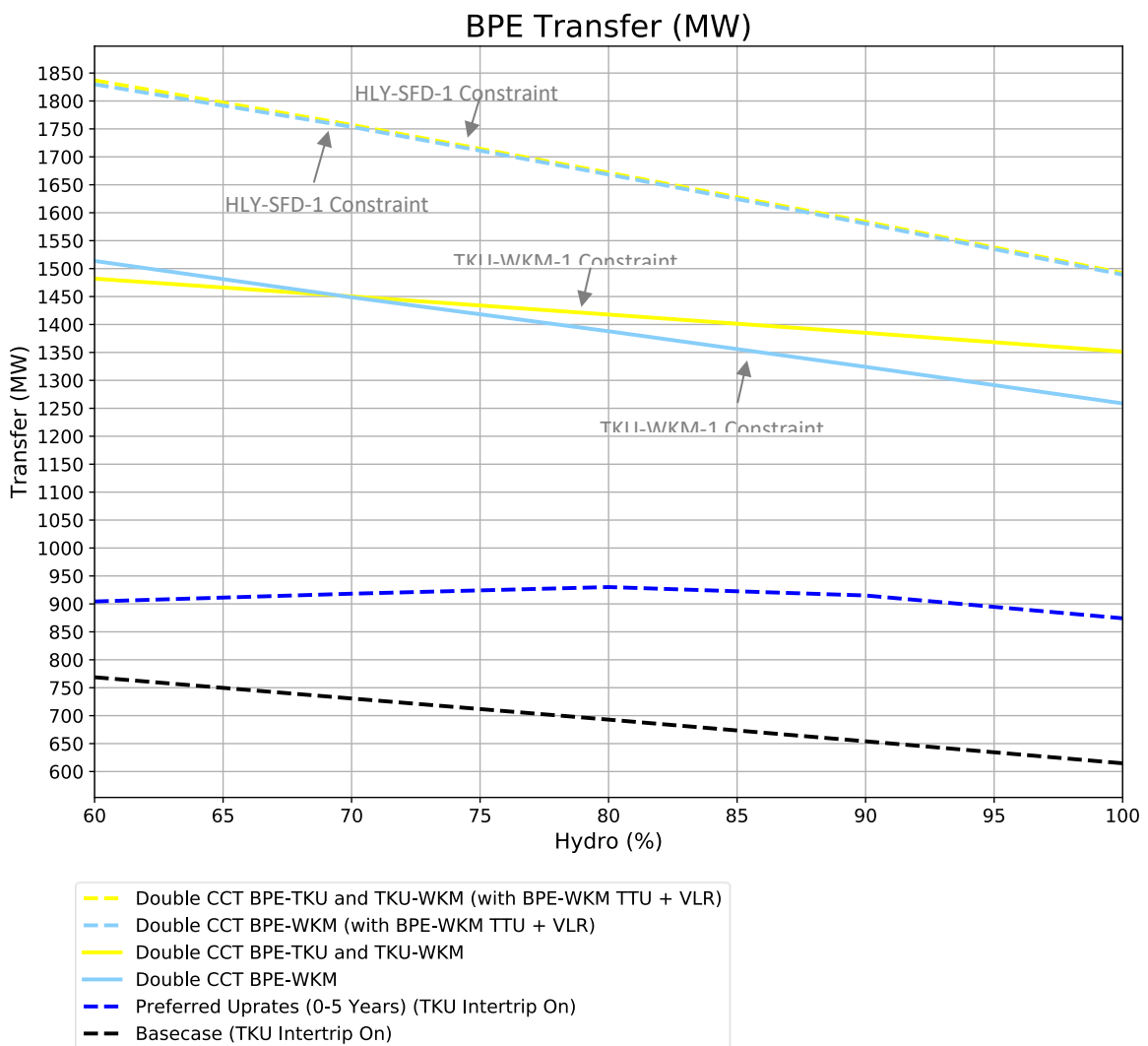

Figure 39: New 220 kV double circuit duplex line options between BPE and WKM with a 95°C TTU and VLR on the existing TKU-WKM and BPE-TKU 220 kV circuits

6.6 Wairakei ring sensitivity study

As explained in section 5.6 detailed analysis of Wairakei Ring re-enforcement options has been completed in a separate workstream for this MCP. For completeness, a sensitivity study has been performed for Option 18 to assess the change in CNI transfer level when Wairakei Ring constraints are alleviated.

In Option 18 a new 220 kV double circuit line is created between Bunnythorpe and Redclyffe and this increased north flow through the Wairakei Ring which then constrained Bunnythorpe Transfer. To be specific a contingency of the Te Mihi–Whakamaru 220 kV circuit could overload the Whakamaru–Wairakei 220 kV circuit or Ohakuri–Wairakei 220 kV circuit. The following Wairakei ring reinforcements were applied, and the study repeated:

- Addition of a New 220kV Double circuit duplex Line between WKM and WRK, duplex Sulfur AAC at 90°C sag. This will replace the existing WKM-WRK-A line.
- Duplex of the existing WKM-WRK 220 kV circuit with GoatAC at 120°C sag

These scenarios have been used to investigate future constraints which may develop if investment is made on the Wairakei Ring and its through capacity is increased. In this situation the question is posed - If Wairakei Ring constraints are alleviated would CNI constraints then limit Bunnythorpe transfer or would the 220 kV circuits between Wairakei and Redclyffe limit transfer?

Loading on the Wairakei–Redclyffe 220 kV circuits is pertinent due to the planned construction of Tauhara B Geothermal Power Station (≈150 MW) and Harapaki Wind Farm (≈176 MW), these power stations are planning to connect on the Wairakei–Redclyffe 220 kV circuit.

The transfer limits for the two sensitivity studies listed above, a new 220 kV Double circuit duplex Line and reconductoring of the Whakamaru-Wairakei-A line are shown in Figure 40 and Figure 41 respectively. The following points of interest are noted:

- The transfer limit was first calculated without a TTU and VLR on Tokaanu–Whakamaru 220 kV and Bunnythorpe–Tokaanu 220 kV circuits. It was thought that building a new line or duplexing may shift a significant amount of power off the existing Bunnythorpe–Whakamaru lines. This did not occur and Bunnythorpe transfer was limited by the Tokaanu–Whakamaru 220 kV circuits, this is shown by the 'lime coloured trends' in Figure 40 and Figure 41. These trends are lower than those produced in section 5.6 (the dashed purple trends). Therefore, both options require the circuit rating to be increased on Bunnythorpe–Whakamaru 220 kV circuits and the preferred method is a TTU with VLR.
- When a TTU and VLR is applied on the Tokaanu–Whakamaru 220 kV and Bunnythorpe–Tokaanu 220 kV circuits the transfer limit increases (shown by the red and light blue coloured trends in Figure 40 and Figure 41).
 - Whether overloading of the Tokaanu–Whakamaru 220 kV circuits or the Tauhara B–Wairakei 220 kV circuit occurs first is dependent on the amount of generation dispatched at Tauhara B and Harapaki Wind Farm. To illustrate this Harapaki was dispatched at full output (light blue trend) and 50% output (red trend). When dispatched at full output overloading of the Tauhara B–Wairakei 220 kV circuit limited Bunnythorpe transfer.
- In both scenarios (Figure 40 and Figure 41) the overloading of the Tokaanu–Whakamaru 220 kV circuits or Tauhara B–Wairakei 220 kV occurred before overloading of the Wairakei Ring Circuits, i.e. Wairakei–Whakamaru, Ohakuri–Whakamaru, Atiamuri–Whakamaru.

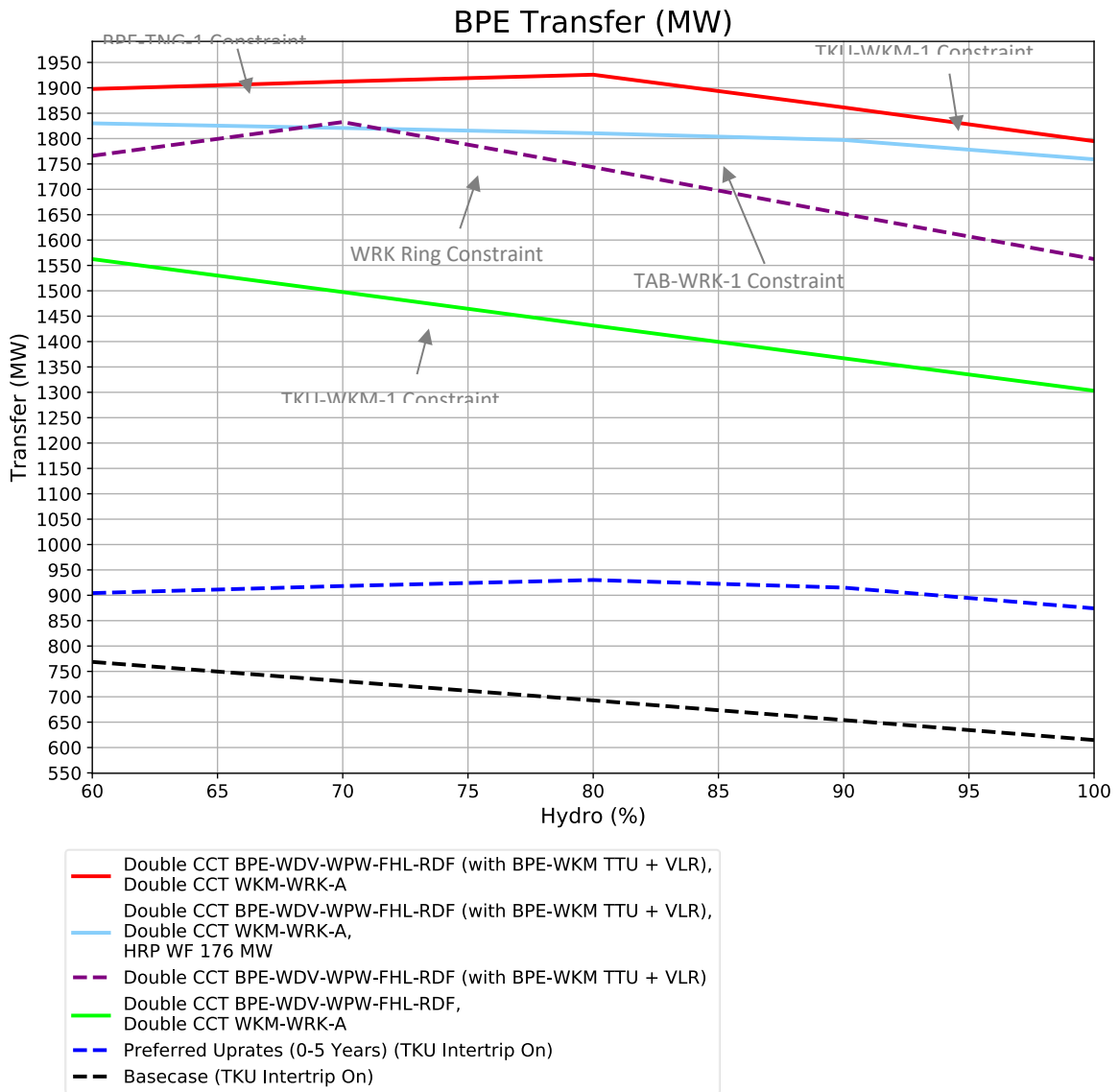

Figure 40: Wairakei Ring sensitivity study, Option 18 + new double circuit WKM-WRK-A Line

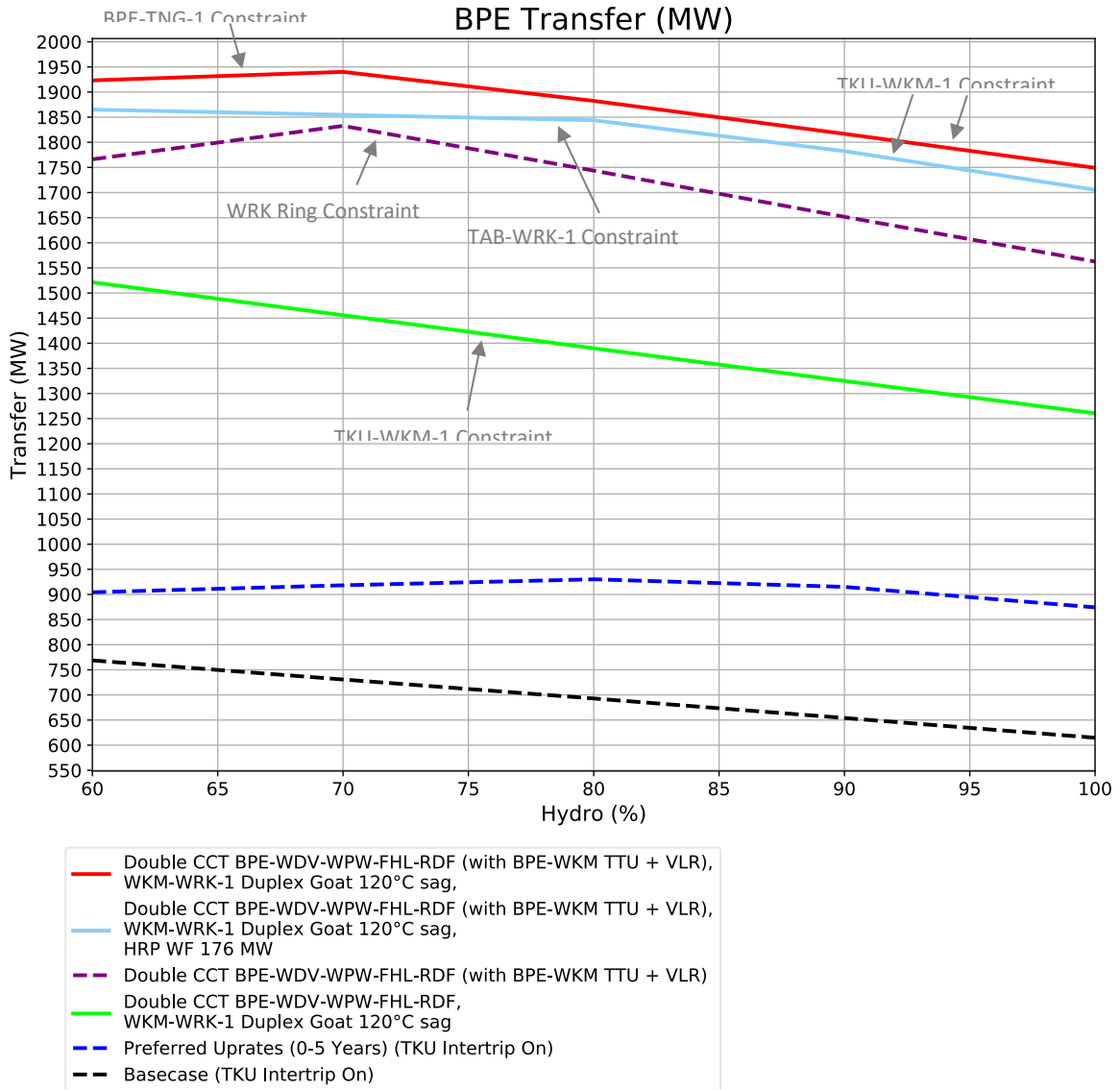

Figure 41: Wairakei Ring sensitivity study, Option 18 + duplex existing WKM-WRK 220 kV circuit

7 Conclusion

Short term options and long term options have been assessed to increase the transfer limit north of Bunnythorpe.

Short Term Option Analysis Results

Short term options were assessed with the goal in mind to identify any “quick wins” that exist. It is expected the options could be implemented in 0-5 years. The following combination of preferred upgrades has been identified and these increased the transfer limit 145 - 285 MW in the study scenarios:

- Tokaanu–Whakamaru 220 kV circuits with a 95°C TTU and VLR
- The Huntly–Stratford 220 kV protection limit removed
- A 110 kV system split at Ongarue

Shortly after completing the analysis, lab test information was provided by the Transpower lines team which stated 95°C is the most credible sag temperature for a TTU on the Tokaanu–Whakamaru 220 kV circuits. There is some doubt a TTU at 120°C would be compliant with recent grease migration studies and environmental considerations.

Options involving implementation of an SPS, bussing of CNI circuits and installation of reactors were investigated but ultimately ruled out due to less capacity gain or being technically infeasible.

Long Term Option Analysis Results

An assessment of long-term options has been performed; it is assumed the long term options could be implemented in the next 20 years to increase thermal transfer through the Bunnythorpe region.

The transfer limit increase for various options is shown in Table 15. The highest transfer limits were achieved when a new 220 kV double circuit duplex line was built with duplex Sulfur AAAC at 90°C sag and a 95°C TTU with VLR was applied to the existing Tokaanu–Whakamaru and Bunnythorpe–Tokaanu 220 kV circuits. This was Option 17, 18 and 19.

The next highest transfer limits were achieved with Option 11 and 13 when the existing circuits between Bunnythorpe and Whakamaru were reconductored with duplex ZebraAC or duplex Sulfur AAAC. Reconductoring with duplex GoatAC gave a similar average transfer level (\approx 680 MW).

Table 15: Transfer limit increase for different options (MW)

Option No.	Hydro (%)					Average
	60	70	80	90	100	
Option 18	995	1100	1050	1000	950	1020
Option 17	1060	1025	975	925	875	1010
Option 19	885	960	1035	1085	1090	970
Option 13	600	660	720	775	790	710
Option 11	520	580	640	700	760	640
Option 15	360	345	330	315	300	330
0-5 Year Preferred Short Term Option	135	190	235	260	260	215
Basecase	0	0	0	0	0	0

Other following information of note has been identified in the analysis:

- Option 14, constructing a new substation and new transmission line near Rangipo and bussing the existing circuits provided significantly less benefit than Options 11 and 13.
- Option 15, constructing a new line between Bunnythorpe and Whakamaru 220 kV substations provided significantly less benefit than Option 11 and 13. This is because no other changes were made to the existing grid and the Tokaanu-Whakamaru 220 kV circuits overloaded and limited transfer.
- The effect of the Tokaanu Intertrip Scheme was investigated for different long-term options. It is recommended to disable the scheme if Tokaanu–Whakamaru and Bunnythorpe–Tokaanu are duplexed with ZebraAC at 90°C sag, Sulfur AAAC at 90°C sag or GoatAC at 120°C.
- The effect of the Huntly–Stratford protection upgrade was investigated. Previously it has been thought that if the Tokaanu–Whakamaru circuits are duplexed enough flow might be shifted off Huntly–Stratford to prevent the circuit overloading hence removing the requirement to complete the protection upgrade work. Simulations were completed with and without the protection upgrade and this has shown the protection upgrade significantly increases the transfer limit.

For Option 18, two Wairakei Ring sensitivity studies were performed where the Whakamaru–Wairakei 220 kV A line was replaced with a double circuit duplex line or reconducted with duplex GoatAC at 120°C sag. The A line connects at Ohakuri and Atiamuri 220 kV substations and at times can limit transfer through the Wairakei Ring. In this assessment reinforcing the Wairakei ring increased the Bunnythorpe transfer limit 150 - 250 MW and this was dependent on dispatch of Harapaki Wind Farm and Tauhara B Geothermal Power Station.

8 References

Transpower. (2021). *Long List Consultation*. Wellington: Transpower.

Appendix A Monitored circuits

Circuit

BPE-MTR-1

BPE-TKU-1

BPE-TKU-2

BPE-TNG-1

HLY-SFD-1

HLY-TWH-1

RPO-TNG-1

RPO-WRK-1

TKU-WKM-1

TKU-WKM-2

TMN-TWH-1

Appendix B TTU and VLR ratings

The tables in below contain the ratings used in DigSILENT PowerFactory for the Tokaanu–Whakamaru 220 kV circuits when TTU and VLR was applied for 80°C, 95°C and 120°C.

B.1 Ratings TKU-WKM-1 80°C VLR (MIN, MAX, AVG)

Value	Winter	Shoulder	Summer
MIN	0.8847041	0.8281934	0.7981977
MAX	1.142329	1.142329	1.085486
AVG	1.022	0.9837056	0.9380477
Seasonal Branch	0.88	0.845	0.807
Season Conductor	0.88	0.845	0.807

B.2 Ratings TKU-WKM-2 80°C VLR (MIN, MAX, AVG)

Value	Winter	Shoulder	Summer
MIN	0.8740785	0.8179319	0.7876939
MAX	1.12852	1.124243	1.073663
AVG	1.012926	0.979554	0.927469
Seasonal Branch	0.88	0.845	0.807
Season Conductor	0.88	0.845	0.807

B.3 Ratings TKU-WKM-1 95°C VLR (MIN, MAX, AVG)

Value	Winter	Shoulder	Summer
MIN	0.9816	0.9343	0.914
MAX	1.253	1.253	1.1888
AVG	1.1121	1.0811	1.0386
Seasonal Branch	0.968	0.937	0.905
Season Conductor	0.968	0.937	0.905

B.4 Ratings TKU-WKM-2 95°C VLR (MIN, MAX, AVG)

Value	Winter	Shoulder	Summer
MIN	0.9816	0.9343	0.914
MAX	1.253	1.253	1.1888
AVG	1.1121	1.0811	1.0386
Seasonal Branch	0.968	0.937	0.905
Season Conductor	0.968	0.937	0.905

B.5 Ratings TKU-WKM-1 120°C VLR (MIN, MAX, AVG)

Value	Winter	Shoulder	Summer
MIN	1.1435	1.1055	1.0959
MAX	1.4414	1.4414	1.3637
AVG	1.2658	1.2417	1.2053
Seasonal Branch	1.091	1.066	1.04
Season Conductor	1.091	1.066	1.04

B.6 Ratings TKU-WKM-2 120°C VLR (MIN, MAX, AVG)

Value	Winter	Shoulder	Summer
MIN	1.1215	1.0938	1.084
MAX	1.3618	1.4251	1.3455
AVG	1.2407	1.217	1.1874
Seasonal Branch	1.091	1.066	1.04
Season Conductor	1.091	1.066	1.04

B.7 Ratings BPE-TKU-1 95°C VLR (MIN, MAX, AVG)

Value	Winter	Shoulder	Summer
MIN	0.9810	0.9409	0.9368
MAX	1.2577	1.2577	1.1820
AVG	1.1251	1.0935	1.0469
Seasonal Branch	0.968	0.937	0.905
Season Conductor	0.968	0.937	0.905

B.8 Ratings BPE-TKU-2 95°C VLR (MIN, MAX, AVG)

Value	Winter	Shoulder	Summer
MIN	0.9812	0.9410	0.9376
MAX	1.2579	1.2579	1.1830
AVG	1.1253	1.0937	1.0473
Seasonal Branch	0.968	0.937	0.905

Appendix C Huntly - Stratford rating

This table shows the ratings used in DigSILENT PowerFactory for the Huntly–Stratford 220 kV circuit before and after the protection relay upgrade.

Before Protection Upgrade.

Value	Winter	Shoulder	Summer
Seasonal Branch	0.93	0.93	0.93
Season Conductor	1.292	1.262	1.231

After Protection Relay Upgrade - the branch rating is raised.

Value	Winter	Shoulder	Summer
Seasonal Branch	1.292	1.262	1.231
Season Conductor	1.292	1.262	1.231

Appendix D Generation dispatch

D.1 Generation dispatch values for winter and summer peak cases

Generator	Winter (MW)	Summer (MW)	Active Power Max (MW)
ANI-G1	9.3	5.7	12.5
ANI-G2	9.3	5.7	12.5
ARA-G1	20.0	27.0	27.0
ARA-G2	30.0	30.0	30.0
ARA-G3	30.0	30.0	30.0
ARI-G1	22.5	22.5	22.5
ARI-G2	22.5	22.5	22.5
ARI-G3	22.5	22.5	22.5
ARI-G4	22.5	22.5	22.5
ARI-G5	27.0	27.0	27.0
ARI-G6	27.0	27.0	27.0
ARI-G7	27.0	27.0	27.0
ARI-G8	27.0	27.0	27.0
ATI-G1	20.0	20.0	20.0
ATI-G2	20.0	20.0	20.0
ATI-G3	20.0	20.0	20.0
ATI-G4	20.0	20.0	20.0
EDG-GA	0.4	0.5	4.9
EDG-GB	0.4	0.5	4.9
GLN-G1	15.0	15.0	18.8
GLN-G2	15.0	15.0	18.8
GLN-G3	45.8	40.0	74.3
GLN-M1	2.0	2.0	3.4
HAY-C1	0.0	0.0	1.0
HAY-C10	0.0	0.0	1.0
HAY-C2	0.0	0.0	1.0
HAY-C3	0.0	0.0	1.0
HAY-C4	0.0	0.0	1.0
HAY-C7	0.0	0.0	1.0
HAY-C8	0.0	0.0	1.0
HAY-C9	0.0	0.0	1.0
HLY-UN1	0.0	0.0	0.0
HLY-UN2	0.0	0.0	0.0
HLY-UN4	0.0	0.0	0.0
HLY-UN5	390.0	0.0	400.0
HLY-UN6	50.0	0.0	50.0
JRD-G1	50.0	0.0	52.0
JRD-G2	50.0	0.0	52.0
KA24	6.2	5.1	9.0
KAG-G1	100.0	100.0	106.0
KIN-G1	19.0	19.0	39.6

KPI-G1	5.1	6.6	11.0
KPI-G2	5.1	6.6	12.5
KPO-G1	37.0	37.5	37.5
KPO-G2	37.0	37.5	37.5
KPO-G3	37.0	37.5	37.5
KTW-G6	9.0	18.0	18.0
KTW-G7	9.0	18.0	18.0
LMD-G1	7.0	5.6	7.7
LMD-G2	7.0	5.6	7.7
MAT-G1	40.0	40.0	40.0
MAT-G2	40.0	40.0	40.0
MHO-G1	25.8	17.3	27.0
MHO-G2	5.7	5.7	5.7
MHO-G3	0.0	5.7	5.7
MKE-G1	47.0	0.0	47.0
MKE-G2	47.0	0.0	47.0
MOK-G1	4.1	3.1	4.5
MOK-G10	36.9	28.2	45.6
MOK-G11	4.1	3.1	4.5
MOK-G12	4.1	3.1	4.5
MOK-G2	4.1	3.1	4.5
MOK-G21	4.1	3.1	4.5
MOK-G22	4.1	3.1	4.5
MOK-G3	7.2	5.5	8.2
MOK-G30	17.4	13.3	21.5
MOK-G31	7.2	5.5	8.2
MOK-G32	7.2	5.5	8.2
MOK-G41	6.1	4.7	7.3
MPA-G1	5.2	4.1	5.6
MTI-G1	36.0	36.0	36.0
MTI-G10	36.0	36.0	36.0
MTI-G2	36.0	36.0	36.0
MTI-G3	36.0	36.0	36.0
MTI-G4	36.0	36.0	36.0
MTI-G5	36.0	36.0	36.0
MTI-G6	36.0	36.0	36.0
MTI-G7	36.0	36.0	36.0
MTI-G8	36.0	36.0	36.0
MTI-G9	36.0	36.0	36.0
NAP-G1	135.0	0.0	138.0
NBG	31.4	12.4	31.6
NGA-G1	4.5	1.8	5.0
NGA-G2	4.5	1.8	5.0
NGA-G3	15.5	6.1	15.8
NTM-G1	22.0	20.0	23.8
NTM-G2	22.0	20.0	23.8

NTM-G3	22.0	20.0	23.8
NTM-G4	22.0	20.0	23.8
OHK-G1	28.0	28.0	28.0
OHK-G2	28.0	28.0	28.0
OHK-G3	28.0	28.0	28.0
OHK-G4	28.0	28.0	28.0
OKI-UN1	30.0	30.0	48.0
OKI-UN2	30.0	30.0	46.0
OTC-CCGT	0.0	0.0	0.0
PPI-G1	50.0	38.0	55.0
PRI-G4	22.0	23.6	23.6
PRI-G5	22.0	23.6	23.6
PTA-G1	11.2	11.2	11.2
PTA-G2	11.2	11.2	11.2
PTA-G3	11.2	11.2	11.2
RHI-G1	8.5	6.7	9.7
RHI-G2	8.5	6.7	9.7
RKA-G1	13.8	10.0	15.0
RKA-G2	4.5	3.3	5.0
RKA-G3	4.5	3.3	5.0
RKA-G4	4.5	3.3	5.0
RKA-G5	4.5	3.3	5.0
RPO-G5	65.0	65.0	65.0
RPO-G6	65.0	65.0	65.0
SFD-G21	100.0	0.0	110.0
SFD-G22	100.0	0.0	110.0
SPL-CCGT	0.0	0.0	0.0
SWN-GE101	0.0	0.0	0.0
SWN-GE102	0.0	0.0	0.0
SWN-GE105	0.0	0.0	0.0
SWN-STG103	0.0	0.0	0.0
T/A_1	0.0	0.0	0.0
T/A_2	11.2	9.2	16.0
T/A_3	6.7	5.4	9.5
TAA-G1	10.9	7.6	14.9
TAA-G2	10.9	7.6	14.9
TAOM	24.3	22.5	24.3
THI-G1	91.0	83.0	91.9
THI-G2	91.0	83.0	91.9
TKU-G1	60.0	60.0	60.0
TKU-G2	60.0	60.0	60.0
TKU-G3	60.0	60.0	60.0
TKU-G4	60.0	60.0	60.0
TOPP1	17.0	13.9	23.8
TRA-G1	161.3	0.0	177.4
TRC	31.1	28.6	50.0

TUI-G1	20.0	20.0	20.0
TUI-G2	20.0	20.0	20.0
TUI-G3	20.0	20.0	20.0
WAA-G1	4.6	5.4	10.0
WAA-G10	13.0	15.2	28.6
WAA-G2	4.6	5.4	10.0
WAA-G3	4.6	5.4	10.0
WAA-G4	4.6	5.4	10.0
WHE-G1	12.0	12.0	12.0
WHE-G2	12.0	12.0	12.0
WHI-G1	0.0	0.0	0.0
WHI-G2	0.0	0.0	0.0
WHI-G3	0.0	0.0	0.0
WKM-G1	31.0	31.0	31.0
WKM-G2	31.0	31.0	31.0
WKM-G3	31.0	31.0	31.0
WKM-G4	31.0	31.0	31.0
WPA-G1	18.8	18.8	18.8
WPA-G2	18.8	18.8	18.8
WPA-G3	18.8	18.8	18.8
WRK-UN1	10.5	10.5	12.4
WRK-UN10	10.5	10.5	12.4
WRK-UN11	32.0	29.0	33.3
WRK-UN12	32.0	29.0	33.3
WRK-UN13	32.0	29.0	33.3
WRK-UN15	4.0	4.0	4.2
WRK-UN16	7.0	7.0	10.0
WRK-UN4	10.5	10.5	12.4
WRK-UN7	10.5	10.5	12.4
WRK-UN8	10.5	10.5	12.4
WRK-UN9	10.5	10.5	12.4

Appendix E Line parameters

Transmission line parameters used for different analysis options

Rating #	Circuit	Conductor	R1 [ohm]	X1 [ohm]	C1 [uF]	R0 [ohm]	X0 [ohm]	C0 [uF]	Length [m]	Winter [kA]	Shoulder [kA]	Summer [kA]
1	BPE-TKU-1	Duplex ZebraAC 90°C	5.265	51.196	1.852	29.384	176.648	1.043	162914	2274	2196	2114
2	BPE-TKU-2	Duplex ZebraAC 90°C	5.256	50.445	1.873	29.331	177.650	1.039	162621	2274	2196	2114
3	TKU-WKM-1	Duplex ZebraAC 90°C	2.195	21.297	0.773	12.248	73.717	0.442	67907	2274	2196	2114
4	TKU-WKM-2	Duplex ZebraAC 90°C	2.207	21.180	0.786	12.315	74.590	0.436	68280	2274	2196	2114
5	BPE-RPO-1	Duplex ZebraAC 90°C	4.649	45.206	1.635	25.946	155.980	0.921	143853	2274	2196	2114
6	BPE-RPO-1	Duplex ZebraAC 90°C	4.641	44.543	1.654	25.899	156.865	0.917	143595	2274	2196	2114
7	RPO-TKU-1	GoatAC 80°C (Existing)	1.709	8.247	0.161	4.552	22.920	0.099	19061	880	845	807
8	RPO-TKU-2	GoatAC 80°C (Existing)	1.440	6.890	0.137	3.835	19.353	0.087	19027	880	845	807
9	RPO-WKM-1	Duplex Sulfur AAAC 90°C	2.560	33.983	1.403	19.611	84.701	0.696	115175	2896	2797	2694
10	TKU-WKM-1	Duplex Sulfur AAAC 90°C	1.509	20.034	0.827	11.562	49.934	0.410	67900	2896	2797	2694
11	TKU-WKM-2	Duplex Sulfur AAAC 90°C	1.518	20.152	0.832	11.630	50.228	0.413	68300	2896	2797	2694
12	BPE-TKU 1	Duplex Sulfur AAAC 90°C	3.622	48.069	1.985	27.740	119.808	0.985	162914	2896	2797	2694
13	BPE-TKU 2	Duplex Sulfur AAAC 90°C	3.615	47.982	1.982	27.690	119.593	0.983	162621	2896	2797	2694
14	BPE-WKM-1	Duplex Sulfur AAAC 90°C	6.197	82.250	3.397	47.466	205.003	1.685	278760	2896	2797	2694
15	BPE-TKU-1	180°C Dublin ACCC 8/5.53	8.700	70.453	1.365	32.818	194.022	0.875	162914	1751	1727	1704
16	BPE-TKU-2	180°C Dublin ACCC 8/5.53	8.684	70.327	1.363	32.759	193.674	0.873	162621	1751	1727	1704
17	TKU-WKM-1	180°C Dublin ACCC 8/5.53	3.626	29.367	0.569	13.679	80.873	0.365	67907	1751	1727	1704
18	TKU-WKM-2	180°C Dublin ACCC 8/5.53	3.646	29.528	0.572	13.755	81.318	0.367	68280	1751	1727	1704
19	BPE-WKM-2	Duplex Sulfur AAAC 90°C	6.197	82.250	3.397	47.466	205.003	1.685	278760	2896	2797	2694
20	SFD-TMN-2	Duplex Sulfur AAAC 90°C	7.530	45.256	0.995	24.054	137.200	0.498	111120	2896	2797	2694
21	TMN-HLY-2	Duplex Sulfur AAAC 90°C	11.390	68.455	1.505	36.384	207.529	0.753	168080	2896	2797	2694
22	BPE-WDV-3 and 4	Duplex Sulfur AAAC 90°C	0.489	6.686	0.260	3.746	19.148	0.135	22000	2896	2797	2694
23	DVK-WDV-1 and 2	Duplex Sulfur AAAC 90°C	0.489	6.686	0.260	3.746	19.148	0.135	22000	2896	2797	2694
24	DVK-WPW-1 and 2	Duplex Sulfur AAAC 90°C	1.067	14.588	0.567	8.173	41.778	0.293	48000	2896	2797	2694
25	FHL-WPW-1 and 2	Duplex Sulfur AAAC 90°C	1.000	13.677	0.532	7.662	39.167	0.275	45000	2896	2797	2694

26	FHL-RDF-1 and 2	Duplex Sulfur AAAC 90°C	0.178	2.431	0.095	1.362	6.963	0.049	8000	2896	2797	2694
27	BPE-SFD-1	Duplex Sulfur AAAC 90°C	3.7124	48.5454	2.06637	28.4358	184.8789	0.92348	167000	2896	2797	2694
28	BPE-SFD-2	Duplex Sulfur AAAC 90°C	3.7124	48.5454	2.06637	28.4358	184.8789	0.92348	167000	2896	2797	2694
29	HLY-SFD-2	Duplex Sulfur AAAC 90°C	6.0021	78.4866	3.34084	45.974	298.906	1.49305	270000	2896	2797	2694
30	HLY-SFD-3	Duplex Sulfur AAAC 90°C	6.0021	78.4866	3.34084	45.974	298.906	1.49305	270000	2896	2797	2694

The parameters used for each reinforcement option. With regards to the rating number in the first table of Appendix E.

Option Number	Description	Rating # Used
10	Duplex Tokaanu–Whakamaru to ZebraAC at 90°C sag and disable Tokaanu-CB129 intertrip scheme.	3,4
11	Duplex Bunnythorpe–Tokaanu and Tokaanu–Whakamaru to ZebraAC at 90°C sag and disable Tokaanu–CB129 intertrip scheme.	1,2,3,4
13	Duplex Tokaanu–Whakamaru to Sulfur AAAC at 90°C sag and disable Tokaanu-CB129 intertrip scheme.	10,11
14	Duplex Bunnythorpe–Tokaanu and Tokaanu–Whakamaru to Sulfur AAAC at 90°C sag and disable Tokaanu-CB129 intertrip scheme.	10,11,12,13
12	Duplex Tokaanu–Whakamaru to ZebraAC at 90°C sag and disable Tokaanu-CB129 intertrip scheme. Bus 220 kV circuits near Rangipo, duplex Bunnythorpe–New Station line to ZebraAC at 90°C. Create a new line, Whakamaru–New Station with duplex Sulfur AAAC at 90°C sag.	3,4 5,6 7,8 9
15	New 220 kV Single Circuit Line, between Bunnythorpe and Whakamaru, duplex Sulfur AAAC at 90°C sag	14
16	Reconductor Bunnythorpe-Tokaanu and Tokaanu-Whakamaru with HTLS conductor at 180°C sag.	15,16,17,18
17	New 220 kV double circuit duplex line between Bunnythorpe–Whakamaru, duplex Sulfur AAAC at 90°C sag	14,19
18	New 220 kV double circuit duplex line between Bunnythorpe–Woodville–Waipawa–Fernhill–Redclyffe, duplex Sulfur AAAC at 90°C sag	22,23,24,25,26
19	New 220 kV double circuit duplex line between Bunnythorpe–Stratford–Huntly, duplex Sulfur AAAC at 90°C sag	27,28,29,30

Appendix B - Wairakei Ring Option Analysis Report

Wairakei Ring upgrade option Analysis

COPYRIGHT © 2023 TRANSPower NEW ZEALAND LIMITED. ALL RIGHTS RESERVED

This document is protected by copyright vested in Transpower New Zealand Limited (“Transpower”). No part of the document may be reproduced or transmitted in any form by any means including, without limitation, electronic, photocopying, recording or otherwise, without the prior written permission of Transpower. No information embodied in the documents which is not already in the public domain shall be communicated in any manner whatsoever to any third party without the prior written consent of Transpower. Any breach of the above obligations may be restrained by legal proceedings seeking remedies including injunctions, damages and costs.

LIMITATION OF LIABILITY/DISCLAIMER OF WARRANTY

This document is produced for internal use only and has not been approved for external release. Its conclusions are based on the information currently available to Transpower and may change as further information becomes available either internally or externally.

Table of contents

Executive Summary	83
1 Purpose of this document.....	86
2	
..... Background	
d	86
3	
..... Methodology and assumptions.....	93
3.1 Analysis method.....	93
3.2 Study assumptions	94
4	
..... Analysis results – short-term options.....	96
4.1 Option 1: TTU of the Edgecumbe–Kawerau 3 220 kV circuit to 90°C.....	96
4.2 Option 2: TTU of the Wairakei–Whakamaru C line to 100°C.....	98
4.3 Option 3: TTU of the Wairakei–Whakamaru A line	99
4.4 Option 4: Atiamuri 220kV bus split	100
4.5 Preferred short-term upgrades and remaining limitations	101
5	
..... Analysis results - long-term options.....	103
5.1 Option 5: Reconductoring of the WRK–WKM A line	103
5.2 Option 6: Replacement of the WRK–WKM A line by a double circuit line.....	104
5.3 Option 7: Additional WRK–WKM double circuit line following direct route	107
5.4 Option 8: mixed replacement / reconductoring of the WRK–WKM A line.....	108
6	
..... Comparison of the options during planned outages	111
7	
..... Conclusion	
n	113
Appendix A	Contingency-monitor pairs and circuits considered in transfer capacity calculation.....
	115
Appendix B	Generation dispatch
	117
Appendix C	Line parameters
	121

Executive Summary

This report presents the assessment of different Wairakei Ring short-term and long-term grid upgrade options that can be implemented to increase thermal transfer between Wairakei and Whakamaru.

The short-term options have been assessed with the goal in mind to identify any “quick wins” that exist beyond the installation of a series reactor on the Atiamuri–Ohakuri circuit by early 2023, to which Transpower already committed before this analysis was undertaken. It is expected they can be implemented in 0-5 years whereas the long-term options will take approximately 5 - 20 years to implement⁵.

The short-term options are shown in Table 3 and include tactical thermal upgrades (TTUs) and grid reconfigurations. The long-term options are shown in Table 4 and include reconductoring and construction of new lines.

Table 16: Short-term upgrade options

No.	Description
01	Tactical thermal upgrade of the Edgumbe–Kawerau 220 kV circuit
02	Tactical thermal upgrade to 100°C of the Wairakei–Whakamaru C line
03	Tactical thermal upgrade of the Wairakei–Whakamaru A line
04	Atiamuri 220kV bus split

Table 17: Long-term upgrade options

No.	Description
05	Reconductoring of the Wairakei–Whakamaru A line. Different conductor options have been investigated.
06	Replacement of the Wairakei Whakamaru A line by a double circuit line (strung with duplex Sulfur AAAC at 100°C sag). Two different topologies at the Ohakuri substation have been considered.
07	New WRK–WKM double circuit line (strung with duplex Sulfur AAAC at 100°C sag) following the most direct possible route. In this option, the Wairakei–Whakamaru A line is kept unchanged, and the Atiamuri series reactor is set on its highest impedance.
08	Mixed replacement / reconductoring of the WRK–WKM A line: <ul style="list-style-type: none"> ○ Replacement of the Wairakei Whakamaru A line with a double circuit line (strung with duplex Sulfur AAAC at 100°C sag) between Wairakei and Atiamuri ○ reconductoring of the Atiamuri–Whakamaru 1 circuit with Duplex Pheasant at 120°C sag.

Analysis Method

To calculate the transfer capacity for the different reinforcement options the DigSILENT PowerFactory case prepared for the 2021 transmission planning report was used.

The power flow from Wairakei to Whakamaru was controlled by adjusting the active power output of a fictitious static generator connected at the Wairakei 220 kV substation, while the slack bus was set at Whakamaru 220 kV. The Wairakei fictitious generator's active power was increased until the first monitored circuits reached 100% post contingent loading. The transfer capacity was

⁵ Detailed project works scheduling has not been completed at this point in time and these timeframes are indicative only.

calculated for the most severe contingencies in the area. Only thermal transfer limits were calculated in this report. Dynamic stability is not an issue in the Wairakei Ring, because of the small length of the lines forming the ring and the abundance of generation in the area.

The limiting contingency–monitor pair is the first contingency causing one of the monitored circuits to reach 100% post contingent loading, and that specific monitored circuit. Once the most critical contingency–monitor pair was identified, the simulation was stopped, and the Wairakei Ring transfer capacity was then calculated. This transfer capacity is defined as the sum of the active power coming into Whakamaru on the existing three 220 kV circuits of the Wairakei Ring (Whakamaru–Wairakei 1, Te Mihi–Whakamaru 1 and Atiamuri–Whakamaru 1) and on any new circuit into Whakamaru that was added by the relevant Wairakei Ring upgrade option.

Because the Bay of Plenty regional grid is connected to the grid backbone at Atiamuri and Ohakuri on the Wairakei–Whakamaru A line and offers a parallel 220kV path between those two substations (via Kawerau, Edgecumbe and Tarukenga), the load and generation balance in the Bay of Plenty has some influence on the Wairakei Ring transfer capacity. Therefore, the maximum Wairakei Ring transfer capacity was calculated for a wide range of Bay of Plenty load–generation balance.

Short-term Option Analysis Results

Although there are not many remaining short-term upgrade options, this analysis identified that tactical thermal upgrades of the WRK–WKM C line and of the Edgecumbe–Kawerau 3 circuit deliver together a noticeable Wairakei Ring transfer capacity increase when the Bay of Plenty imports power from the grid backbone, which currently happens about 80% to 90% of the time. These TTUs are relatively low cost, and when averaged across the whole Bay of Plenty operating conditions considered in this analysis, they deliver about 293 MW of additional Wairakei Ring maximum transfer capacity on top of what the installation of the Atiamuri series reactor offered.

However, they do not deliver any Wairakei Ring transfer capacity increase when the Bay of Plenty is exporting power to the grid backbone. If this becomes the dominant scenario, a split of the Atiamuri 220 kV bus could be considered as a way to increase the Wairakei Ring maximum transfer capacity under these conditions, but this will happen at the expense of a reduced transfer capability during Bay of Plenty net import and increased grid losses. At this stage, it is not proposed to implement this bus split. If such a large shift of import/export behaviour occurs in the Bay of Plenty, a more significant grid upgrade of the WRK–WKM A line will most likely be required. In this case, the Atiamuri 220 kV bus split could act a temporary option to increase capacity until that more consequent grid upgrade is commissioned.

These short-term upgrades also do not address the low Wairakei Ring transfer capacity issue during planned circuit outages on the WRK–WKM C line. In this situation, generation constraints will be extremely likely in the future even with careful outage coordination between transmission and generation assets in the area.

Long-term Option Analysis Results

The transfer capacity increase for various options is shown in Table 18. For all these long-term options, it is assumed that the proposed short-term options have been implemented.

- Option 5 (reconductoring the WRK–WKM A line) is potentially the lowest-cost long-term option and delivers on average slightly more than 1000 MW of transfer capacity increase. The main drawbacks of this option are the extensive planned outages required for its implementation (10 months in total), the comparatively higher grid losses and lower transfer capacity during planned outages. This option also does not improve the Bay of Plenty security of supply, unlike Options 6 and 8.

- Option 6 (replacing the WRK–WKM A line is replaced by a new double circuit line strung with duplex Sulfur AAAC at 100°C sag) delivers the overall highest transfer capacity). Another key benefit of this option (compared with Options 5 and 7) is that replacing the WRK–WKM A line by a double circuit line would transform Atiamuri and Ohakuri into more robust interface points between the grid backbone and the Bay of Plenty regional grid, enabling further upgrades of this grid when required later in the future.
- Option 7 (additional double circuit line between Wairakei and Whakamaru) also delivers a significant capacity increase, but this increase is less consistent across the range of Bay of Plenty net load due to capacity limitations on the WRK–WKM A line, that remains unchanged in this option. Option 7 does not perform as well as Option 6 in terms of transfer capacity, especially during periods of high Bay of Plenty import or export, and during planned outages on a C line circuit. It also does not improve the Bay of Plenty security of supply, contrarily to Option 6 and 8.
- Option 8 (mixed reconductoring and replacement of the WRK–WKM A line) was created with the intent of delivering most of the benefits of Option 6 at a lower cost. The analysis indicates that the transfer capacity offered by this option is significantly lower (about 500 MW) than Option 6. Transfer capacity during planned circuit outages is also low, comparable to what Option 5 would offer.

Table 18: Transfer capacity increase for different options (MW)

Option No.	Bay of Plenty net load (MW)						Average
	-200	-100	0	100	200	300	
Option 5	1189	948	735	827	1216	1646	1037
Option 6	1975	1734	1523	1614	2002	2433	1824
Option 7	1184	1540	1918	2013	2015	2029	1818
Option 8	1345	1151	985	1127	1550	1999	1306
0-5 Year Preferred Short Term Option	0	0	25	348	665	857	293
Base case	0	0	0	0	0	0	0

9 Purpose of this document

The purpose of this report is to present the analysis results of a range of different short-term and long-term options which have been proposed to increase thermal transfer from Wairakei to Whakamaru via the part of the grid backbone known as the “Wairakei Ring”. Power flow and contingency analysis in DigSILENT PowerFactory has been utilized to perform the analysis and make comparisons.

It is expected the short-term options could be completed in 0 - 5 years and the long-term options could be implemented in the next 5 - 20 years.

10 Background

Overview

The North Island grid backbone comprises the following 220 kV circuits:

- four from Wellington to Bunnythorpe
- three from Bunnythorpe to Wairakei and Whakamaru
- three connecting Wairakei and Whakamaru
- two from Bunnythorpe to Brunswick, then three from Brunswick to Stratford
- two from Stratford to Huntly
- eight into Auckland from Huntly, Ohinewai and Whakamaru.

The inter-island HVDC link and allows power exchange between the North Island (at Haywards) and the South Island (at Benmore). The net annual power flow on the HVDC is northwards, especially at times of North Island peak demand. However, during light load periods, power may flow southward to conserve South Island hydro storage, especially during periods of low hydro inflows in the South Island. The maximum HVDC import at Haywards is 1140 MW.

The existing North Island grid backbone is set out geographically in Figure 1 and schematically in Figure 2.

To help describe transmission system problems and opportunities on the grid backbone, we split the North Island transmission system into five main backbone transmission corridors or areas:

- **Wellington transmission corridor**, which encompasses everything south of Bunnythorpe.
- **Central North Island transmission corridor**, which connects the lower North Island area with Whakamaru and Wairakei.
- **Wairakei Ring transmission corridor**, which encompasses the 220 kV circuits between Wairakei and Whakamaru connecting the major hydro and geothermal generation in the Central North Island, Bay of Plenty and Hawke’s Bay regions to the transmission network.
- **Taranaki transmission corridor**, which encompasses the grid backbone that connects generation in the Taranaki region to the Waikato and Upper North Island (WUNI) and Central North Island areas.
- **WUNI transmission corridor**, which encompasses everything north of Whakamaru, including the Auckland and Northland regions and most of the Waikato region.

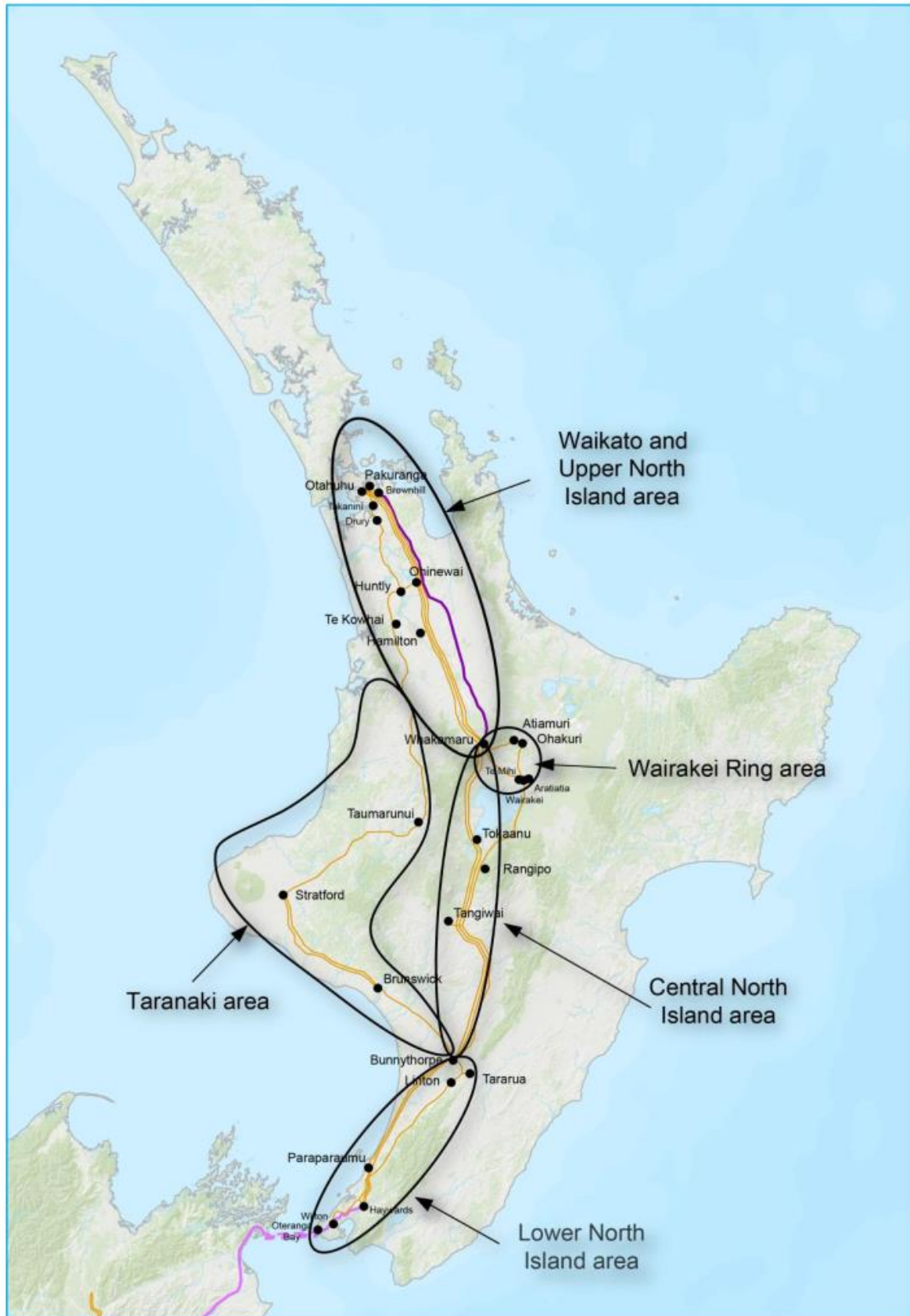

Figure 1: North Island transmission network with the five backbone transmission corridors

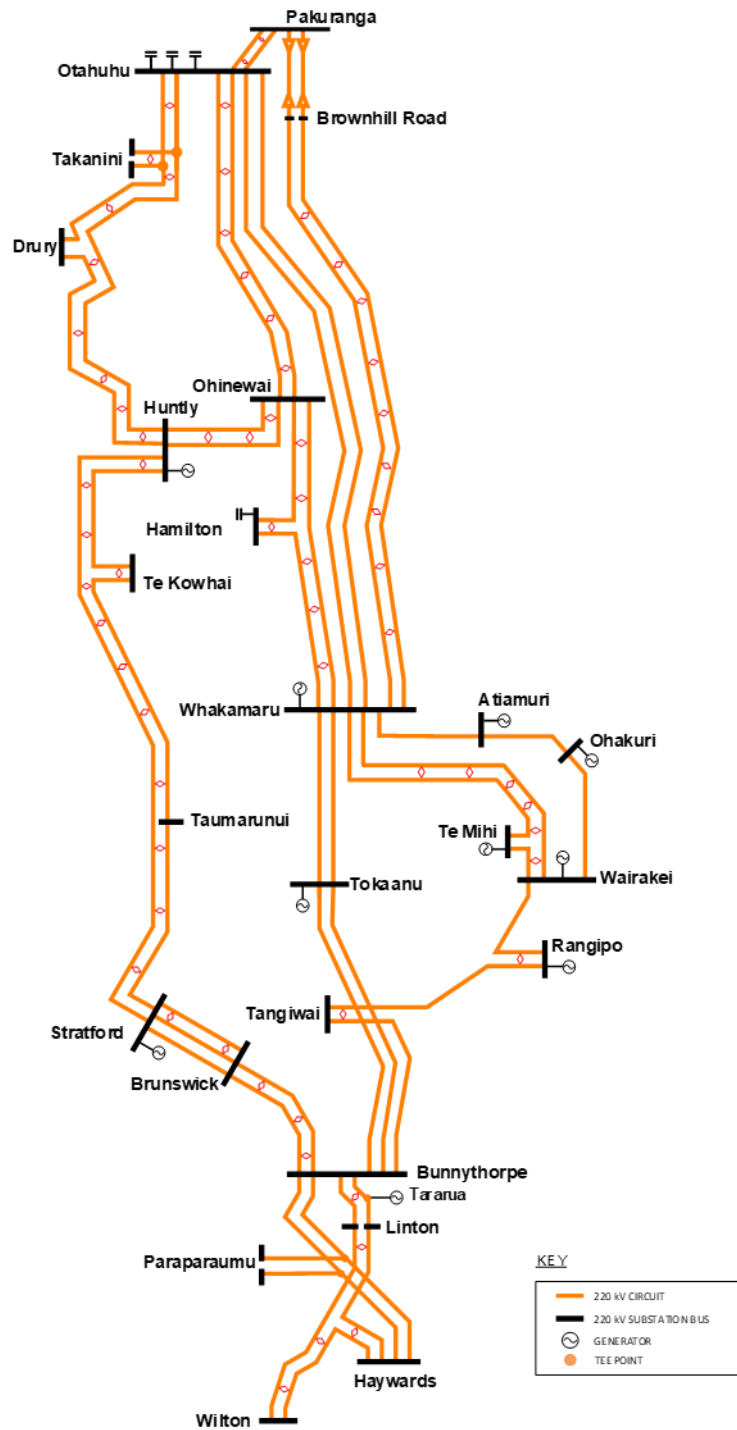

Figure 2: Simplified North Island grid backbone schematic

This investigation focusses on the Wairakei Ring transmission corridor. It connects Wairakei to Whakamaru via two 220kV transmission lines: the Wairakei–Whakamaru A line (WRK–WKM A) and the Wairakei–Whakamaru C line (WRK–WKM C). The C line is a double circuit, high-capacity line that follows a rather direct route (about 40 km) and connects on its way the Te Mihi and Poihipi geothermal stations, that together deliver an almost constant 200 – 220 MW of generation.

The A line is a 220 kV single circuit line with a much smaller capacity, that follows a longer route (about 55.6 km in total) to connect the hydro generation at Ohakuri and Atiamuri. From Atiamuri and Ohakuri, three 220 kV circuits connect the Bay of Plenty region to the grid backbone. Variable

line rating (VLR) is already applied on the circuits forming the WRK–WKM A line to get the maximum capacity out of those limiting circuits.

What happens in the Bay of Plenty grid has a significant impact on the flows on the WRK–WKM A line. Therefore, it is important to describe here some meaningful aspects of this regional grid.

Figure 3 displays a simplified transmission schematic of the Wairakei Ring and the Bay of Plenty regional network, while

The regional grid in the Bay of Plenty offers a parallel 220 kV path between Ohakuri and Atiamuri, via Kawerau, Edgecumbe and Tarukenga. 220/110 kV interconnection transformers are located at Tarukenga, Kaitimako, Kawerau and Edgecumbe. All the generation in the region and most of the loads are connected on the 110 kV regional grid. Despite hosting some generation (hydro at Arapuni, Tauranga and Rotorua – cogeneration at Kinleith), the western 110 kV grid is dominated by load most of the time. The eastern 110 kV grid is strongly dominated by generation, with almost 300 MW of hydro and geothermal generation connected at Kawerau 110 kV. The generation excess has three paths to flow out of Kawerau: on one side the 220 kV circuit Kawerau–Ohakuri towards the Wairakei Ring, on the other side, the 220 kV circuit Edgecumbe–Kawerau–3, and the low capacity 110 kV grid Kawerau – Edgecumbe–Owhata–Tarukenga towards the load centre in Western Bay of Plenty.

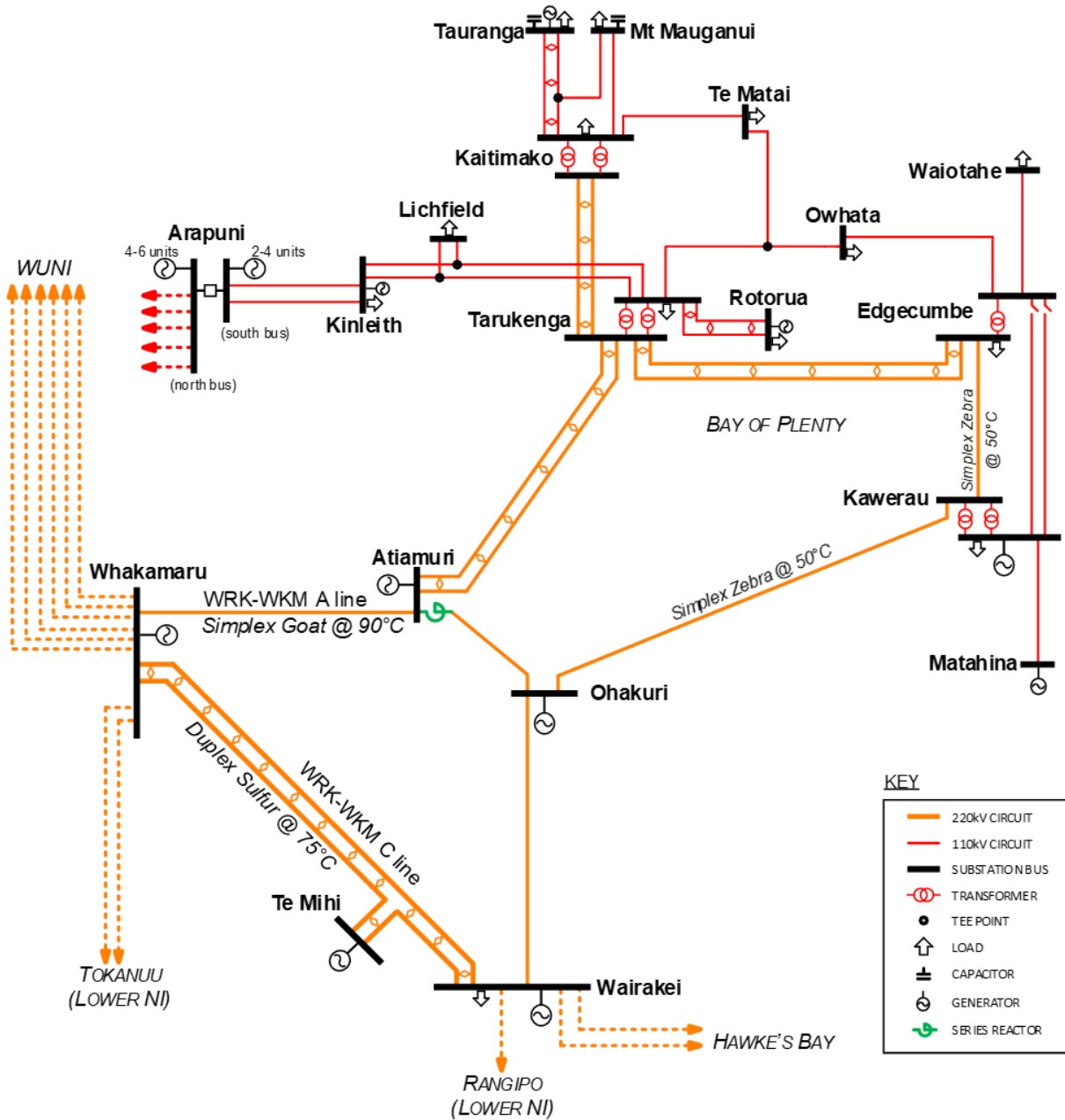

Figure 3: transmission schematic of the Wairakei Ring and the Bay of Plenty regional grid (with Atiamuri series reactor and the Edgcumbe – Kawerau 110kV system split implemented)

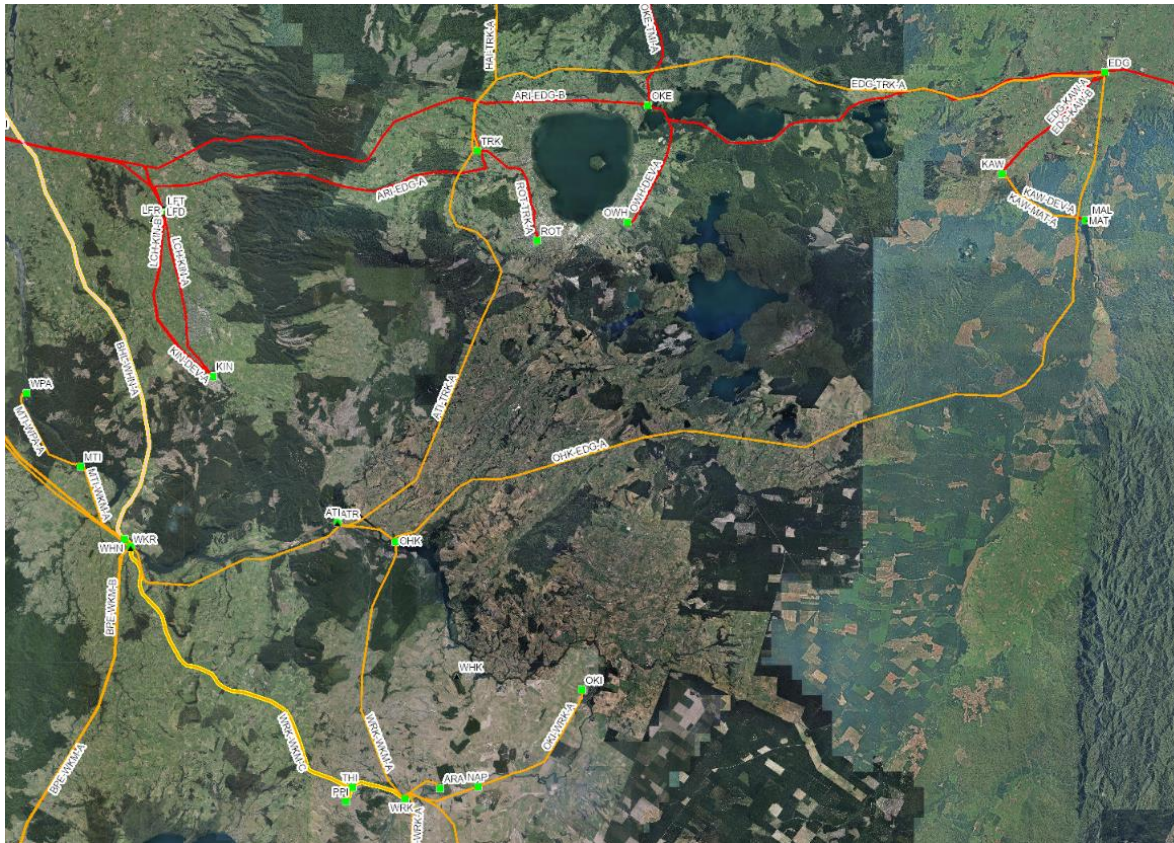

Figure 4: geographic overview of the Wairakei Ring and the Bay of Plenty regional grid

Current Issues

With several new generation projects confirmed in the region (Contact’s Tauhara and Te Huka Unit 3 geothermal power plants, Meridian’s Harapaki wind farm and Nova’s solar farm) and several others being currently considered (solar farms in the Eastern Bay of Plenty and Hawke’s Bay, more geothermal power stations at Kawerau and in the Taupō region), there are requirements to increase north flow transmission through the Wairakei Ring.

Transpower is currently installing a series reactor on the Atiamuri–Ohakuri circuit to better balance the power flows between the WRK–WKM–A and WRK–WKM–C lines. This reactor is a low cost and easy to implement solution that will deliver between 375 and 570 MW of additional Wairakei Ring transmission capacity depending on the Bay of Plenty load and generation balance. Figure 5 illustrates how the addition of this series reactor increases the maximum Wairakei Ring transfer across a range of Bay of Plenty net load, compared with the existing grid. It also shows the contingency–monitor pairs that constrain the transfer capacity for a specific Bay of Plenty net load.

This transmission capacity increase will most likely not be enough to prevent the ring from causing generation constraints in the medium to long-term, as more generation gets connected in the area and load increases in the Western Bay of Plenty. Therefore, further grid upgrades need to be investigated.

Furthermore, maintenance outages on circuits that are part of the high-capacity WRK–WKM C line (Te Mihi–Whakamaru 1, Te Mihi–Wairakei 1 and Whakamaru–Wairakei 1) are already hard to schedule with the existing generation due to the large reduction of Wairakei Ring transfer capacity that they cause. During these outages, the n-1 transfer capacity is capped by the transmission capacity of the WRK–WKM A line, between 340 MVA and 475 MVA depending on the month and time of the day.

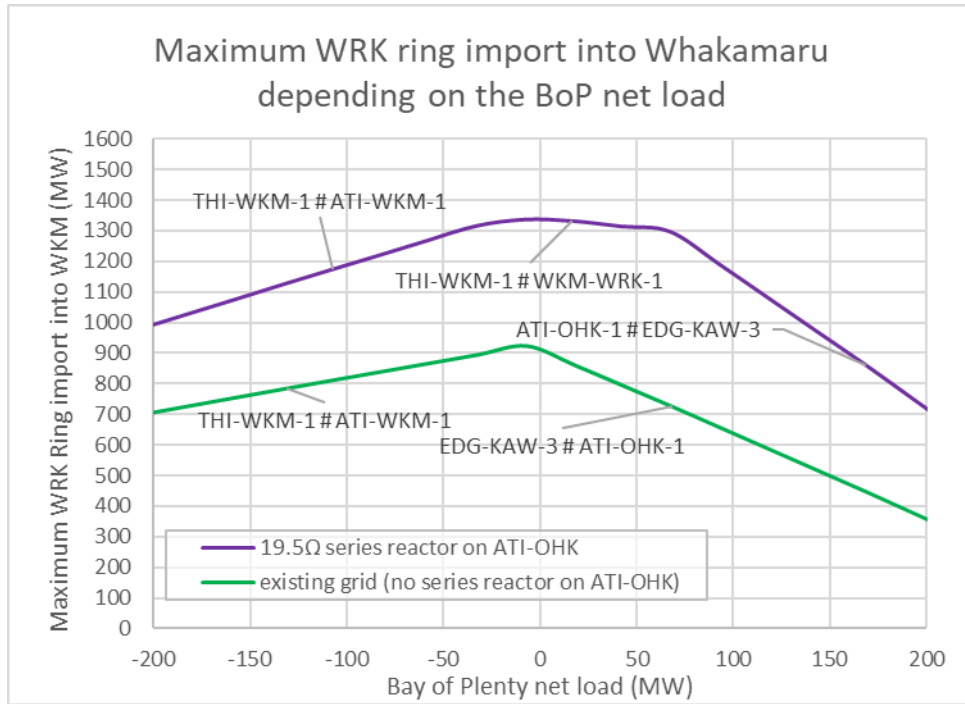

Figure 5: maximum Wairakei Ring transfer capacity – existing grid and addition of ATI-OHK series reactor

11 Methodology and assumptions

This section explains the method and assumptions used to complete the Wairakei Ring grid upgrade analysis explained in this report.

11.1 Analysis method

Python scripts were developed to calculate the Wairakei Ring maximum thermal transmission capacity in DigSILENT PowerFactory under several conditions, and to identify the limiting contingency–monitor pair in each condition.

To identify thermal transfer capacity across the Wairakei Ring, the power flow from Wairakei to Whakamaru was adjusted until the first monitored circuits reached 100% post contingent loading for any of the considered contingencies. The power flow from Wairakei to Whakamaru was controlled by changing the active power output of a fictitious static generator connected at the Wairakei 220 kV substation, while the slack bus was set at Whakamaru 220 kV.

The transfer capacity was calculated for a selection of contingency–monitor pairs shown in Table 6⁶. These contingencies were regarded as the worst in the area. Only thermal transfer capacity were calculated in this report; dynamic stability is not an issue in the Wairakei Ring, because of the small length of the lines forming the ring and the abundance of generation in the area.

⁶ The list of contingency-monitor pairs was changed appropriately for the upgrade options where new circuits are added, or existing circuits are reconfigured. See Appendix F for more details.

Table 19: Contingency–monitor pairs (for the existing grid)

Contingency	Monitor
ATI-OHK-1	EDG-KAW-3
ATI-OHK-1	THI-WKM-1
ATI-OHK-1	WKM-WRK-1
ATI-WKM-1	THI-WKM-1
ATI-WKM-1	WKM-WRK-1
EDG-KAW-3	ATI-OHK-1
EDG-KAW-3	ATI-TRK-1
EDG-KAW-3	ATI-TRK-1
EDG-KAW-3	THI-WKM-1
EDG-KAW-3	WKM-WRK-1
OHK-WRK-1	THI-WKM-1
OHK-WRK-1	WKM-WRK-1
THI-WKM-1	ATI-OHK-1
THI-WKM-1	ATI-WKM-1
THI-WKM-1	EDG-KAW-3
THI-WKM-1	WKM-WRK-1
WKM-WRK-1	ATI-OHK-1
WKM-WRK-1	ATI-WKM-1
WKM-WRK-1	EDG-KAW-3
WKM-WRK-1	THI-WKM-1

The limiting contingency–monitor pair is the contingency causing one of the monitored circuits to reach 100% post contingent loading, and that specific monitored circuit. Once the most critical contingency–monitor pair was identified, the simulation was stopped, and the Wairakei Ring transfer capacity was then calculated. This transfer capacity is defined as the sum of the active power coming into Whakamaru on the existing three 220 kV circuits of the Wairakei Ring (Whakamaru–Wairakei 1, Te Mihi–Whakamaru 1 and Atiamuri–Whakamaru 1) and on any new circuit into Whakamaru that was added by the relevant Wairakei Ring upgrade option.

Because the Bay of Plenty regional grid is connected to the grid backbone at Atiamuri and Ohakuri on the Wairakei–Whakamaru A line and offers a parallel 220 kV path between those two substations (via Kawerau, Edgecumbe and Tarukenga), the load and generation balance in the Bay of Plenty has some influence on the Wairakei Ring transfer capacity. Therefore, the maximum Wairakei Ring transfer capacity was calculated for a wide range of Bay of Plenty load–generation balance.

11.2 Study assumptions

The studies have used the DlgSILENT PowerFactory case prepared for the 2021 transmission planning report.

11.2.1 Asset ratings

The technical analysis was conducted only on the winter study cases. For this work 15-minute offload times were not used.

- For transmission circuits, the branch rating was used.
- For transformers, the continuous branch limit was used pre-contingency while the post contingency 24-hour branch limit was used post-contingency.

11.2.2 Tactical Thermal Upgrades and Variable Line Ratings

Some of the analysed scenarios have tactical thermal upgrades (TTUs) applied to circuits in the Wairakei Ring. The upgraded circuit capacities after a TTU were calculated using the Latta formula for the relevant design sag temperature, using the standard parameters⁷.

11.2.3 Demand forecast

The island peak winter 2025 prudent forecast (TPR 2021, V1) was used for this study.

11.2.4 Generation

The analysis assumed that the Huntly Rankine units are decommissioned.

The Taranaki Combined Cycle (TCC) unit is still in service in the model used, but it does not affect significantly the Wairakei Ring power transfer.

A fictitious generator was connected at the Wairakei 220 kV busbar, while the slack bus was set at the Whakamaru 220 kV busbar. This was used to increase northwards power flow from Wairakei to Whakamaru to find thermal transfer limits. In general, throughout the studies this slack absorbed power. The fictitious generator was set to hold the Wairakei 220 kV busbar at 1.02 p.u.

Appendix G gives a list of generation dispatch settings used as starting point for this analysis. Hydro generation was dispatched at 95% of installed capacity, geothermal generation at 98% of installed capacity, and existing wind generation at 20% of installed capacity.

11.2.5 Adjustment of Bay of Plenty generation–load balance

The maximum Wairakei Ring transfer capacity was calculated for a wide range of Bay of Plenty load–generation balance. Historic data from past years show that the Bay of Plenty net load currently varies between about 300 MW and -100 MW, being most of the time between 100 MW and -25 MW (see Figure 6).

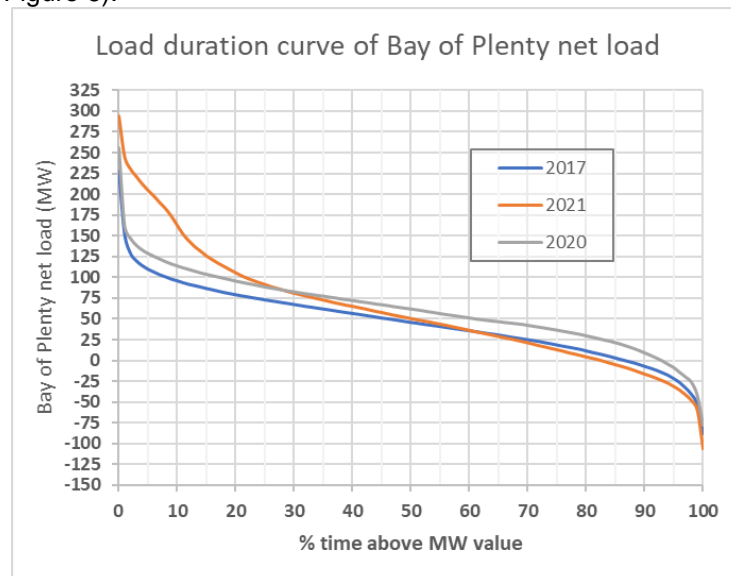

Figure 6: load duration curve of the Bay of Plenty net load

It is difficult to predict how the Bay of Plenty net load will evolve in the future, as there are prospects of generation development in the East (Edgecumbe, Kawerau, Waiotahi) and of large load increase in the West (Tauranga, Kaitimako, Te Matai...). Any of these prospects would also result in higher East to West power flows within the regional 220 kV and 110 kV grid, which compounded by higher Wairakei Ring north flow can create or exacerbate transmission constraints in this grid.

⁷ Conductor emissivity = 0.5; perpendicular wind with a speed of 0.61 m/s

In this work, the Bay of Plenty load–generation balance was adjusted between -200 MW and 300 MW by modifying the power output of a fictitious generator connected in the Bay of Plenty. Two different connection points were assessed: Kaitimako 110 kV (to reflect a Western Bay of Plenty load increase) and Edgecumbe 220 kV (to reflect generation development in the Eastern Bay of Plenty). The resulting Wairakei Ring transfer capacity for both locations and a specific Bay of Plenty load–generation balance were then averaged.

11.2.6 Possible projects

The following projects relevant to this analysis were assumed completed and in service for the study scenarios:

- Tauhara Generation Station
- Harapaki Wind Farm
- Atiamuri–Ohakuri Series Reactor – the impedance of this reactor can be adjusted offload on site at the following values: 12, 14.5, 17 and 19.5 Ohms. The 19.5 Ohms reactance was used in this study, as it offers the best transfer capacity on average.
- Edgecumbe–Kawerau 110 kV system split

Both our latest Transmission Planning Report and this analysis suggest that the Edgecumbe–Kawerau 110 kV system split will be required in the next five years to prevent pre-contingency overloads of the low capacity Edgecumbe–Owhata 110 kV circuit. This circuit already sees high power flows from Edgecumbe to Owhata most of the time and as explained in section 11.2.5 the expected load and generation developments in the Bay of Plenty will greatly increase these flows. The system split is required to avoid pre-contingency generation constraints in the Eastern Bay of Plenty, and to create additional generation capacity at Waitotahi. It will also reduce the grid losses, which was confirmed by our SDDP generation dispatch analysis.

12 Analysis results – short-term options

This section describes the short-term options and summarises the results of the analysis for each of them. Table 7 shows the options considered. It is important to note that these options are not mutually exclusive; in fact, in some cases implementing several of these options has a compounding effect in increasing the Wairakei Ring transmission capacity.

Table 20: Short-term upgrade options

No.	Type	Description
01	Thermal Upgrade	Tactical thermal upgrade of the Edgecumbe–Kawerau 220 kV circuit to 90°C
02	Thermal Upgrade	Tactical thermal upgrade of the Wairakei–Whakamaru C line to 100°C
03	Thermal Upgrade	Tactical thermal upgrade of the Wairakei–Whakamaru A line
04	Grid reconfiguration	Atiamuri 220 kV bus split

After assessing the different options, checks were completed to assess any voltage violations present in the cases with the highest thermal transfer capacity.

12.1 Option 1: TTU of the Edgecumbe–Kawerau 3 220 kV circuit to 90°C

Following the commissioning of the Atiamuri–Ohakuri series reactor, the Edgecumbe–Kawerau 3 220 kV circuit may limit the power transfer from Wairakei to Whakamaru during periods of high Kawerau generation excess and medium to high Bay of Plenty net load.

Figure 7 illustrates the maximum Wairakei Ring transfer capacity across the range of Bay of Plenty net load for several levels of Kawerau generation excess (150 MW, 180 MW, 210 MW and 240 MW), with or without a TTU of the Edgecumbe–Kawerau 3 circuit. As background information, Figure 8 shows the duration curve of the generation excess at Kawerau.

The following observations can be made:

- When the Bay of Plenty net load is low or negative, the Wairakei Ring transfer capacity is limited for the Atiamuri–Whakamaru 1 circuit capacity, after a Te Mihi–Whakamaru 1 circuit outage.
- The higher the level of Kawerau generation excess, the more the Wairakei ring transfer capacity is limited by the Edgcumbe–Kawerau 3 circuit as the net Bay of Plenty load increases. This constraint also appears for lower levels of Bay of Plenty net load when the Kawerau generation excess increase. This can be explained by the fact that as the Kawerau generation excess increases, more fictitious load needs to be added at Edgcumbe 220 kV or Kaitimako 110 kV to keep the same level of Bay of Plenty net load, which increases the East to West power flow in the regional grid and increases the loading on Edgcumbe–Kawerau 3.
- Without a TTU of the Edgcumbe–Kawerau 3 circuit, it is not possible to achieve concurrently large power transfer from Wairakei to Whakamaru and a high generation excess at Kawerau. If generation needs to be constrained, Figure 7 shows that it is more efficient to constrain generation at Kawerau than at Wairakei to prevent post-contingency overloads on Edgcumbe–Kawerau 3 and maximise the Wairakei Ring transfer capacity. When the Kawerau generation excess is lower than about 180 MW, the Wairakei Ring transfer capacity is not affected by the Edgcumbe–Kawerau 3 circuit capacity when the net Bay of Plenty load is positive; instead, it is capped by the Whakamaru–Wairakei 1 circuit (after a Te Mihi–Whakamaru 1 circuit outage).

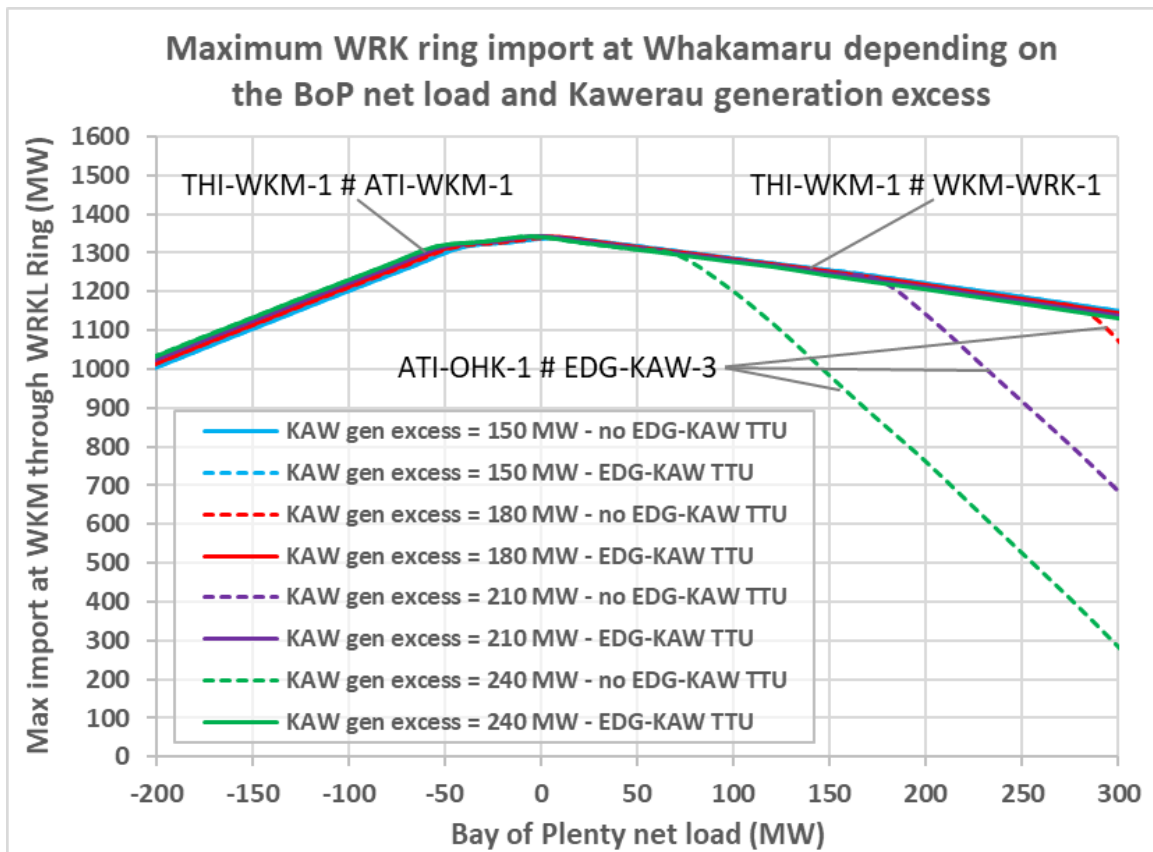

Figure 7: Wairakei Ring maximum transfer capacity with and without Edgcumbe–Kawerau 3 TTU for different levels of Kawerau generation excess and Bay of Plenty net load (without WRK–WKM C line TTU)

Implementing a TTU to 90°C on the Edgcumbe–Kawerau 3 circuit will prevent this circuit from constraining the Wairakei Ring power transfer, moving the constraint to the Whakamaru–Wairakei 1 circuit (after a Te Mihi–Whakamaru 1 circuit outage). Besides its benefits in terms of increasing the grid backbone transmission capacity, this TTU is also beneficial to the regional grid, as it will

facilitate the connection of additional generation at Kawerau and increase the transmission capacity between the Eastern and the Western Bay of Plenty.

The Edgcumbe–Kawerau 3 220 kV circuit is strung with simplex ZebraGZ conductor at 50°C design sag temperature, offering a transmission capacity of 291 / 266 / 239 MVA (winter / shoulder / summer). Thermally upgrading this circuit to 90°C would lift the circuit ratings to 424 / 409 / 394 MVA (winter / shoulder / summer). As the circuit is relatively short (about 23 km), the cost of the TTU is expected to be quite low.

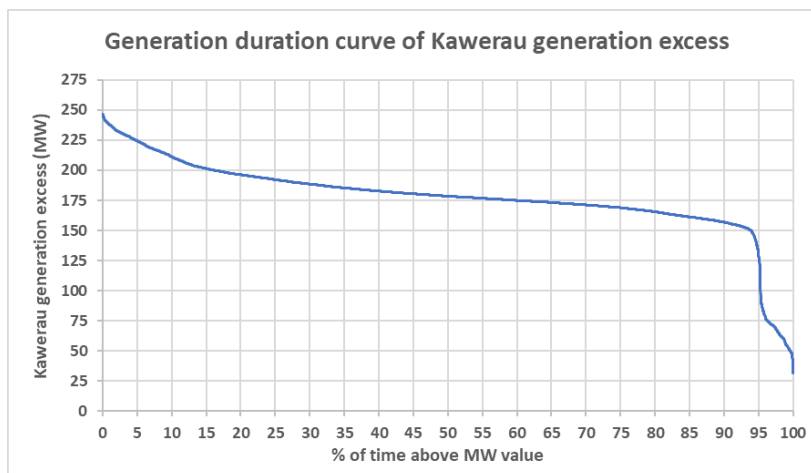

Figure 8: generation duration curve of Kawerau generation excess (2021-2022 data)

12.2 Option 2: TTU of the Wairakei–Whakamaru C line to 100°C

In the short-term, a TTU of the Wairakei–Whakamaru C line would deliver Wairakei Ring transfer capacity increase when the net Bay of Plenty load is positive, if it is implemented in conjunction with the Edgcumbe–Kawerau 3 TTU. On its own, the C line TTU will deliver little capacity increase, because across the range of likely Bay of Plenty net load, the circuits on the C line are rarely the first constraining circuits (see Figure 5 and Figure 14).

The Wairakei–Whakamaru C line is a recent line strung with duplex Sulfur AAAC conductor at 75°C design sag temperature. This conductor can be thermally upgraded to 100°C, which would increase the seasonal ratings of the conductor from 994 / 950 / 903 MVA to 1169 / 1134 / 1098 MVA (winter / shoulder / summer).

More broadly, what we refer as the TTU of the Wairakei–Whakamaru C line also encompasses the required substation equipment upgrades to ensure that the full capacity increase obtained by thermally upgrading the conductors can be used. Currently, for the C line the most important branch constraint occurs on the Whakamaru–Wairakei 1 circuit and is caused by a disconnector and a current transformer rated at 2500 Amperes (953 MVA).

Figure 14 illustrates the compounding effect of the Edgcumbe–Kawerau 3 TTU and the Wairakei–Whakamaru C line TTU to increase the maximum Wairakei Ring transfer capacity when the Bay of Plenty net load is positive. On average across the range of Bay of Plenty operating conditions, these two TTUs combined deliver about 1300 MW of Wairakei Ring maximum transfer capacity,

which represents an increase of about 293 MW compared with the base case where only the Atiamuri series reactor is installed.

Figure 14 also shows that these TTUs do not increase the transfer capacity when the Bay of Plenty region exports power to the grid backbone, because the limiting circuit is the Atiamuri–Whakamaru–1 circuit, after a Te Mihi–Whakamaru 1 outage.

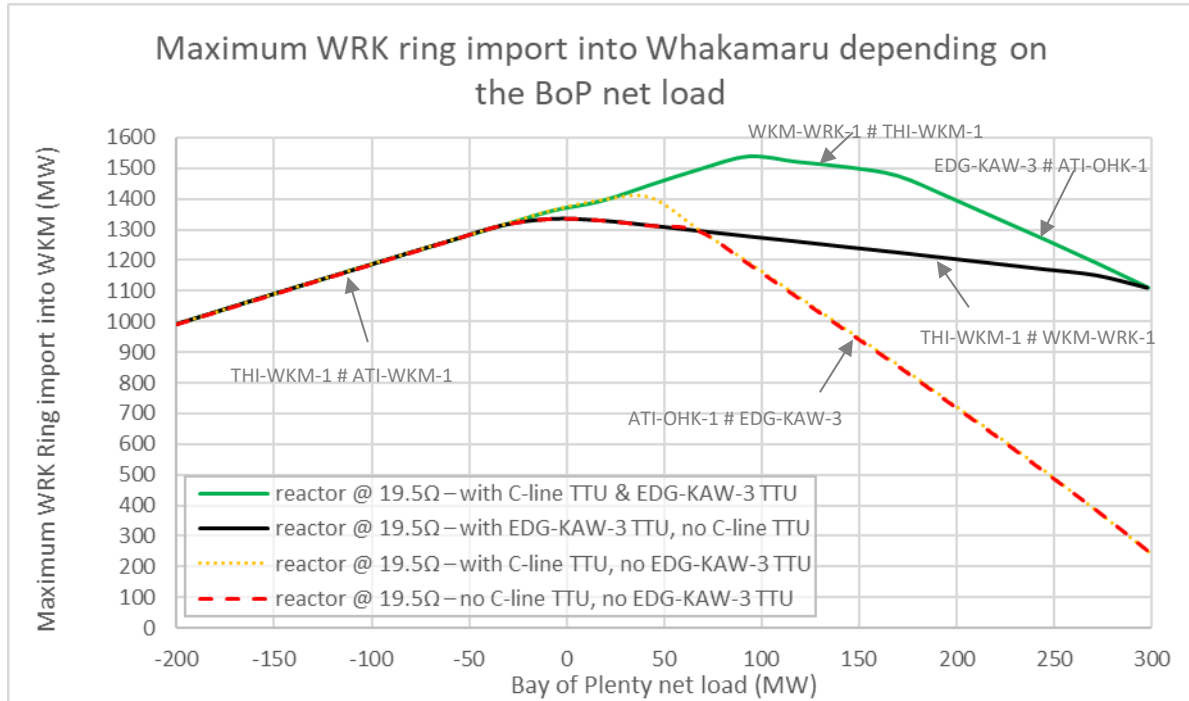

Figure 9: Wairakei Ring maximum transfer capacity with and without WRK–WKM C line TTU

12.3 Option 3: TTU of the Wairakei–Whakamaru A line

As indicated previously, a TTU of the Wairakei–Whakamaru A line would increase the maximum Wairakei Ring transfer capacity when the Bay of Plenty region exports power to the grid backbone. Currently, power export from the Bay of Plenty rarely occurs, and is rather limited in amplitude when it happens (see Figure 6). Considering the many generation connection enquiries received in the Bay of Plenty the last few years, larger and more frequent generation exports from the Bay of Plenty are plausible in the future.

The circuits on the Wairakei–Whakamaru A line are already operated at 90°C maximum designed sag temperature. Unfortunately, laboratory tests on the grease used on these conductors revealed that grease migration issues would occur if the maximum conductor operating temperature were increased above its current value. Therefore, a TTU of the Wairakei–Whakamaru A line was discarded for obvious environmental considerations and not further studied here.

12.4 Option 4: Atiamuri 220kV bus split

A possible short-term option to avoid the Atiamuri–Whakamaru 1 circuit limiting the Wairakei Ring maximum transfer capacity could be to open the bus coupler at the Atiamuri 220 kV substation. As shown on the single line diagram below (Figure 19), this bus split increases the impedance between Whakamaru, Tarukenga and Ohakuri, as both Atiamuri–Tarukenga 220 kV circuits are now connected on two electrically distinct busses at Atiamuri and power wanting to flow from Ohakuri to Whakamaru has to do “a return trip to Tarukenga” with the bus split in place at Atiamuri. This impedance increase will lead to a larger part of the Wairakei Ring power flow being redirected towards the Wairakei–Whakamaru C line, hence reducing the power flow on the Atiamuri–Whakamaru circuit for a given level of Wairakei Ring power transfer.

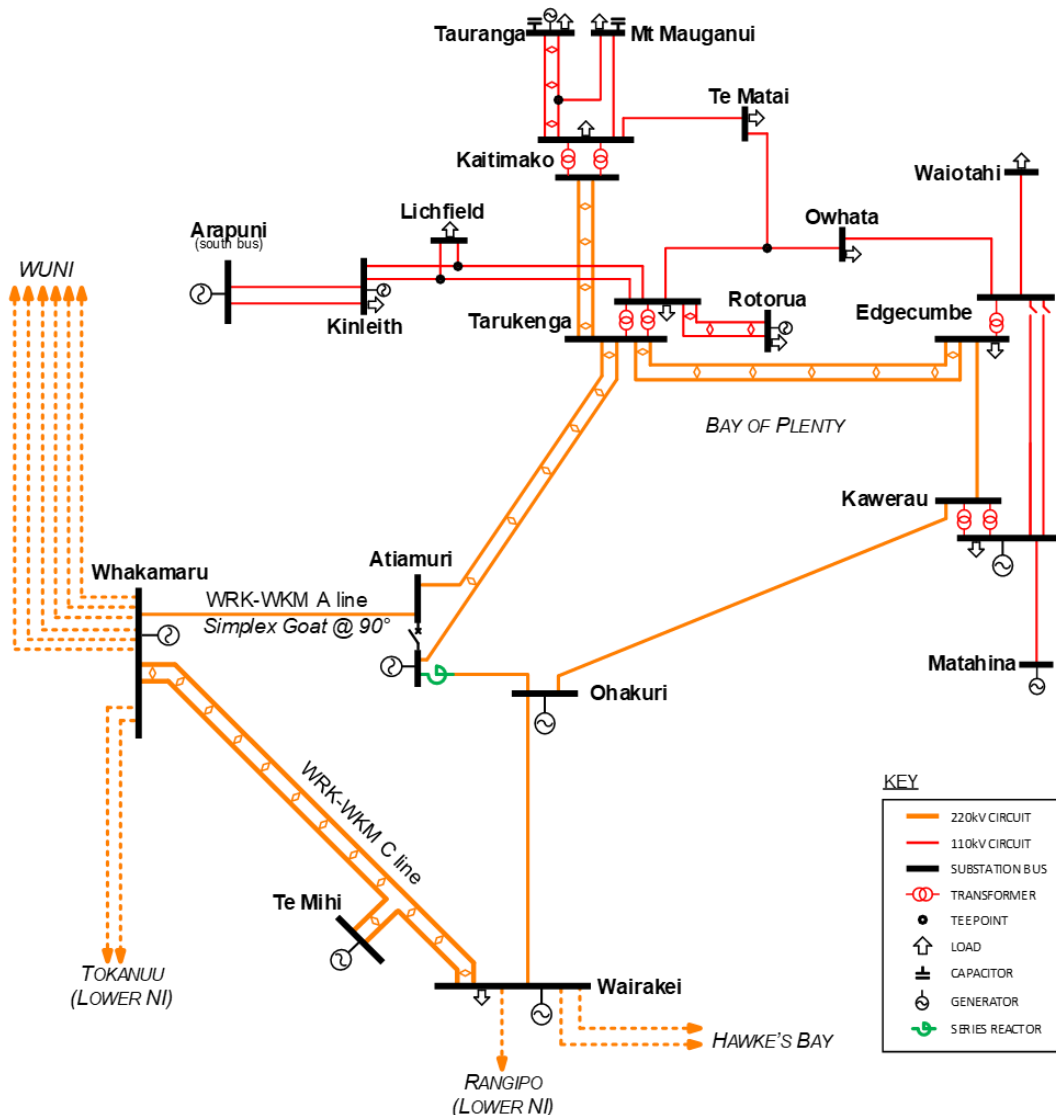

Figure 10: transmission schematic of the Wairakei Ring and the Bay of Plenty grid with Atiamuri 220 kV bus split

Figure 11 compares the maximum Wairakei Ring transfer capacity across the range of Bay of Plenty net load with and without the bus split at Atiamuri 220 kV, assuming that the TTUs on the Edgecumbe–Kawerau 3 circuit and on the WRK–WKM C line have been completed.

The following observations can be made:

- As explained above, splitting the Atiamuri 220 kV bus allows a substantial increase of the maximum Wairakei Ring transfer capacity when the Bay of Plenty exports power to the grid backbone.

- However, when the Bay of Plenty is importing power from the grid backbone, the maximum Wairakei Ring transfer capacity is smaller when the Atiamuri 220 kV bus is split. This is caused by two factors. Firstly, the C line capacity limit binds earlier with the split bus for low level of Bay of Plenty import. Secondly, for higher levels of Bay of Plenty net load, an outage of the Edgcumbe–Kawerau 3 circuit overloads the Atiamuri–Tarukenga 220 kV circuit connected to the South bus when high Wairakei ring transfer is attempted. As the Atiamuri 220 kV bus is split, the power flow from Atiamuri to Tarukenga is unevenly distributed between the two Atiamuri–Tarukenga circuits, with the circuit on the generation-rich side (the “South bus”) taking a larger share of the flow.

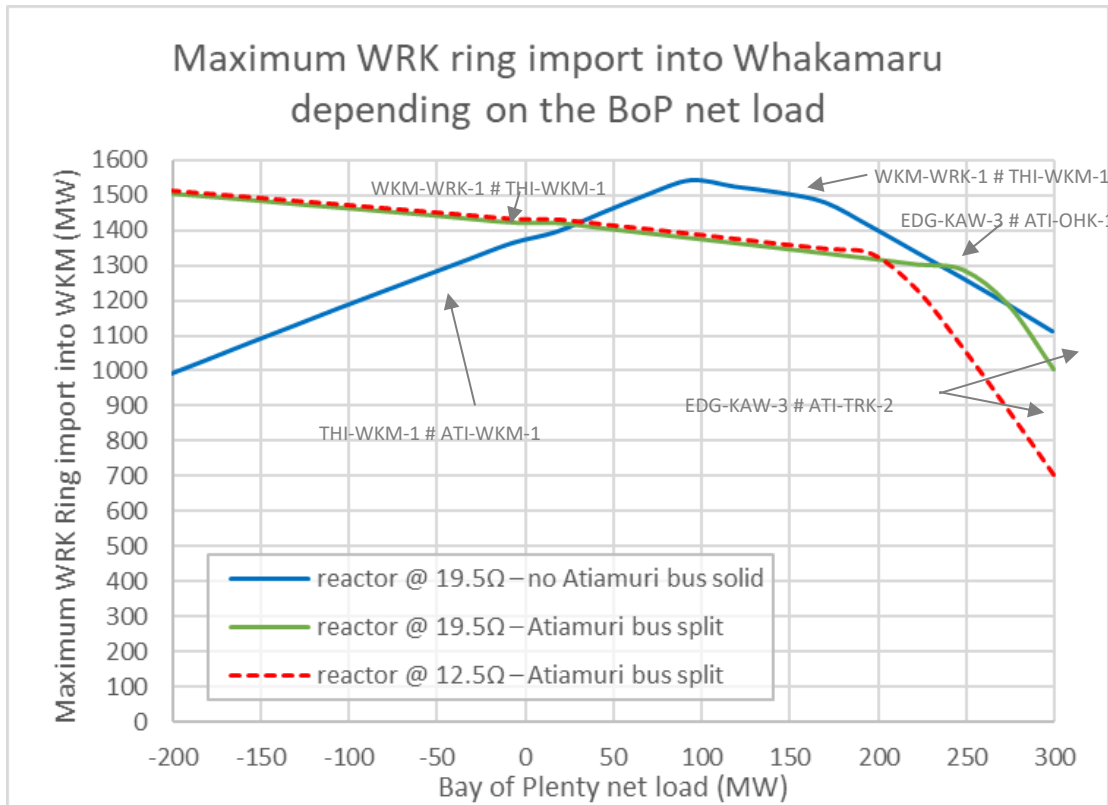

Figure 11: Wairakei Ring maximum transfer capacity with and without Atiamuri 220 kV bus split

Splitting the Atiamuri 220 kV bus might be a valid option in case the Bay of Plenty becomes mostly a next exporter, but it will come with the price of a reduced transfer capability when the import behaviour dominates. For some planned outages, the Atiamuri 220 kV bus coupler will have to be closed. Furthermore, this bus split would cause an increase of the grid losses in most situations.

12.5 Preferred short-term upgrades and remaining limitations

Although there are not many remaining short-term upgrade options, this analysis identified that tactical thermal upgrades of the WRK–WKM C line and of the Edgcumbe–Kawerau 3 circuit together deliver a noticeable Wairakei Ring transfer capacity increase when the Bay of Plenty imports power from the grid backbone, which currently happens about 80% to 90% of the time. These TTUs are relatively low cost, and when averaged across the whole Bay of Plenty operating conditions considered in this analysis, they deliver about 293 MW of additional Wairakei Ring maximum transfer capacity on top of what the installation of the Atiamuri series reactor offered.

However, they do not deliver any Wairakei Ring transfer capacity increase when the Bay of Plenty is exporting power to the grid backbone. If this becomes the dominant scenario, a split of the Atiamuri 220 kV bus could be considered as a way to increase the Wairakei Ring maximum transfer capacity under these conditions, but this will happen at the expense of a reduced transfer

capability during Bay of Plenty net import and increased grid losses. At this stage, it is not proposed to implement this bus split. If such a large shift of import/export behaviour occurs in the Bay of Plenty, a more significant grid upgrade of the WRK–WKM A line will most likely be required. In this case, the Atiamuri 220 kV bus split could act a temporary option to increase capacity until that more consequent grid upgrade is commissioned.

Finally, it is important to stress that while these short-term upgrades are increasing the Wairakei Ring transfer capacity in N situation (all circuits available), they do not address at all the low transfer capacity issue that currently occurs during planned outages on a circuit of the WRK–WKM C line. This limit is set by the transmission capacity of the WRK–WKM A line, and as explained earlier, it is not possible to further uprate the existing conductor on this line. As more generation gets developed in the area, it seems likely that generation constraints will be required during those planned outages, even with careful coordination between circuit outages and generation outages. There is no easy way to avoid these constraints without a significant grid upgrade. In this specific case, a generation runback special protection scheme would be very complex to implement, as many generators in different locations would need to be involved. The efficiency of the runback itself is somewhat uncertain, as the generation reduction triggered by the runback would be partially compensated by the generation increase triggered by the frequency response of all the generators in the area of influence. The only way to avoid this effect would be to match the generation runback by an equivalent generation ramp up (or load curtailment) on the other side of the constraint. In today's context, this seems extremely complex to implement.

13 Analysis results - long-term options

Table 10 shows the long-term options that have been assessed. The details on the electrical parameters for each option can be found in Appendix E.

Unless stated otherwise, in this section the preferred short-term grid upgrades are assumed to have been completed:

- a TTU of the Edgecumbe–Kawerau 3 220kV circuit to 90°C
- a TTU of the WRK–WKM C line to 100°C

For comparison purposes, the transfer capacity graphs in this section contain a fixed trend (pink plain line) showing the Wairakei Ring maximum transfer capacity if only the preferred short-term upgrades are completed.

Table 21: Long-term upgrade options

No.	Description
05	Reconductoring of the WRK–WKM A line. Different conductor options have been investigated.
06	Replacement of the WRK–WKM A line by a double circuit line (strung with duplex Sulfur AAAC at 100°C sag). Two different topologies at the Ohakuri substation have been considered.
07	New WRK–WKM double circuit line (strung with duplex Sulfur AAAC at 100°C sag) following the most direct possible route.
08	Mixed replacement / reconductoring of the WRK–WKM A line: <ul style="list-style-type: none"> ○ Replacement of the Wairakei Whakamaru A line by a double circuit line (strung with duplex Sulfur AAAC at 100°C sag) between Wairakei and Atiamuri ○ reconductoring of the Atiamuri–Whakamaru 1 circuit with Duplex Pheasant at 120°C sag.

13.1 Option 5: Reconductoring of the WRK–WKM A line

The first long-term option consists of reconductoring the circuits on the WRK–WKM A line with higher capacity and lower impedance conductor. Once the reconductoring is completed, the series reactor that was previously installed on Atiamuri–Ohakuri 1 circuit would become redundant (due to the large capacity increase of the WRK–WKM A line) and would be put in storage for a potential use elsewhere on the grid.

Several different conductor options have been considered:

- Simplex Chukar Mod AC at 120°C design sag temperature, which would increase the WRK–WKM A line's seasonal ratings to 801 / 783 / 764 MVA (winter / shoulder / summer).
- Duplex Goat AC at 120°C design sag temperature, which would increase the WRK–WKM A line's seasonal ratings to 864 / 844 / 823 MVA (winter / shoulder / summer).
- Duplex Zebra AC at 120°C design sag temperature which would increase the WRK–WKM A line's seasonal ratings to 1006 / 983 / 959 MVA (winter / shoulder / summer).

Figure 12 displays the maximum Wairakei Ring transfer capacity across the range of Bay of Plenty load–generation balance for the three reconductoring options described above, with or without the TTU of the WRK–WKM C line implemented.

The following observations can be made:

- The TTU of the WRK–WKM C line enables higher Wairakei Ring transfer for all reconductoring options. This is because the reconductoring of the WRK–WKM A line shifts the capacity constraint to the WRK–WKM C line in the absence of this TTU.
- Reconductoring with Duplex Zebra delivers the highest Wairakei Ring maximum transfer, about 2040 MW on average. This is approximately 745 MW more than the average maximum transfer capacity of the option with only the short-term upgrade implemented.

The transfer capacity remains relatively constant across the range of Bay of Plenty net load and is constrained by the WRK–WKM C line circuit capacity.

- Reconductoring with Duplex Goat delivers a lower and more variable maximum transfer capacity. The conductor rating of Duplex Goat is about 140 MW lower than Duplex Zebra, which causes the WRK–WKM A line to limit the Wairakei Ring transfer capacity (the Atiamuri–Whakamaru 1 circuit is constraining when the Bay of Plenty exports power to the grid backbone, while the Atiamuri–Ohakuri 1 circuit is constraining when the Bay of Plenty imports power).
- Reconductoring with Simplex Chukar delivers on average the lowest transfer capacity increase of the three options. As Simplex Chukar leads to a significantly higher impedance than Duplex Goat, the limiting line for the Simplex Chukar reconductoring is the WRK–WKM C line.

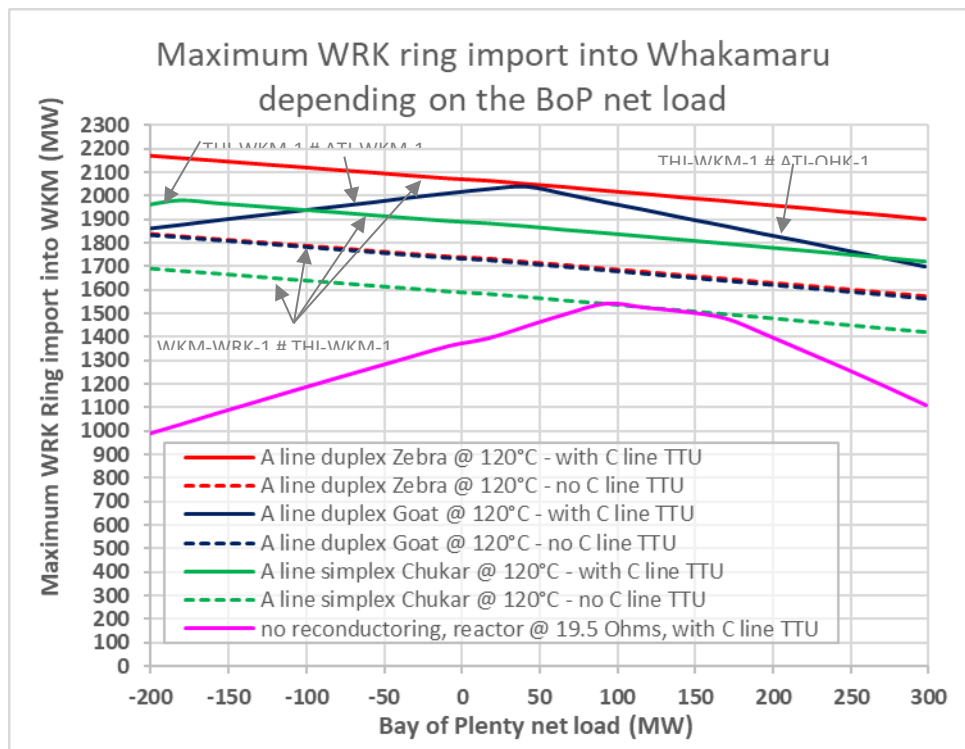

Figure 12: Wairakei Ring maximum transfer capacity – WRK–WKM A line reconductoring options

High-level engineering and costing assessment of these options demonstrated that the simplex reconductoring option was almost as expensive as the two duplex reconductoring options, while offering significantly less capacity. Therefore, that simplex option was quickly discarded.

Duplex Zebra was slightly more expensive than Duplex Goat, while offering a better transfer capacity across the range of Bay of Plenty net load. Moreover, reconductoring with Duplex Zebra would lead to a 20 % smaller total resistance on the WRK–WKM A line compared with Duplex Goat. Over the lifetime of the conductor, the savings in grid losses would likely compensate the upfront investment cost difference. Therefore, the Duplex Zebra reconductoring was the only one shortlisted for further analysis with SDDP.

13.2 Option 6: Replacement of the WRK–WKM A line by a double circuit line

In this option, the whole WRK–WKM A line is replaced by a new double circuit line, strung with Duplex Sulfur AAAC at 100°C design sag temperature. In practice, the new line would be built first and connected to the substations, and then the existing line would be dismantled. The series reactor on the existing Atiamuri–Ohakuri 1 circuit would not be required once the new line is commissioned, hence it would be put in storage for a potential use elsewhere on the grid. Due to space constraints, it is not possible to bus the two 220 kV circuits of the new line at the Ohakuri substation. Therefore, two different topologies have been considered:

- bus one circuit of the new line at Ohakuri and have the second circuit bypassing Ohakuri (left on Figure 13 below).
- tee both 220 kV circuits of the new line into Ohakuri. This uses two 220 kV bays at Ohakuri, similarly to the previous option, but leads to the creation of two three-terminal circuits Atiamuri–Ohakuri –Wairakei (right on Figure 13).

The three-terminal option offers a better connectivity at Ohakuri and opens more opportunities in terms of line routes. Indeed, as Ohakuri will be connected as a double tee, a shorter line route between Wairakei and Atiamuri may be chosen for the high-capacity line, while a lower capacity deviation towards Ohakuri could be built. This could reduce the total length and impedance of the WRK–WKM A line by about 6%, which would improve the power flow distribution between the A line and the C line, hence increasing the maximum Wairakei Ring transfer capacity.

As no line route has been scoped at this stage, it is assumed for both options that each circuit of the new WRK–WKM A line would have the same length as the same circuit of the existing WRK–WKM A line.

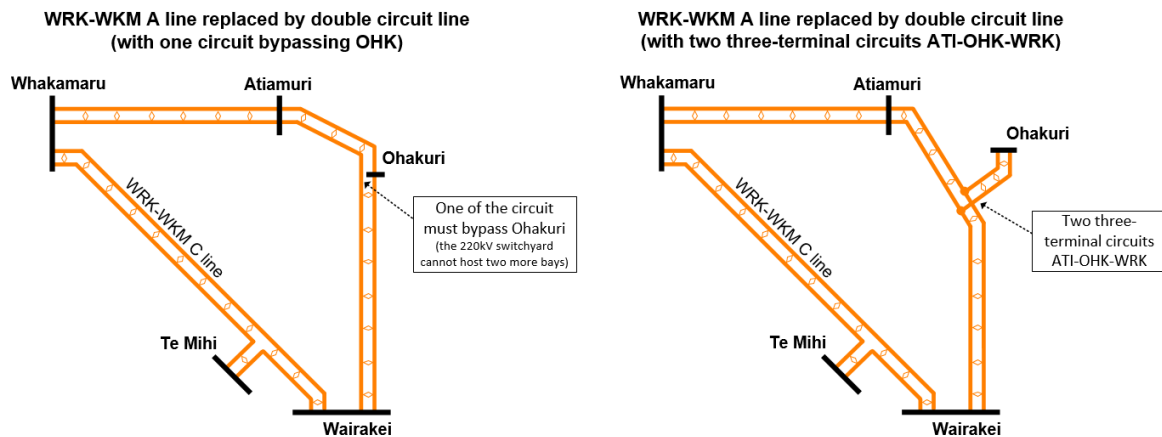

Figure 13: simplified transmission schematic of the options for the WRK–WKM A line replacement

As these options result in new circuits being commissioned, the list of contingency-monitor pairs needs to be updated accordingly, and the calculation of the maximum import at Whakamaru via the Wairakei Ring needs to consider the additional Atiamuri–Whakamaru 220 kV circuit. See Appendix F for details.

Figure 14 displays the maximum Wairakei Ring transfer capacity across the range of Bay of Plenty load–generation balance for the two WRK–WKM A line replacement configurations described above, with or without the TTU of the WRK–WKM C line implemented. It also shows how this maximum transfer capacity compares with the highest capacity WRK–WKM A line reconductoring option (Duplex Zebra at 120°C design sag temperature, orange line), and with the case where only the short-term upgrades are implemented (pink line).

The following observations can be made:

- The two different topologies for the WRK–WKM A line replacement offer exactly the same maximum Wairakei Ring transfer capacity. The transfer capacity remains relatively constant across the range of Bay of Plenty net load and is constrained by the WRK–WKM C line circuit capacity.
- The Wairakei Ring maximum transfer offered by the WRK–WKM A line replacement is about 2830 MW on average when the WRK–WKM C line implemented is completed. This is about 790 MW more than the Duplex Zebra reconductoring option and about 1530 MW more than the option with the short-term upgrades only.

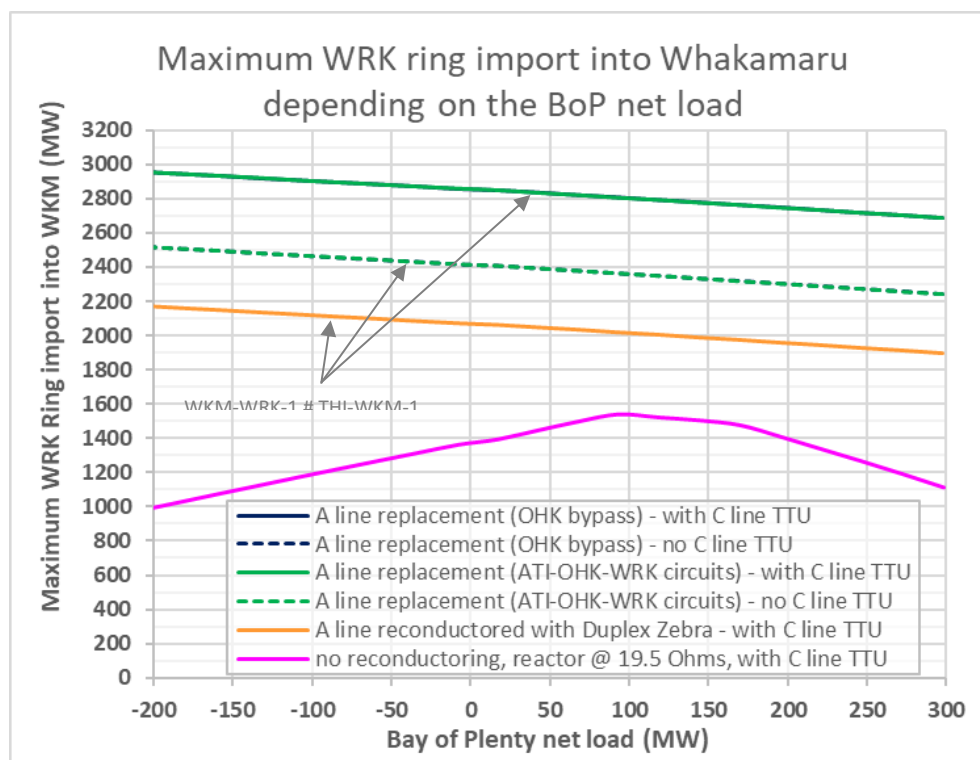

Figure 14: Wairakei Ring maximum transfer capacity – WRK–WKM A line replacement options

Besides the increased Wairakei Ring transfer capacity, replacing the WRK–WKM A line offers several other valuable benefits compared with reconducting this line:

- During planned outages on a Wairakei Ring circuit, the available transfer capacity from Wairakei to Whakamaru is significantly higher when the A line is replaced by a new double circuit line.
- The grid losses are further reduced when the A line is replaced by a new double circuit line, as one more low impedance circuit is available between Wairakei and Whakamaru.
- Replacing the WRK–WKM A line with a double circuit line would improve the security of supply of the whole Bay of Plenty region and facilitate further transmission upgrades to supply the region. With a single circuit A line, an outage of either the Atiamuri–Whakamaru 1 circuit or the Ohakuri–Wairakei circuit would leave the whole Bay of Plenty region on N security. Planned outages on any of these two circuits are currently managed by closing the Arapuni 110 kV bus split and dispatching enough generation in the region to ensure that its net total load can be supplied from Arapuni by the two Arapuni–Kinleith–Tarukenga 110 kV circuits, should the remaining 220 kV connection between the Bay of Plenty and the grid backbone trip. As the region continues to develop and the load increases, this approach might not be possible anymore in the future, and the consequences of a regional loss of supply will become higher and higher. The WRK–WKM A line replacement would turn Atiamuri and Ohakuri into more robust interface points between the grid backbone and the Bay of Plenty regional 220 kV grid, enabling further upgrades of this grid when required later in the future.
- Reconducting the WRK–WKM A line presents a major challenge in terms of planned outage requirements. About ten months of planned outages would be needed in total on the three circuit sections forming this line. Besides the impact on the Wairakei Ring transfer capacity, this would also mean extended periods with of reduced security of supply for the whole Bay of Plenty region (see previous bullet point). On the contrary, replacing the A line by a new double circuit line has very little planned outage requirements, as the new line can be built while the existing line is in service.

13.3 Option 7: Additional WRK–WKM double circuit line following direct route

In this option, an additional double circuit line strung with Duplex Sulfur at 100°C is built between Wairakei and Whakamaru, following the most direct possible route between these two substations (see simplified schematics on Figure 15). For this analysis it is assumed that this new line would have the same length as the WRK–WKM C line (40 km). In this option, it is proposed to keep the existing conductor on the WRK–WKM A line (and the Atiamuri series reactor on its highest impedance setting) until a condition-based replacement of the conductor is required in order to keep the investment cost as low as possible. If this option were to require a capacity upgrade of the A line in addition to the new line to deliver a significant Wairakei Ring transfer capacity increase, then reconductoring or replacing the A line would be preferable.

As this additional line would be about 30% shorter than a line replacing the A line, it is assumed that the total cost to build the additional line would be accordingly lower. This assumption is rather uncertain, as the total cost is heavily influenced by property costs for easements and access tracks, and those might differ on both line routes. A detailed line route analysis is required to accurately estimate the cost of those options.

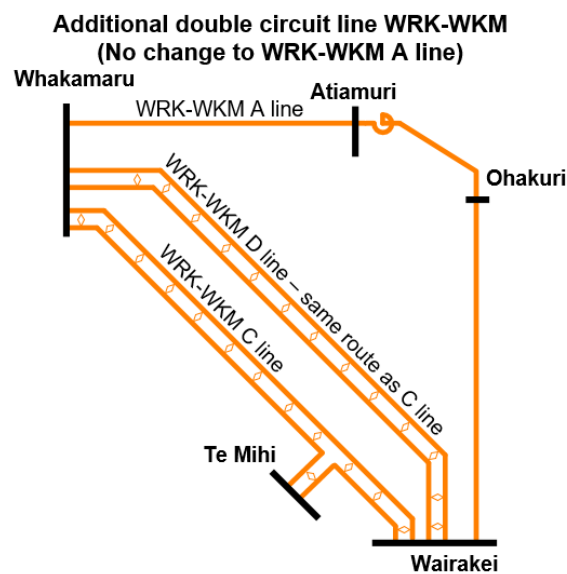

Figure 15: additional double circuit line in the Wairakei Ring – simplified schematics

As this option results in new circuits being commissioned, the list of contingency-monitor pairs needs to be updated accordingly, and the calculation of the maximum import at Whakamaru via the Wairakei Ring needs to consider the additional Whakamaru–Wairakei 220 kV circuit. See Appendix F for details.

Figure 16 displays the maximum Wairakei Ring transfer capacity across the range of Bay of Plenty load–generation balance when this additional WRK–WKM double circuit line is built, with and without the TTU of the WRK–WKM C line implemented (red lines). It also shows how this maximum transfer capacity compares with the case where only the short-term upgrades are implemented (pink line) and the other long-term options previously described in this section.

The following observations can be made:

- Out of all the options considered so far, building an additional WRK–WKM double circuit line offers the highest Wairakei Ring maximum transfer when the Bay of Plenty power import / export is low. For higher levels of Bay of Plenty import / export, the WRK–WKM A pre-contingency loading on the WRK–WKM A line is higher, and this line limits the Wairakei Ring maximum transfer to lower values than in the A line replacement option. During high Bay of Plenty power export periods, the Atiamuri–Whakamaru 1 circuit limits the Wairakei Ring transfer for a Te Mihi–Whakamaru 1 contingency. During high Bay of Plenty power import periods, the Atiamuri–Ohakuri 1 circuit is constraining for an Edgecumbe–Kawerau 3 circuit outage.

- When averaged across the range of Bay of Plenty net load, the additional line option and the A line replacement option offer very similar Wairakei ring transfer capacity (2823 MW vs 2829 MW). However, the A line replacement option offers a much more stable Wairakei Ring transfer capacity across the range of Bay of Plenty operating conditions, which is preferable.
- While thermally upgrading the WRK–WKM C line allows a significant Wairakei Ring transfer capacity increase when combined with the A line replacement or reconductoring options, its impact on increasing the Wairakei Ring transfer capacity offered by the additional line option is limited. This is because the transfer capacity is limited by the circuits of the WRK–WKM A line on most of the Bay of Plenty operating range.

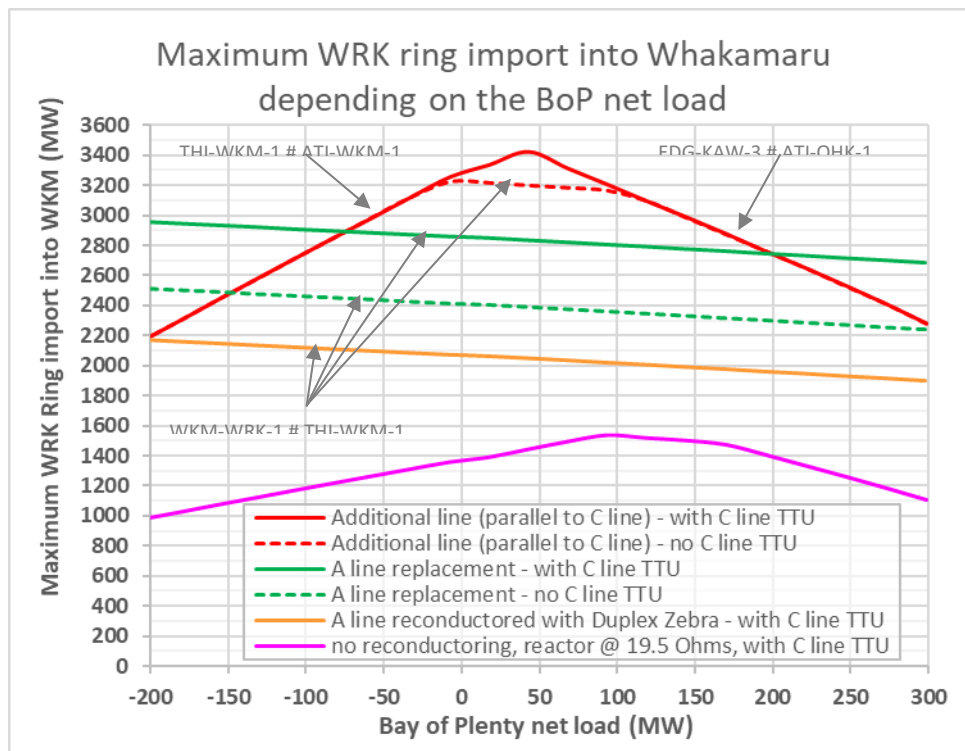

Figure 16: Wairakei Ring maximum transfer capacity – additional WRK–WKM line

Unlike the A line replacement option, building an additional direct line between Wairakei and Whakamaru does not improve the security of supply of the Bay of Plenty. While choosing a direct route for a new double circuit line in the Wairakei ring is likely cheaper than replacing the A line, it is potentially a missed opportunity to future-proof the regional Bay of Plenty supply while upgrading the grid backbone.

13.4 Option 8: mixed replacement / reconductoring of the WRK–WKM A line

This option was created with the intent of capturing most of the benefits of the WRK–WKM A line replacement option at a reduced cost. This can be done by limiting the A line replacement only to the section between Atiamuri and Wairakei (31.8 km), and reconductoring the existing line between Atiamuri and Whakamaru (23.8 km).

To prevent it from limiting the Wairakei Ring transfer capacity, the Atiamuri–Whakamaru line section needs to be reconductored with a higher capacity conductor than in the A line reconductoring option: duplex Pheasant at 120°C design sag temperature. The replacement line between Atiamuri and Wairakei will be a double circuit line strung with duplex Sulfur at 100°C design sag temperature, using the three-terminal Atiamuri–Ohakuri–Wairakei topology.

Similarly to the “full” A line replacement with a double circuit line, this option turns Atiamuri and Ohakuri into more robust interface points between the grid backbone and the Bay of Plenty regional 220 kV grid, enabling further upgrades of this grid when required.

As this option results in new circuits being commissioned, the list of contingency-monitor pairs needs to be updated accordingly (see Appendix F for details). However, this option does not add any new incoming circuit into Whakamaru.

Mixed option: Duplex ATI-WKM, replace ATI-OHK-WRK with double circuit line

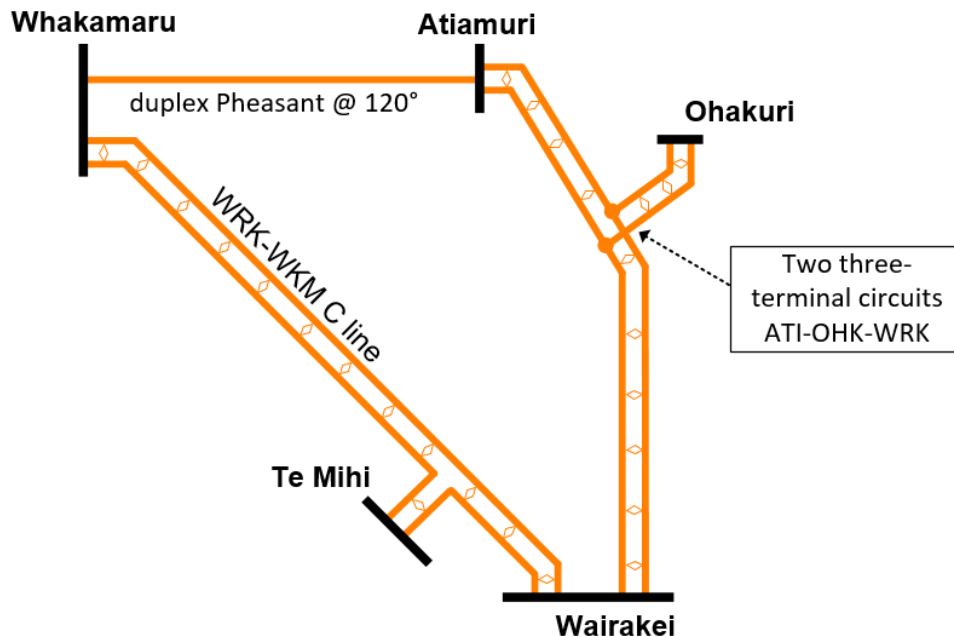

Figure 17: mixed replacement / reconductoring of the WRK–WKM A line–simplified schematics

Figure 18 displays the maximum Wairakei Ring transfer capacity across the range of Bay of Plenty load–generation balance for this option combining replacement and reconductoring of the WRK–WKM A line, with and without the TTU of the WRK–WKM C line implemented (blue lines). It also shows how this maximum transfer capacity compares with the case where only the short-term upgrades are implemented (pink line) and the other long-term options previously described in this section.

The following observations can be made:

- The “A line mixed replacement / reconductoring” option delivers about 2310 MW of Wairakei Ring transfer capacity on average across the range of Bay of Plenty operating conditions (when combined with the WRK–WKM C line TTU). This is about 270 MW more than the best reconductoring option (orange line), and about 510 MW less than the “full A line replacement” option and the “additional WRK–WKM line” option.
- When compared with the option when the whole A line is replaced by a new double circuit line, having only one high-capacity circuit between Atiamuri and Whakamaru causes a significant reduction of the maximum Wairakei Ring transfer capacity.

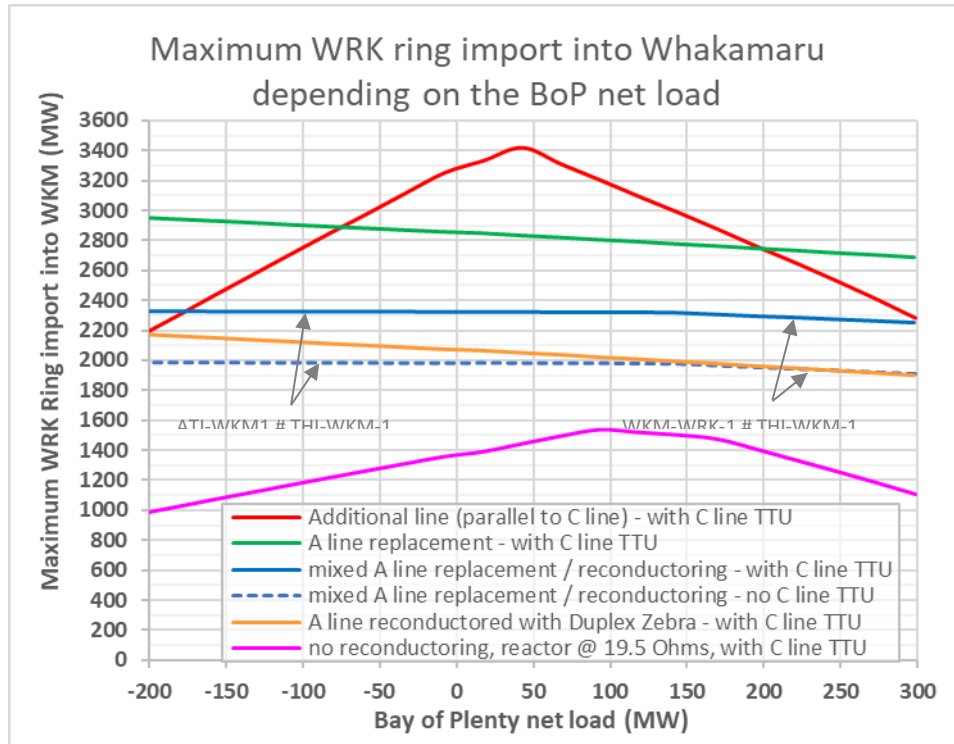

Figure 18: Wairakei Ring maximum transfer capacity – mixed replacement / reconductoring of the A line

14 Comparison of the options during planned outages

In this chapter, the Wairakei Ring transfer capacities of the main options described above will be compared, with a specific focus on transfer capacity during planned outages. Although planned circuit outages occur only a few days per year on average, they are essential to ensure good asset performance in the long-term. Generally, planned outages lead to a reduction of the transfer capacity in a transmission corridor, as there are fewer remaining circuits available to transfer power, and less redundancy. During planned outages on the grid backbone, the N-1 security criteria still needs to be respected, which can cause generation constraints if the transmission capacity is insufficient.

Figure 19 illustrates the main options considered in this study, and compares their maximum Wairakei Ring transfer capacity in three scenarios:

- N situation (all circuits available – blue trend on graphs)
- planned circuit outage on the WRK–WKM A line (orange trend on graphs)
- planned circuit outage on the WRK–WKM C line (green trend on graphs)

Table 22 sums up the Wairakei Ring transfer capacity offered by each option in these three scenarios, averaged across the whole range of Bay of Plenty net load between -200 MW and 200 MW.

The following points of interest are noted:

- As discussed in section 12.5, the preferred short-term grid upgrades do not deliver any improvement in terms of transfer capacity available during a planned circuit outage on the C line. The transfer capacity is capped around 390-430 MW by the low capacity of the A line.
- The reconductoring of the A line with duplex Zebra at 120° increases the transfer capacity during a planned circuit outage on the C line by about 150 %, as the transmission capacity of the A line increases accordingly. The transfer capacity during an A line planned circuit outage remains the same because this option still offers only one circuit on the A line and the transmission capacity of the C line circuits remain the same as in the previous option. Overall, this option results in relatively similar transfer capacities for both planned outage scenarios (about 1225 MW for an A line planned circuit outage and about 1040 MW during a C line planned circuit outage)
- The replacement of the A line by a new double circuit line leads to a major increase of the Wairakei Ring transfer capacity in all situations. Having four circuits all strung with high-capacity conductors in the Wairakei Ring ensures high transfer capacity in N situation and for all N-1 situations. It also ensures that the offered transfer capacity remains consistent across the range of Bay of Plenty operating conditions, and that any planned outage only leads to a smaller transfer capacity reduction compared with the other options. A smaller difference in transfer capacities between N and N-1 situations should ensure that generation that can be dispatched in N situation is less likely to be constrained during planned circuit outages in the Wairakei Ring.
- Adding a new high-capacity direct line between Wairakei and Whakamaru while keeping the low-capacity A line unchanged offers variable performance depending on the Bay of Plenty operating conditions and which circuit is on planned outage. During a single circuit outage on the A line, the transfer capacity is higher than in N situation most of the time, which confirms that the A line is limiting the benefits of this option. On the other hand, when a single circuit outage is planned on the C line or on the additional line, the transmission constraints caused by the A line occur much earlier and this option offers a mostly lower transfer capacity than the “full A line replacement” option in this specific situation.

The “A line mixed replacement / reconductoring” option delivers a significantly lower transfer capacity during planned circuit outages than the “full A line replacement” option (about 1000 MW lower). This is because this mixed option does not add a second high-capacity circuit between Atiamuri and Whakamaru. This also explains why the transfer capacity during planned circuit outages of this mixed option is very similar to the transfer capacity of the A line reconductoring option, even though the A line is replaced by a double circuit line between Wairakei and Atiamuri. Overall, the gain in Wairakei Ring transfer capacity offered by the “full A line replacement” option might justify its additional cost compared with this “A line mixed replacement / reconductoring” option.

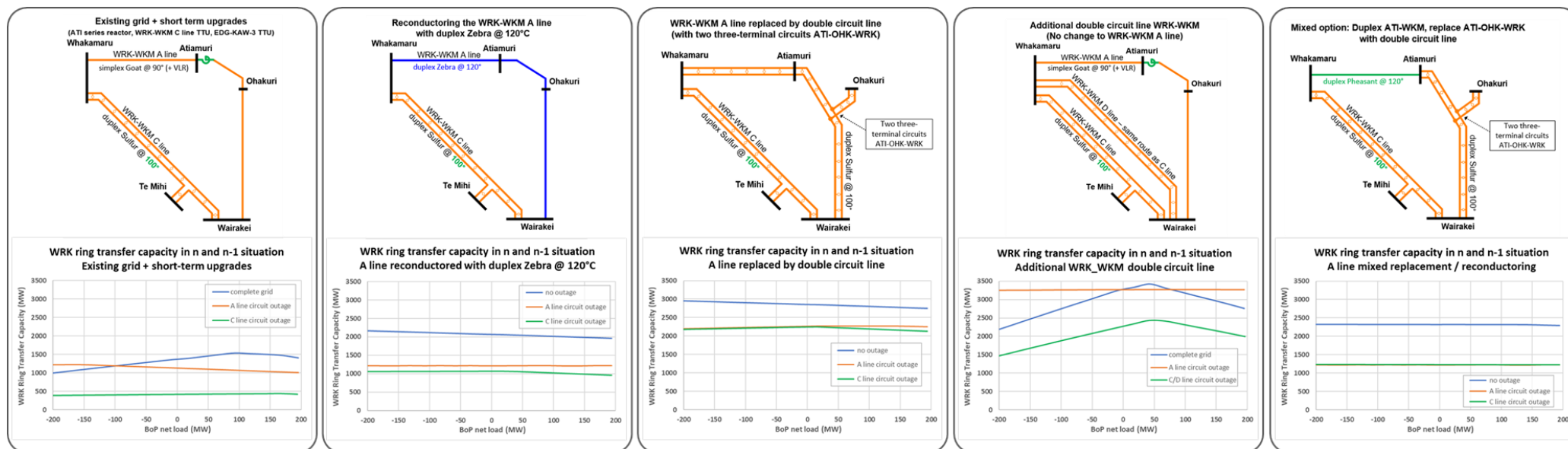

Figure 19: Comparison of the Wairakei Ring maximum transfer capacity in N situation and planned N-1 situations for the main upgrade options studied

Table 22: Average Wairakei Ring transfer capacity across the Bay of Plenty net load range for the main upgrade options, in N situation and planned N-1 situations

Option description	Average WRK Ring maximum transfer capacity across BoP net load range [-200 MW, 200 MW] in following grid configuration (MW)		
	All circuits available	Single circuit outage on A line	Single circuit outage on C line
	Existing grid + ATI series reactor 19.5 ohms + TTUs (C line & EDG-KAW-3)	1315	1224
Reconductor A line with duplex Zebra @ 120°C + TTUs	2070	1224	1039
Replace A line with double circuit line + TTUs	2857	2249	2199
Additional WRK-WKM line (direct route) with A line unchanged + TTUs	2906	3262	2036
A line mix replacement / reconductor + TTUs	2321	1224	1228

15 Conclusion

Short-term options and long-term options have been assessed to increase the transfer capacity through the Wairakei Ring.

Short-term Option Analysis Results

The following combination of preferred upgrades has been identified and these increase the average transfer capacity across the range of Bay of Plenty operating conditions by about 293 MW:

- TTU of the Edgumbe–Kawerau 3 220kV circuit to 90°C design sag temperature
- TTU of the Wairakei–Whakamaru C line to 100°C design sag temperature

While these upgrades deliver a noticeable Wairakei Ring transfer capacity increase when the Bay of Plenty imports power from the grid backbone (which currently happens about 80% to 90% of the time), they have no impact on the transfer capacity when the Bay of Plenty exports power to the grid backbone. If this becomes the dominant scenario, a split of the Atiamuri 220 kV bus could be considered as a way to increase the Wairakei Ring maximum transfer capacity under these conditions, but this will happen at the expense of a reduced transfer capability during Bay of Plenty net import and increased grid losses. At this stage, it is not proposed to implement this bus split. If such a large shift of import/export behaviour occurs in the Bay of Plenty, a more significant grid upgrade of the WRK–WKM A line will most likely be required. In this case, the Atiamuri 220 kV bus split could act a temporary option to increase capacity until that more consequent grid upgrade is commissioned.

Furthermore, these short-term upgrades also do not address the low Wairakei Ring transfer capacity issue during planned circuit outages on the WRK–WKM C line. In this situation, generation constraints will be extremely likely in the future even with careful outage coordination between transmission and generation assets in the area.

Long-term Option Analysis Results

An assessment of long-term options has been performed; it is assumed the long-term options could be implemented in the next 10 to 20 years to increase thermal transfer through the Wairakei Ring.

The transfer capacity increase for various options is shown in Table 15. For all these long-term options, it is assumed that the proposed short-term options have been implemented.

- Option 5 (reconductoring the WRK–WKM A line) is potentially the lowest-cost long-term option and delivers on average slightly more than 1000 MW of transfer capacity increase. The main drawbacks of this option are the extensive planned outages required for its implementation (10 months in total), the comparatively higher grid losses and lower transfer capacity during planned outages. This option also does not improve the Bay of Plenty security of supply, unlike Options 6 and 8.
- Option 6 (replacing the WRK–WKM A line is replaced by a new double circuit line strung with duplex Sulfur AAAC at 100°C sag) delivers the overall highest transfer capacity). Another key benefit of this option (compared with Options 5 and 7) is that replacing the WRK–WKM A line by a double circuit line would transform Atiamuri and Ohakuri into more robust interface points between the grid backbone and the Bay of Plenty regional grid, enabling further upgrades of this grid when required later in the future.
- Option 7 (additional double circuit line between Wairakei and Whakamaru) also delivers a significant capacity increase, but this increase is less consistent across the range of Bay of

Plenty net load due to capacity limitations on the WRK–WKM A line, that remains unchanged in this option. Option 7 does not perform as well as Option 6 in terms of transfer capacity, especially during periods of high Bay of Plenty import or export, and during planned outages on a C line circuit. It also does not improve the Bay of Plenty security of supply, contrarily to Option 6 and 8.

- Option 8 (mixed reconductoring and replacement of the WRK–WKM A line) was created with the intent of delivering most of the benefits of Option 6 at a lower cost. The analysis indicates that the transfer capacity offered by this option is significantly lower (about 500 MW) than Option 6. Transfer capacity during planned circuit outages is also low, comparable to what Option 5 would offer.

Table 23: Transfer capacity increase for different options (MW)

Option No.	Bay of Plenty net load (MW)						Average
	-200	-100	0	100	200	300	
Option 5	1189	948	735	827	1216	1646	1037
Option 6	1975	1734	1523	1614	2002	2433	1824
Option 7	1184	1540	1918	2013	2015	2029	1818
Option 8	1345	1151	985	1127	1550	1999	1306
0-5 Year Preferred Short Term Option	0	0	25	348	665	857	293
Base case	0	0	0	0	0	0	0

Appendix F Contingency-monitor pairs and circuits considered in transfer capacity calculation

The table below displays the list of contingency monitor pairs considered in this study and specifies for which option(s) this pair is relevant. Duplicates have been removed when several parallel circuits have the same impedance.

Contingency	Monitor	relevant for following options
ATI-OHK-1	EDG-KAW-3	All options
ATI-OHK-1	THI-WKM-1	All options
ATI-OHK-1	WKM-WRK-1	All options
ATI-WKM-1	THI-WKM-1	All options
ATI-WKM-1	WKM-WRK-1	All options
EDG-KAW-3	ATI-OHK-1	All options
EDG-KAW-3	ATI-TRK-1	All options
EDG-KAW-3	ATI-TRK-1	All options
EDG-KAW-3	THI-WKM-1	All options
EDG-KAW-3	WKM-WRK-1	All options
OHK-WRK-1	THI-WKM-1	All options
OHK-WRK-1	WKM-WRK-1	All options
THI-WKM-1	ATI-OHK-1	All options
THI-WKM-1	ATI-WKM-1	All options
THI-WKM-1	EDG-KAW-3	All options
THI-WKM-1	WKM-WRK-1	All options
WKM-WRK-1	ATI-OHK-1	All options
WKM-WRK-1	ATI-WKM-1	All options
WKM-WRK-1	EDG-KAW-3	All options
WKM-WRK-1	THI-WKM-1	All options
ATI-WKM-1	ATI-WKM-2	Option 6
ATI-WRK-1	OHK-WRK-1	Option 6 (OHK bypass)
ATI-WRK-1	ATI-OHK-1	Option 6 (OHK bypass)
ATI-WRK-1	ATI-WKM-1	Option 6 (OHK bypass)
OHK-WRK-1	ATI-WKM-1	Option 6 (OHK bypass)
ATI-OHK-WRK-1	ATI-OHK-WRK-2	Option 6 (3-terminal cct) and 8
ATI-OHK-WRK-1	THI-WKM-1	Option 6 (3-terminal cct) and 8
ATI-OHK-WRK-1	ATI-WKM-1	Option 6 (3-terminal cct) and 8
WKM-WRK-1	WKM-WRK-2	Option 7

Appendix F: Contingency-monitor pairs and circuits considered in transfer capacity calculation

The table below lists the circuits that were considered to calculate the Wairakei Ring transfer capacity for the relevant option(s). The Wairakei Ring transfer capacity was defined as the sum of the incoming active flows into Whakamaru across all circuits in the table below relevant for each option.

Wairakei Ring circuit incoming at Whakamaru	relevant for following options
THI-WKM-1	All options
WKM-WRK-1	All options
ATI-WKM-1	All options
ATI-WKM-2	Option 6
WKM-WRK-2	Option 7
WKM-WRK-3	Option 7

Appendix G Generation dispatch

The table below details for each generator the active power output considered for this analysis. The maximum active power is also specified. All wind generators were dispatched at 20% of their installed capacity.

Generator	Dispatched active power (MW)	Maximum active power (MW)
ANI-G1	11.9	12.5
ANI-G2	11.9	12.5
ARA-G1	24.8	27.0
ARA-G2	24.8	30.0
ARA-G3	24.8	30.0
ARI-G1	21.4	22.5
ARI-G2	21.4	22.5
ARI-G3	21.4	22.5
ARI-G4	21.4	22.5
ARI-G5	25.6	27.0
ARI-G6	24.4	27.0
ARI-G7	24.4	27.0
ARI-G8	24.4	27.0
ATI-G1	19.0	20.0
ATI-G2	19.0	20.0
ATI-G3	19.0	20.0
ATI-G4	19.0	20.0
GLN-G1	15.0	18.8
GLN-G2	15.0	18.8
GLN-G3	34.3	74.3
GLN-M1	2.0	3.4
HAY-C1	0.0	1.0
HAY-C10	0.0	1.0
HAY-C2	0.0	1.0
HAY-C3	0.0	1.0
HAY-C4	0.0	1.0
HAY-C7	0.0	1.0
HAY-C8	0.0	1.0
HAY-C9	0.0	1.0
HLY-UN1	0.0	250.0
HLY-UN2	0.0	250.0
HLY-UN4	0.0	250.0
HLY-UN5	390.0	400.0
HLY-UN6	50.0	50.0
JRD-G1	50.0	52.0
JRD-G2	50.0	52.0
KA24	8.8	9.0
KAG-G1	103.9	106.0
KIN-G1	19.0	39.6

Appendix G : Generation dispatch

KPI-G1	10.0	11.0
KPI-G2	10.0	12.5
KPO-G1	35.6	35.6
KPO-G2	35.6	35.6
KPO-G3	35.6	35.6
KTW-G6	17.1	18.0
KTW-G7	17.1	18.0
LMD-G1	7.3	7.7
LMD-G2	7.3	7.7
MAT-G1	38.0	40.0
MAT-G2	38.0	40.0
MHO-G1	25.5	27.0
MHO-G2	0.0	5.7
MHO-G3	0.0	5.7
MKE-G1	47.0	47.0
MKE-G2	47.0	47.0
MOK-G1	4.3	4.5
MOK-G10	39.2	45.6
MOK-G11	4.3	4.5
MOK-G12	4.3	4.5
MOK-G2	4.3	4.5
MOK-G21	4.3	4.5
MOK-G22	4.3	4.5
MOK-G3	6.9	8.2
MOK-G30	18.6	21.5
MOK-G31	5.9	8.2
MOK-G32	5.9	8.2
MOK-G41	4.9	7.3
MPA-G1	5.3	5.6
MTI-G1	34.2	36.0
MTI-G10	34.2	36.0
MTI-G2	34.2	36.0
MTI-G3	34.2	36.0
MTI-G4	34.2	36.0
MTI-G5	34.2	36.0
MTI-G6	34.2	36.0
MTI-G7	34.2	36.0
MTI-G8	34.2	36.0
MTI-G9	34.2	36.0
NAP-G1	135.2	138.0
NBG	4.9	5.0
NGA-G1	4.9	5.0
NGA-G2	14.7	15.8
NGA-G3	29.4	31.6
NTM-G1	21.6	23.8
NTM-G2	21.6	23.8

Appendix G : Generation dispatch

NTM-G3	21.6	23.8
NTM-G4	21.6	23.8
OHK-G1	26.6	28.0
OHK-G2	26.6	28.0
OHK-G3	26.6	28.0
OHK-G4	26.6	28.0
OKI-UN1	47.0	48.0
OKI-UN2	0.0	46.0
PPI-G1	50.0	55.0
PRI-G4	20.9	23.6
PRI-G5	20.9	23.6
PTA-G1	5.5	11.2
PTA-G2	5.5	11.2
PTA-G3	5.5	11.2
RHI-G1	9.2	9.7
RHI-G2	9.2	9.7
RKA-G1	14.7	15.0
RKA-G2	4.9	5.0
RKA-G3	4.9	5.0
RKA-G4	4.9	5.0
RKA-G5	4.9	5.0
RPO-G5	57.0	65.0
RPO-G6	57.0	65.0
SFD-G21	100.0	110.0
SFD-G22	100.0	110.0
SPL-CCGT	380.0	383.0
T/A_2	16.0	16.0
T/A_3	9.3	9.5
TAA-G1	14.2	14.9
TAA-G2	14.2	14.9
TAOM	23.5	24.3
THI-G1	81.3	91.9
THI-G2	81.3	91.9
TKU-G1	57.0	60.0
TKU-G2	57.0	60.0
TKU-G3	57.0	60.0
TKU-G4	57.0	60.0
TOPP1	23.0	23.8
TRA-G1	149.0	177.4
TRC	18.9	50.0
TUI-G1	19.0	20.0
TUI-G2	19.0	20.0
TUI-G3	19.0	20.0
WAA-G1	3.9	10.0
WAA-G10	10.9	28.6
WAA-G2	3.9	10.0

Appendix G : Generation dispatch

WAA-G3	3.9	10.0
WAA-G4	3.9	10.0
WHE-G1	11.9	12.0
WHE-G2	11.9	12.0
WHI-G1	0.0	52.0
WHI-G2	0.0	52.0
WHI-G3	0.0	52.0
WKM-G1	29.9	31.0
WKM-G2	29.9	31.0
WKM-G3	29.9	31.0
WKM-G4	29.9	31.0
WPA-G1	16.1	18.8
WPA-G2	16.1	18.8
WPA-G3	16.1	18.8
WRK-UN1	10.3	12.4
WRK-UN10	10.3	12.4
WRK-UN11	28.4	33.3
WRK-UN12	28.4	33.3
WRK-UN13	28.4	33.3
WRK-UN15	3.9	4.2
WRK-UN16	6.9	10.0
WRK-UN4	10.3	12.4
WRK-UN7	10.3	12.4
WRK-UN8	10.3	12.4
WRK-UN9	10.3	12.4

Appendix H Line parameters

The transmission line parameters used for the different upgrade options are detailed in the table below:

Rating #	Circuit	Conductor	R1 [ohm]	X1 [ohm]	C1 [uF]	R0 [ohm]	X0 [ohm]	C0 [uF]	Length [m]	Winter [kA]	Shoulder [kA]	Summer [kA]
1	ATI-OHK-1	duplex GoatAC @120°C	0.2448	1.8346	0.0685	1.1237	5.1149	0.0399	5936	2.266	2.214	2.160
2	ATI-OHK-1	duplex ZebraAC @120°C	0.1919	1.8193	0.0692	1.0707	5.1009	0.0401	5936	2.640	2.579	2.516
3	ATI-OHK-1	simplex Chukar Mod AC @ 120°C	0.1898	2.3764	0.0537	1.0686	5.6592	0.0344	5936	2.101	2.054	2.004
4	ATI-OHK-1	duplex Sulfur AAAC @ 100°C	0.1320	1.8042	0.0702	1.0108	5.1669	0.0363	5936	3.067	2.978	2.883
5	ATI-OHK-2	duplex Sulfur AAAC @ 100°C	0.1320	1.8042	0.0702	1.0108	5.1669	0.0363	5936	3.067	2.978	2.883
6	ATI-WKM-1	duplex GoatAC @120°C	0.9817	7.3754	0.2740	4.5054	15.859	0.1846	23802	2.266	2.214	2.160
7	ATI-WKM-1	duplex ZebraAC @120°C	0.7693	7.3142	0.2768	4.2930	15.8026	0.1859	23802	2.640	2.579	2.516
8	ATI-WKM-1	simplex Chukar Mod AC @ 120°C	0.7609	9.5479	0.2147	4.2846	18.0411	0.1557	23802	2.101	2.054	2.004
9	ATI-WKM-1	duplex Pheasant AC @ 120°C	0.5120	7.1621	0.2829	4.0357	15.6505	0.1886	23802	3.454	3.375	3.293
10	ATI-WKM-1	duplex Sulfur AAAC @ 100°C	0.5291	7.2338	0.2813	4.0528	20.7166	0.1455	23802	3.067	2.978	2.883
11	ATI-WKM-2	duplex Sulfur AAAC @ 100°C	0.5291	7.2338	0.2813	4.0528	20.7166	0.1455	23802	3.067	2.978	2.883
12	ATI-WRK-1	duplex Sulfur AAAC @ 100°C	0.7064	9.6582	0.3756	5.4111	27.6595	0.1943	31779	3.067	2.978	2.883
13	EDG-KAW-3	simplex Zebra GZ @ 90°C	1.5317	9.3133	0.2000	4.8941	22.7500	0.1205	22715	1.113	1.075	1.035
14	OHK-WRK-1	duplex GoatAC @120°C	1.0659	7.9971	0.2979	4.8917	22.263	0.1812	25842	2.266	2.214	2.160
15	OHK-WRK-1	duplex ZebraAC @120°C	0.8352	7.9307	0.3010	4.6610	22.2018	0.1823	25842	2.640	2.579	2.516
16	OHK-WRK-1	simplex Chukar Mod AC @ 120°C	0.8262	10.3559	0.2334	4.6520	24.6323	0.1551	25842	2.101	2.054	2.004
17	OHK-WRK-1	duplex Sulfur AAAC @ 100°C	0.5745	7.8540	0.3055	4.4003	22.4927	0.1580	25842	3.067	2.978	2.883
18	OHK-WRK-2	duplex Sulfur AAAC @ 100°C	0.5745	7.8540	0.3055	4.4003	22.4927	0.1580	25842	3.067	2.978	2.883
19	THI-WKM-1	duplex Sulfur AAAC @ 100°C	0.7635	10.1939	0.4158	5.8462	29.1482	0.2037	34090	3.067	2.978	2.883
20	THI-WRK-1	duplex Sulfur AAAC @ 100°C	0.1196	1.5933	0.0653	0.9160	4.5300	0.0315	5134	3.067	2.978	2.883

Appendix H : Line parameters

21	WKM-WRK-1	duplex Sulfur AAAC @ 100°C	0.8942	11.9348	0.4873	6.8480	34.0200	0.2379	40220	3.067	2.978	2.883
22	WKM-WRK-2	duplex Sulfur AAAC @ 100°C	0.8942	11.9348	0.4873	6.8480	34.0200	0.2379	40220	3.067	2.978	2.883
23	WKM-WRK-3	duplex Sulfur AAAC @ 100°C	0.8942	11.9348	0.4873	6.8480	34.0200	0.2379	40220	3.067	2.978	2.883

This second table details which rating parameters have been used for each grid upgrade option. The rating # mentioned in the third column refers to the rating # in the previous table. For all the long-term options (5, 6, 7, 8), the short-term upgrades considered in Options 1 and 2 have been included.

Option Number	Description	Rating # Used
1	TTU of the Edgcumbe – Kawerau 3 circuit to 90°C design sag temperature	13
2	TTU of the Wairakei – Whakamaru C line to 100°C design sag temperature (With TTU of the Edgcumbe – Kawerau 3 circuit)	19,20,21 (13)
5	Reconductoring of the WRK–WKM A line <ul style="list-style-type: none"> • simplex Chukar Mod AC at 120°C design sag temperature • duplex Goat AC at 120°C design sag temperature • duplex Zebra AC at 120°C design sag temperature 	(13,19,20,21) • 3,8,16 • 1,6,14 • 2,7,15
6	Replace WRK–WKM A line by new double circuit line strung with duplex Sulfur AAAC at 100°C design sag temperature. Two configurations considered: <ul style="list-style-type: none"> • one circuit bypasses Ohakuri (ATI-WRK-1, ATI-OHK-1, OHK-WRK-1) • two three-terminal circuits ATI-OHK-WRK 1 & 2 	(13,19,20,21) • 4,10,11,12,17 • 4,5,10,11,17,18
7	Additional direct double circuit line between Wairakei and Whakamaru, strung with duplex Sulfur AAAC at 100°C design sag temperature. The length and impedance of the new WRK–WKM circuits on this line are assumed to be the same as the existing WRK-WKM-1 circuit. In this option the circuits on the WRK–WKM A line are not upgraded.	(13,19,20,21) 22,23
8	Mixed replacement / reconductoring of the WRK–WKM A line Between Atiamuri and Wairakei, the A line is replaced by a double circuit line strung with duplex Sulfur AAAC at 100°C design sag temperature (configuration with two three-terminal circuits ATI-OHK-WRK 1 & 2. Between Atiamuri and Whakamaru, the A line is reconducted with duplex Pheasant AC at 120°C design sag temperature	(13,19,20,21) 9,10,11,17,18

